



**MIPS® Architecture for Programmers
Volume II-A: The MIPS32® Instruction
Set Manual**

Document Number: MD00086

Revision 6.05

May 20, 2016

Public. This publication contains proprietary information which is subject to change without notice and is supplied 'as is', without any warranty of any kind.

Table of Contents

Chapter 1: About This Book	2
1.1: Typographical Conventions	3
1.1.1: Italic Text	3
1.1.2: Bold Text	3
1.1.3: Courier Text	3
1.2: UNPREDICTABLE and UNDEFINED	3
1.2.1: UNPREDICTABLE	3
1.2.2: UNDEFINED	4
1.2.3: UNSTABLE	4
1.3: Special Symbols in Pseudocode Notation	4
1.4: Notation for Register Field Accessibility	7
1.5: For More Information	9
Chapter 2: Guide to the Instruction Set	10
2.1: Understanding the Instruction Fields	10
2.1.1: Instruction Fields	12
2.1.2: Instruction Descriptive Name and Mnemonic	12
2.1.3: Format Field	12
2.1.4: Purpose Field	13
2.1.5: Description Field	13
2.1.6: Restrictions Field	13
2.1.7: Availability and Compatibility Fields	14
2.1.8: Operation Field	15
2.1.9: Exceptions Field	15
2.1.10: Programming Notes and Implementation Notes Fields	15
2.2: Operation Section Notation and Functions	16
2.2.1: Instruction Execution Ordering	16
2.2.2: Pseudocode Functions	16
2.3: Op and Function Subfield Notation	27
2.4: FPU Instructions	27
Chapter 3: The MIPS32® Instruction Set	29
3.1: Compliance and Subsetting	29
3.1.1: Subsetting of Non-Privileged Architecture	29
3.2: Alphabetical List of Instructions	31
ABS.fmt	32
ADD	33
ADD.fmt	34
ADDI	35
ADDIU	36
ADDIUPC	37
ADDU	38
ALIGN	39
ALNV.PS	41
ALUIPC	43
AND	44
ANDI	45

AUI	47
AUIPC	48
B	49
BAL.....	50
BALC	52
BC	53
BC1EQZ BC1NEZ.....	54
BC1F	56
BC1FL.....	58
BC1T	60
BC1TL.....	62
BC2EQZ BC2NEZ.....	64
BC2F	66
BC2FL.....	67
BC2T	69
BC2TL.....	70
BEQ.....	72
BEQL.....	73
BGEZ.....	75
BGEZAL	76
B{LE,GE,GT,LT,EQ,NE}ZALC	77
BGEZALL	80
B<cond>C	82
BGEZL.....	86
BGTZ.....	88
BGTZL.....	89
BITSWAP	91
BLEZ	93
BLEZL	94
BLTZ.....	96
BLTZAL	97
BLTZALL	98
BLTZL.....	100
BNE	102
BNEL.....	103
BOVC BNVC	105
BREAK	107
C.cond.fmt	108
CACHE.....	112
CACHEE	119
CEIL.L.fmt	125
CEIL.W.fmt.....	126
CFC1	127
CFC2.....	129
CLASS.fmt.....	130
CLO	132
CLZ.....	133
CMP.condn.fmt.....	134
COP2.....	139
CTC1	140
CTC2.....	143
CVT.D.fmt.....	144
CVT.L.fmt	145

CVT.PS.S	146
CVT.S.PL	148
CVT.S.PU	149
CVT.S.fmt.....	150
CVT.W.fmt.....	151
DDIV.....	152
DDIVU	153
DERET	154
DI.....	155
DIV	156
DIV MOD DIVU MODU	158
DIV.fmt	160
DIVU.....	161
DVP	162
EHB	165
EI	166
ERET.....	167
ERETNC.....	169
EVP	171
EXT	173
FLOOR.L.fmt.....	175
FLOOR.W.fmt.....	176
INS	177
J.....	179
JAL	180
JALR.....	181
JALR.HB.....	183
JALX.....	187
JIALC.....	189
JIC	191
JR	192
JR.HB	194
LB	197
LBE.....	198
LBU	199
LBUE	200
LDC1	201
LDC2	202
LDXC1	204
LH.....	205
LHE	206
LHU	207
LHUE.....	208
LL	209
LLE	211
LLWP.....	213
LLWPE	215
LSA	217
LUI.....	218
LUXC1	219
LW	220
LWC1	221
LWC2	222

LWE.....	224
LWL.....	225
LWLE.....	227
LWPC.....	230
LWR.....	231
LWRE.....	234
LWXC1.....	237
MADD.....	238
MADD.fmt.....	239
MADDF.fmt MSUBF.fmt.....	242
MADDU.....	244
MAX.fmt MIN.fmt MAXA.fmt MINA.fmt.....	245
MFC0.....	249
MFC1.....	250
MFC2.....	251
MFHC0.....	252
MFHC1.....	253
MFHC2.....	254
MFHI.....	255
MFLO.....	256
MOV.fmt.....	257
MOVF.....	258
MOVF.fmt.....	259
MOVN.....	261
MOVN.fmt.....	262
MOVT.....	263
MOVT.fmt.....	264
MOVZ.....	266
MOVZ.fmt.....	267
MSUB.....	268
MSUB.fmt.....	269
MSUBU.....	271
MTC0.....	272
MTC1.....	274
MTC2.....	275
MTHC0.....	276
MTHC1.....	277
MTHC2.....	278
MTHI.....	279
MTLO.....	280
MUL.....	281
MUL MUH MULU MUHU.....	282
MUL.fmt.....	284
MULT.....	285
MULTU.....	286
NAL.....	287
NEG.fmt.....	288
NMADD.fmt.....	289
NMSUB.fmt.....	291
NOP.....	293
NOR.....	294
OR.....	295
ORI.....	296

PAUSE	298
PLL.PS	300
PLU.PS	301
PREF	302
PREFE	306
PREFX	310
PUL.PS	311
PUU.PS	312
RDHWR	313
RDPGPR	316
RECIP.fmt	317
RINT.fmt	318
ROTR	320
ROTRV	321
ROUND.L.fmt	322
ROUND.W.fmt	323
RSQRT.fmt	324
SB	325
SBE	326
SC	327
SCE	330
SCWP	333
SCWPE	335
SDBBP	338
SDC1	339
SDC2	340
SDXC1	341
SEB	342
SEH	343
SEL.fmt	344
SELEQZ SELNEZ	346
SELEQZ.fmt SELNEQZ.fmt	348
SH	350
SHE	351
SIGRIE	353
SLL	354
SLLV	355
SLT	356
SLTI	357
SLTIU	358
SLTU	359
SQRT.fmt	360
SRA	361
SRAV	362
SRL	363
SRLV	364
SSNOP	365
SUB	366
SUB.fmt	367
SUBU	368
SUXC1	369
SW	370
SWC1	371

SWC2	372
SWE	373
SWL	374
SWLE	377
SWR	379
SWRE	382
SWXC1	384
SYNC	385
SYNCI	390
SYSCALL	393
TEQ	394
TEQI	395
TGE	396
TGEI	397
TGEIU	398
TGEU	399
TLBINV	400
TLBINVF	403
TLBP	405
TLBR	406
TLBWI	408
TLBWR	410
TLT	412
TLTI	413
TLTIU	414
TLTU	415
TNE	416
TNEI	417
TRUNC.L.fmt	418
TRUNC.W.fmt	419
WAIT	420
WRPGPR	422
WSBH	423
XOR	424
XORI	425

Appendix A: Instruction Bit Encodings	426
A.1: Instruction Encodings and Instruction Classes	426
A.2: Instruction Bit Encoding Tables	426
A.3: Floating Point Unit Instruction Format Encodings	437
A.4: Release 6 Instruction Encodings	439
Appendix B: Revision History	444

List of Figures

Figure 2.1: Example of Instruction Description	11
Figure 2.2: Example of Instruction Fields	12
Figure 2.3: Example of Instruction Descriptive Name and Mnemonic	12
Figure 2.4: Example of Instruction Format	12
Figure 2.5: Example of Instruction Purpose	13
Figure 2.6: Example of Instruction Description	13
Figure 2.7: Example of Instruction Restrictions	14
Figure 2.8: Example of Instruction Operation	15
Figure 2.9: Example of Instruction Exception	15
Figure 2.10: Example of Instruction Programming Notes	16
Figure 2.11: COP_LW Pseudocode Function	16
Figure 2.12: COP_LD Pseudocode Function	17
Figure 2.13: COP_SW Pseudocode Function	17
Figure 2.14: COP_SD Pseudocode Function	17
Figure 2.15: CoprocessorOperation Pseudocode Function	18
Figure 2.16: MisalignedSupport Pseudocode Function	18
Figure 2.17: AddressTranslation Pseudocode Function	19
Figure 2.18: LoadMemory Pseudocode Function	19
Figure 2.19: StoreMemory Pseudocode Function	20
Figure 2.20: Prefetch Pseudocode Function	20
Figure 2.21: SyncOperation Pseudocode Function	21
Figure 2.22: ValueFPR Pseudocode Function	21
Figure 2.23: StoreFPR Pseudocode Function	22
Figure 2.24: CheckFPEXception Pseudocode Function	23
Figure 2.25: FPConditionCode Pseudocode Function	23
Figure 2.26: SetFPConditionCode Pseudocode Function	24
Figure 2.27: sign_extend Pseudocode Functions	24
Figure 2.28: memory_address Pseudocode Function	25
Figure 2.29: Instruction Fetch Implicit memory_address Wrapping	25
Figure 2.30: AddressTranslation implicit memory_address Wrapping	25
Figure 2.31: SignalException Pseudocode Function	26
Figure 2.32: SignalDebugBreakpointException Pseudocode Function	26
Figure 2.33: SignalDebugModeBreakpointException Pseudocode Function	26
Figure 2.34: NullifyCurrentInstruction PseudoCode Function	26
Figure 2.35: PolyMult Pseudocode Function	27
Figure 3.1: ALIGN operation (32-bit)	39
Figure 3.2: Example of an ALNV.PS Operation	41
Figure 3.3: Usage of Address Fields to Select Index and Way	113
Figure 3.4: Usage of Address Fields to Select Index and Way	119
Figure 3.5: Operation of the EXT Instruction	173
Figure 3.6: Operation of the INS Instruction	177
Figure 4.1: Unaligned Word Load Using LWL and LWR	225
Figure 4.2: Bytes Loaded by LWL Instruction	226
Figure 4.3: Unaligned Word Load Using LWLE and LWRE	227
Figure 4.4: Bytes Loaded by LWLE Instruction	228
Figure 4.5: Unaligned Word Load Using LWL and LWR	231
Figure 4.6: Bytes Loaded by LWR Instruction	232

Figure 4.7: Unaligned Word Load Using LWLE and LWRE	234
Figure 4.8: Bytes Loaded by LWRE Instruction	235
Figure 5.9: Unaligned Word Store Using SWL and SWR	374
Figure 5.10: Bytes Stored by an SWL Instruction	375
Figure 5.11: Unaligned Word Store Using SWLE and SWRE	377
Figure 5.12: Bytes Stored by an SWLE Instruction.....	378
Figure 5.13: Unaligned Word Store Using SWR and SWL	379
Figure 5.14: Bytes Stored by SWR Instruction	380
Figure 5.15: Unaligned Word Store Using SWRE and SWLE	382
Figure 5.16: Bytes Stored by SWRE Instruction	383
Figure A.1: Sample Bit Encoding Table	427

List of Tables

Table 1.1: Symbols Used in Instruction Operation Statements.....	4
Table 1.2: Read/Write Register Field Notation	7
Table 2.1: AccessLength Specifications for Loads/Stores	20
Table 3.1: FPU Comparisons Without Special Operand Exceptions	109
Table 3.2: FPU Comparisons With Special Operand Exceptions for QNaNs	110
Table 3.3: Usage of Effective Address.....	112
Table 3.4: Encoding of Bits[17:16] of CACHE Instruction.....	113
Table 3.5: Encoding of Bits [20:18] of the CACHE Instruction	114
Table 3.6: Usage of Effective Address.....	119
Table 3.7: Encoding of Bits[17:16] of CACHEE Instruction	120
Table 3.8: Encoding of Bits [20:18] of the CACHEE Instruction	121
Table 4.1: Special Cases for FP MAX, MIN, MAXA, MINA.....	247
Table 5.2: Values of <i>hint</i> Field for PREF Instruction	303
Table 5.3: Values of <i>hint</i> Field for PREFE Instruction.....	307
Table 5.4: RDHWR Register Numbers	313
Table 5.5: Encodings of the Bits[10:6] of the SYNC instruction; the SType Field.....	387
Table A.1: Symbols Used in the Instruction Encoding Tables	427
Table A.2: MIPS32 Encoding of the Opcode Field	429
Table A.3: MIPS32 SPECIAL Opcode Encoding of Function Field	430
Table A.4: MIPS32 <i>REGIMM</i> Encoding of <i>rt</i> Field	430
Table A.5: MIPS32 SPECIAL2 Encoding of Function Field	431
Table A.6: MIPS32 <i>SPECIAL3</i> Encoding of Function Field for Release 2 of the Architecture.....	431
Table A.7: MIPS32 <i>MOVC6R</i> Encoding of <i>tf</i> Bit	431
Table A.8: MIPS32 <i>SRL</i> Encoding of Shift/Rotate	432
Table A.9: MIPS32 <i>SRLV</i> Encoding of Shift/Rotate.....	432
Table A.10: MIPS32 <i>BSHFL</i> Encoding of <i>sa</i> Field.....	432
Table A.11: MIPS32 <i>COP0</i> Encoding of <i>rs</i> Field	433
Table A.12: MIPS32 <i>COP0</i> Encoding of Function Field When <i>rs=CO</i>	433
Table A.13: PCREL Encoding of Minor Opcode Field	433
Table A.14: MIPS32 Encoding of <i>rs</i> Field	434
Table A.15: MIPS32 <i>COP1</i> Encoding of Function Field When <i>rs=S</i>	434
Table A.16: MIPS32 <i>COP1</i> Encoding of Function Field When <i>rs=D</i>	435
Table A.17: MIPS32 <i>COP1</i> Encoding of Function Field When <i>rs=W</i> or <i>L</i>	435
Table A.18: MIPS32 <i>COP1</i> Encoding of Function Field When <i>rs=PS</i>	436
Table A.19: MIPS32 <i>COP1</i> Encoding of <i>tf</i> Bit When <i>rs=S, D, or PS6R, Function=MOVCF6R</i>	436
Table A.20: MIPS32 <i>COP2</i> Encoding of <i>rs</i> Field	436
Table A.21: MIPS32 <i>COP1X6R</i> Encoding of Function Field	437
Table A.22: Floating Point Unit Instruction Format Encodings.....	437
Table A.23: Release 6 MUL/DIV encodings	440
Table A.24: Release 6 PC-relative family encoding.....	440
Table A.25: Release 6 PC-relative family encoding bitstrings	441
Table A.26: B*C compact branch encodings	442

About This Book

The MIPS32® Instruction Set Manual comes as part of a multi-volume set.

- Volume I-A describes conventions used throughout the document set, and provides an introduction to the MIPS32® Architecture
- Volume I-B describes conventions used throughout the document set, and provides an introduction to the microMIPS™ Architecture
- Volume II-A provides detailed descriptions of each instruction in the MIPS32® instruction set
- Volume II-B provides detailed descriptions of each instruction in the microMIPS32™ instruction set
- Volume III describes the MIPS32® and microMIPS32™ Privileged Resource Architecture which defines and governs the behavior of the privileged resources included in a MIPS® processor implementation
- Volume IV-a describes the MIPS16e™ Application-Specific Extension to the MIPS32® Architecture. Beginning with Release 3 of the Architecture, microMIPS is the preferred solution for smaller code size. Release 6 removes MIPS16e: MIPS16e cannot be implemented with Release 6.
- Volume IV-b describes the MDMX™ Application-Specific Extension to the MIPS64® Architecture and microMIPS64™. It is not applicable to the MIPS32® document set nor the microMIPS32™ document set. With Release 5 of the Architecture, MDMX is deprecated. MDMX and MSA can not be implemented at the same time. Release 6 removes MDMX: MDMX cannot be implemented with Release 6.
- Volume IV-c describes the MIPS-3D® Application-Specific Extension to the MIPS® Architecture. Release 6 removes MIPS-3D: MIPS-3D cannot be implemented with Release 6.
- Volume IV-d describes the SmartMIPS® Application-Specific Extension to the MIPS32® Architecture and the microMIPS32™ Architecture. Release 6 removes SmartMIPS: SmartMIPS cannot be implemented with Release 6, neither MIPS32 Release 6 nor MIPS64 Release 6.
- Volume IV-e describes the MIPS® DSP Module to the MIPS® Architecture.
- Volume IV-f describes the MIPS® MT Module to the MIPS® Architecture
- Volume IV-h describes the MIPS® MCU Application-Specific Extension to the MIPS® Architecture
- Volume IV-i describes the MIPS® Virtualization Module to the MIPS® Architecture
- Volume IV-j describes the MIPS® SIMD Architecture Module to the MIPS® Architecture

1.1 Typographical Conventions

This section describes the use of *italic*, **bold** and `courier` fonts in this book.

1.1.1 Italic Text

- is used for *emphasis*
- is used for *bits*, *fields*, and *registers* that are important from a software perspective (for instance, address bits used by software, and programmable fields and registers), and various *floating point instruction formats*, such as *S* and *D*
- is used for the memory access types, such as *cached* and *uncached*

1.1.2 Bold Text

- represents a term that is being **defined**
- is used for **bits** and **fields** that are important from a hardware perspective (for instance, **register** bits, which are not programmable but accessible only to hardware)
- is used for ranges of numbers; the range is indicated by an ellipsis. For instance, **5..1** indicates numbers 5 through 1
- is used to emphasize **UNPREDICTABLE** and **UNDEFINED** behavior, as defined below.

1.1.3 Courier Text

`Courier` fixed-width font is used for text that is displayed on the screen, and for examples of code and instruction pseudocode.

1.2 UNPREDICTABLE and UNDEFINED

The terms **UNPREDICTABLE** and **UNDEFINED** are used throughout this book to describe the behavior of the processor in certain cases. **UNDEFINED** behavior or operations can occur only as the result of executing instructions in a privileged mode (i.e., in Kernel Mode or Debug Mode, or with the CP0 usable bit set in the Status register). Unprivileged software can never cause **UNDEFINED** behavior or operations. Conversely, both privileged and unprivileged software can cause **UNPREDICTABLE** results or operations.

1.2.1 UNPREDICTABLE

UNPREDICTABLE results may vary from processor implementation to implementation, instruction to instruction, or as a function of time on the same implementation or instruction. Software can never depend on results that are **UNPREDICTABLE**. **UNPREDICTABLE** operations may cause a result to be generated or not. If a result is generated, it is **UNPREDICTABLE**. **UNPREDICTABLE** operations may cause arbitrary exceptions.

UNPREDICTABLE results or operations have several implementation restrictions:

- Implementations of operations generating **UNPREDICTABLE** results must not depend on any data source (memory or internal state) which is inaccessible in the current processor mode

- **UNPREDICTABLE** operations must not read, write, or modify the contents of memory or internal state which is inaccessible in the current processor mode. For example, **UNPREDICTABLE** operations executed in user mode must not access memory or internal state that is only accessible in Kernel Mode or Debug Mode or in another process
- **UNPREDICTABLE** operations must not halt or hang the processor

1.2.2 UNDEFINED

UNDEFINED operations or behavior may vary from processor implementation to implementation, instruction to instruction, or as a function of time on the same implementation or instruction. **UNDEFINED** operations or behavior may vary from nothing to creating an environment in which execution can no longer continue. **UNDEFINED** operations or behavior may cause data loss.

UNDEFINED operations or behavior has one implementation restriction:

- **UNDEFINED** operations or behavior must not cause the processor to hang (that is, enter a state from which there is no exit other than powering down the processor). The assertion of any of the reset signals must restore the processor to an operational state

1.2.3 UNSTABLE

UNSTABLE results or values may vary as a function of time on the same implementation or instruction. Unlike **UNPREDICTABLE** values, software may depend on the fact that a sampling of an **UNSTABLE** value results in a legal transient value that was correct at some point in time prior to the sampling.

UNSTABLE values have one implementation restriction:

- Implementations of operations generating **UNSTABLE** results must not depend on any data source (memory or internal state) which is inaccessible in the current processor mode

1.3 Special Symbols in Pseudocode Notation

In this book, algorithmic descriptions of an operation are described using a high-level language pseudocode resembling Pascal. Special symbols used in the pseudocode notation are listed in Table 1.1.

Table 1.1 Symbols Used in Instruction Operation Statements

Symbol	Meaning
\leftarrow	Assignment
$=, \neq$	Tests for equality and inequality
\parallel	Bit string concatenation
x^y	A y -bit string formed by y copies of the single-bit value x
$b\#n$	A constant value n in base b . For instance $10\#100$ represents the decimal value 100, $2\#100$ represents the binary value 100 (decimal 4), and $16\#100$ represents the hexadecimal value 100 (decimal 256). If the "b#" prefix is omitted, the default base is 10.
$0bn$	A constant value n in base 2. For instance $0b100$ represents the binary value 100 (decimal 4).
$0xn$	A constant value n in base 16. For instance $0x100$ represents the hexadecimal value 100 (decimal 256).

Table 1.1 Symbols Used in Instruction Operation Statements (Continued)

Symbol	Meaning
$x_{y..z}$	Selection of bits y through z of bit string x . Little-endian bit notation (rightmost bit is 0) is used. If y is less than z , this expression is an empty (zero length) bit string.
$x.bit[y]$	Bit y of bitstring x . Alternative to the traditional MIPS notation x_y .
$x.bits[y..z]$	Selection of bits y through z of bit string x . Alternative to the traditional MIPS notation $x_{y..z}$.
$x.byte[y]$	Byte y of bitstring x . Equivalent to the traditional MIPS notation $x_{8*y+7..8*y}$.
$x.bytes[y..z]$	Selection of bytes y through z of bit string x . Alternative to the traditional MIPS notation $x_{8*y+7..8*z}$.
$x.halfword[y]$ $x.word[i]$ $x.doubleword[i]$	Similar extraction of particular bitfields (used in e.g., MSA packed SIMD vectors).
$x.bit31$, $x.byte0$, etc.	Examples of abbreviated form of $x.bit[y]$, etc. notation, when y is a constant.
$x.fieldy$	Selection of a named subfield of bitstring x , typically a register or instruction encoding. More formally described as “Field y of register x ”. For example, $FIR.D$ = “the D bit of the Coprocessor 1 Floating-point Implementation Register (FIR)”.
$+$, $-$	2’s complement or floating point arithmetic: addition, subtraction
$*$, \times	2’s complement or floating point multiplication (both used for either)
div	2’s complement integer division
mod	2’s complement modulo
$/$	Floating point division
$<$	2’s complement less-than comparison
$>$	2’s complement greater-than comparison
\leq	2’s complement less-than or equal comparison
\geq	2’s complement greater-than or equal comparison
nor	Bitwise logical NOR
xor	Bitwise logical XOR
and	Bitwise logical AND
or	Bitwise logical OR
not	Bitwise inversion
$\&\&$	Logical (non-Bitwise) AND
\ll	Logical Shift left (shift in zeros at right-hand-side)
\gg	Logical Shift right (shift in zeros at left-hand-side)
$GPRLEN$	The length in bits (32 or 64) of the CPU general-purpose registers
$GPR[x]$	CPU general-purpose register x . The content of $GPR[0]$ is always zero. In Release 2 of the Architecture, $GPR[x]$ is a short-hand notation for $SGPR[SRSCtl_{CSS}, x]$.
$SGPR[s,x]$	In Release 2 of the Architecture and subsequent releases, multiple copies of the CPU general-purpose registers may be implemented. $SGPR[s,x]$ refers to GPR set s , register x .
$FPR[x]$	Floating Point operand register x
$FCC[CC]$	Floating Point condition code CC . $FCC[0]$ has the same value as $COC[1]$. Release 6 removes the floating point condition codes.
$FPR[x]$	Floating Point (Coprocessor unit 1), general register x

Table 1.1 Symbols Used in Instruction Operation Statements (Continued)

Symbol	Meaning
$CPR[z,x,s]$	Coprocessor unit z , general register x , select s
CP2CPR[x]	Coprocessor unit 2, general register x
$CCR[z,x]$	Coprocessor unit z , control register x
CP2CCR[x]	Coprocessor unit 2, control register x
$COC[z]$	Coprocessor unit z condition signal
$Xlat[x]$	Translation of the MIPS16e GPR number x into the corresponding 32-bit GPR number
BigEndianMem	Endian mode as configured at chip reset (0 → Little-Endian, 1 → Big-Endian). Specifies the endianness of the memory interface (see LoadMemory and StoreMemory pseudocode function descriptions) and the endianness of Kernel and Supervisor mode execution.
BigEndianCPU	The endianness for load and store instructions (0 → Little-Endian, 1 → Big-Endian). In User mode, this endianness may be switched by setting the <i>RE</i> bit in the <i>Status</i> register. Thus, BigEndianCPU may be computed as (BigEndianMem XOR ReverseEndian).
ReverseEndian	Signal to reverse the endianness of load and store instructions. This feature is available in User mode only, and is implemented by setting the <i>RE</i> bit of the <i>Status</i> register. Thus, ReverseEndian may be computed as (SR _{RE} and User mode).
<i>LLbit</i>	Bit of virtual state used to specify operation for instructions that provide atomic read-modify-write. <i>LLbit</i> is set when a linked load occurs and is tested by the conditional store. It is cleared, during other CPU operation, when a store to the location would no longer be atomic. In particular, it is cleared by exception return instructions.
I , I+n , I-n :	This occurs as a prefix to <i>Operation</i> description lines and functions as a label. It indicates the instruction time during which the pseudocode appears to “execute.” Unless otherwise indicated, all effects of the current instruction appear to occur during the instruction time of the current instruction. No label is equivalent to a time label of I . Sometimes effects of an instruction appear to occur either earlier or later — that is, during the instruction time of another instruction. When this happens, the instruction operation is written in sections labeled with the instruction time, relative to the current instruction I , in which the effect of that pseudocode appears to occur. For example, an instruction may have a result that is not available until after the next instruction. Such an instruction has the portion of the instruction operation description that writes the result register in a section labeled I+1 . The effect of pseudocode statements for the current instruction labeled I+1 appears to occur “at the same time” as the effect of pseudocode statements labeled I for the following instruction. Within one pseudocode sequence, the effects of the statements take place in order. However, between sequences of statements for different instructions that occur “at the same time,” there is no defined order. Programs must not depend on a particular order of evaluation between such sections.
PC	The <i>Program Counter</i> value. During the instruction time of an instruction, this is the address of the instruction word. The address of the instruction that occurs during the next instruction time is determined by assigning a value to <i>PC</i> during an instruction time. If no value is assigned to <i>PC</i> during an instruction time by any pseudocode statement, it is automatically incremented by either 2 (in the case of a 16-bit MIPS16e instruction) or 4 before the next instruction time. A taken branch assigns the target address to the <i>PC</i> during the instruction time of the instruction in the branch delay slot. In the MIPS Architecture, the <i>PC</i> value is only visible indirectly, such as when the processor stores the restart address into a GPR on a jump-and-link or branch-and-link instruction, or into a Coprocessor 0 register on an exception. Release 6 adds <i>PC</i> -relative address computation and load instructions. The <i>PC</i> value contains a full 32-bit address, all of which are significant during a memory reference.

Table 1.1 Symbols Used in Instruction Operation Statements (Continued)

Symbol	Meaning						
ISA Mode	<p>In processors that implement the MIPS16e Application Specific Extension or the microMIPS base architectures, the <i>ISA Mode</i> is a single-bit register that determines in which mode the processor is executing, as follows:</p> <table border="1" style="margin-left: auto; margin-right: auto;"> <thead> <tr> <th>Encoding</th> <th>Meaning</th> </tr> </thead> <tbody> <tr> <td>0</td> <td>The processor is executing 32-bit MIPS instructions</td> </tr> <tr> <td>1</td> <td>The processor is executing MIIPS16e or microMIPS instructions</td> </tr> </tbody> </table> <p>In the MIPS Architecture, the <i>ISA Mode</i> value is only visible indirectly, such as when the processor stores a combined value of the upper bits of PC and the <i>ISA Mode</i> into a GPR on a jump-and-link or branch-and-link instruction, or into a Coprocessor 0 register on an exception.</p>	Encoding	Meaning	0	The processor is executing 32-bit MIPS instructions	1	The processor is executing MIIPS16e or microMIPS instructions
Encoding	Meaning						
0	The processor is executing 32-bit MIPS instructions						
1	The processor is executing MIIPS16e or microMIPS instructions						
PABITS	The number of physical address bits implemented is represented by the symbol PABITS. As such, if 36 physical address bits were implemented, the size of the physical address space would be $2^{PABITS} = 2^{36}$ bytes.						
FP32RegistersMode	<p>Indicates whether the FPU has 32-bit or 64-bit floating point registers (FPRs). In MIPS32 Release 1, the FPU has 32, 32-bit FPRs, in which 64-bit data types are stored in even-odd pairs of FPRs. In MIPS64, (and optionally in MIPS32 Release2 and Release 3) the FPU has 32 64-bit FPRs in which 64-bit data types are stored in any FPR.</p> <p>In MIPS32 Release 1 implementations, FP32RegistersMode is always a 0. MIPS64 implementations have a compatibility mode in which the processor references the FPRs as if it were a MIPS32 implementation. In such a case FP32RegistersMode is computed from the FR bit in the <i>Status</i> register. If this bit is a 0, the processor operates as if it had 32, 32-bit FPRs. If this bit is a 1, the processor operates with 32 64-bit FPRs.</p> <p>The value of FP32RegistersMode is computed from the FR bit in the <i>Status</i> register.</p>						
InstructionInBranchDelaySlot	Indicates whether the instruction at the Program Counter address was executed in the delay slot of a branch or jump. This condition reflects the <i>dynamic</i> state of the instruction, not the <i>static</i> state. That is, the value is false if a branch or jump occurs to an instruction whose PC immediately follows a branch or jump, but which is not executed in the delay slot of a branch or jump.						
SignalException(exception, argument)	Causes an exception to be signaled, using the exception parameter as the type of exception and the argument parameter as an exception-specific argument). Control does not return from this pseudocode function—the exception is signaled at the point of the call.						

1.4 Notation for Register Field Accessibility

In this document, the read/write properties of register fields use the notations shown in Table 1.1.

Table 1.2 Read/Write Register Field Notation

Read/Write Notation	Hardware Interpretation	Software Interpretation
R/W	<p>A field in which all bits are readable and writable by software and, potentially, by hardware. Hardware updates of this field are visible by software read. Software updates of this field are visible by hardware read.</p> <p>If the Reset State of this field is “Undefined”, either software or hardware must initialize the value before the first read will return a predictable value. This should not be confused with the formal definition of UNDEFINED behavior.</p>	

Table 1.2 Read/Write Register Field Notation (Continued)

Read/Write Notation	Hardware Interpretation	Software Interpretation
R	<p>A field which is either static or is updated only by hardware.</p> <p>If the Reset State of this field is either “0”, “Preset”, or “Externally Set”, hardware initializes this field to zero or to the appropriate state, respectively, on powerup. The term “Preset” is used to suggest that the processor establishes the appropriate state, whereas the term “Externally Set” is used to suggest that the state is established via an external source (e.g., personality pins or initialization bit stream). These terms are suggestions only, and are not intended to act as a requirement on the implementation.</p> <p>If the Reset State of this field is “Undefined”, hardware updates this field only under those conditions specified in the description of the field.</p>	<p>A field to which the value written by software is ignored by hardware. Software may write any value to this field without affecting hardware behavior. Software reads of this field return the last value updated by hardware.</p> <p>If the Reset State of this field is “Undefined”, software reads of this field result in an UNPREDICTABLE value except after a hardware update done under the conditions specified in the description of the field.</p>
R0	<p>R0 = reserved, read as zero, ignore writes by software.</p> <p>Hardware ignores software writes to an R0 field. Neither the occurrence of such writes, nor the values written, affects hardware behavior.</p> <p>Hardware always returns 0 to software reads of R0 fields.</p> <p>The Reset State of an R0 field must always be 0.</p> <p>If software performs an mtc0 instruction which writes a non-zero value to an R0 field, the write to the R0 field will be ignored, but permitted writes to other fields in the register will not be affected.</p>	<p>Architectural Compatibility: R0 fields are reserved, and may be used for not-yet-defined purposes in future revisions of the architecture.</p> <p>When writing an R0 field, current software should only write either all 0s, or, preferably, write back the same value that was read from the field.</p> <p>Current software should not assume that the value read from R0 fields is zero, because this may not be true on future hardware.</p> <p>Future revisions of the architecture may redefine an R0 field, but must do so in such a way that software which is unaware of the new definition and either writes zeros or writes back the value it has read from the field will continue to work correctly.</p> <p>Writing back the same value that was read is guaranteed to have no unexpected effects on current or future hardware behavior. (Except for non-atomicity of such read-writes.)</p> <p>Writing zeros to an R0 field may not be preferred because in the future this may interfere with the operation of other software which has been updated for the new field definition.</p>

Table 1.2 Read/Write Register Field Notation (Continued)

Read/Write Notation	Hardware Interpretation	Software Interpretation	
0	Release 6		
	<p>Release 6 legacy “0” behaves like R0 - read as zero, nonzero writes ignored. Legacy “0” should not be defined for any new control register fields; R0 should be used instead.</p> <table border="0" style="width: 100%;"> <tr> <td style="width: 50%; vertical-align: top;"> <p>HW returns 0 when read. HW ignores writes.</p> </td> <td style="width: 50%; vertical-align: top;"> <p>Only zero should be written, or, value read from register.</p> </td> </tr> </table>		<p>HW returns 0 when read. HW ignores writes.</p>
<p>HW returns 0 when read. HW ignores writes.</p>	<p>Only zero should be written, or, value read from register.</p>		
	pre-Release 6		
	pre-Release 6 legacy “0” - read as zero, nonzero writes UNDEFINED		
	<p>A field which hardware does not update, and for which hardware can assume a zero value.</p>	<p>A field to which the value written by software must be zero. Software writes of non-zero values to this field may result in UNDEFINED behavior of the hardware. Software reads of this field return zero as long as all previous software writes are zero. If the Reset State of this field is “Undefined”, software must write this field with zero before it is guaranteed to read as zero.</p>	
R/W0	Like R/W, except that writes of non-zero to a R/W0 field are ignored. E.g. Status.NMI		
	<p>Hardware may set or clear an R/W0 bit.</p> <p>Hardware ignores software writes of nonzero to an R/W0 field. Neither the occurrence of such writes, nor the values written, affects hardware behavior.</p> <p>Software writes of 0 to an R/W0 field may have an effect.</p> <p>Hardware may return 0 or nonzero to software reads of an R/W0 bit.</p> <p>If software performs an mtc0 instruction which writes a non-zero value to an R/W0 field, the write to the R/W0 field will be ignored, but permitted writes to other fields in the register will not be affected.</p>	<p>Software can only clear an R/W0 bit.</p> <p>Software writes 0 to an R/W0 field to clear the field.</p> <p>Software writes nonzero to an R/W0 bit in order to guarantee that the bit is not affected by the write.</p>	

1.5 For More Information

MIPS processor manuals and additional information about MIPS products can be found at <http://www.oru.com>.

0

Guide to the Instruction Set

This chapter provides a detailed guide to understanding the instruction descriptions, which are listed in alphabetical order in the tables at the beginning of the next chapter.

2.1 Understanding the Instruction Fields

Figure 2.1 shows an example instruction. Following the figure are descriptions of the fields listed below:

- “Instruction Fields” on page 12
- “Instruction Descriptive Name and Mnemonic” on page 12
- “Format Field” on page 12
- “Purpose Field” on page 13
- “Description Field” on page 13
- “Restrictions Field” on page 13
- “Operation Field” on page 15
- “Exceptions Field” on page 15
- “Programming Notes and Implementation Notes Fields” on page 15

Figure 2.1 Example of Instruction Description

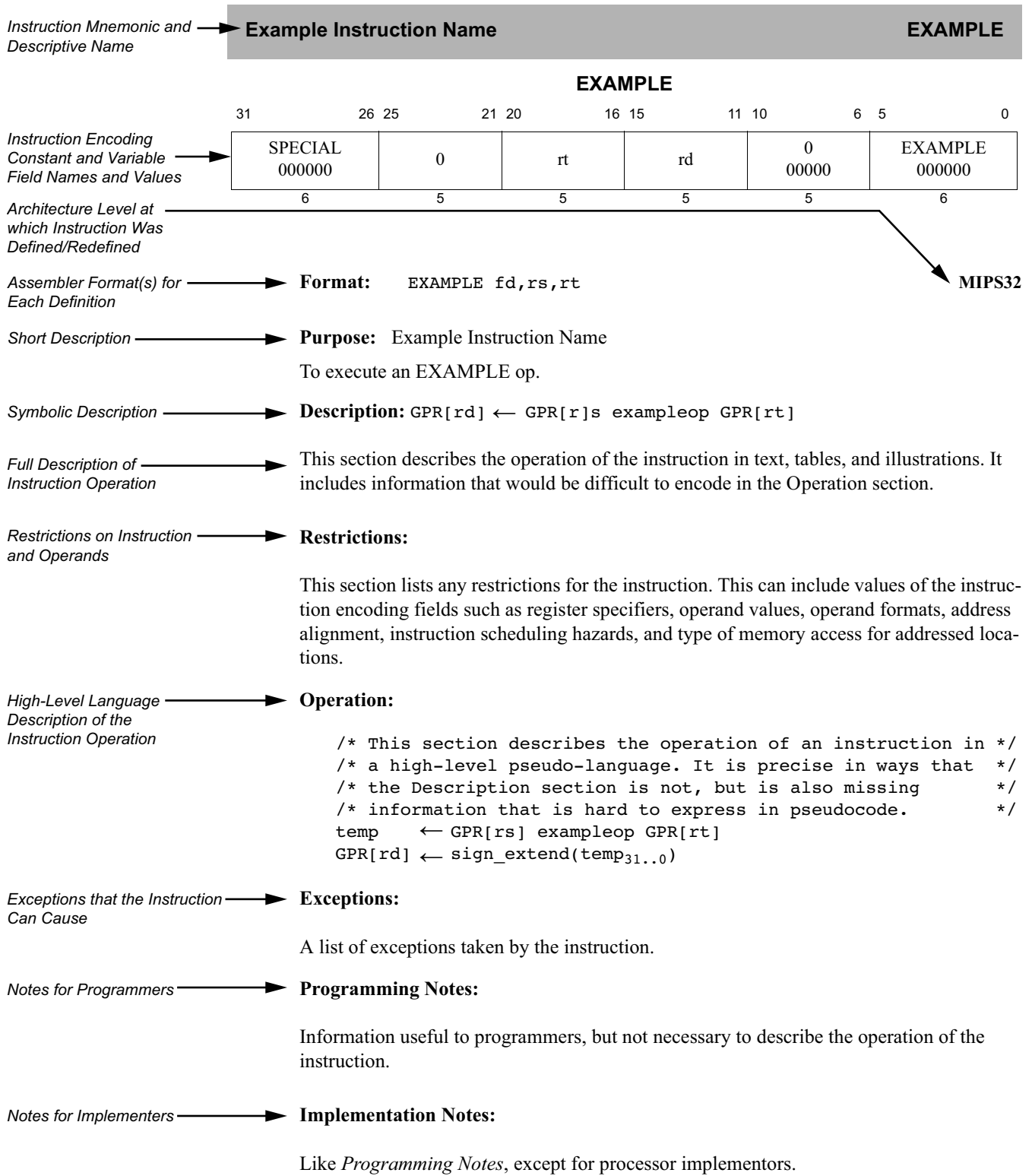

2.1.1 Instruction Fields

Fields encoding the instruction word are shown in register form at the top of the instruction description. The following rules are followed:

- The values of constant fields and the *opcode* names are listed in uppercase (SPECIAL and ADD in Figure 2.2). Constant values in a field are shown in binary below the symbolic or hexadecimal value.
- All variable fields are listed with the lowercase names used in the instruction description (*rs*, *rt*, and *rd* in Figure 2.2).
- Fields that contain zeros but are not named are unused fields that are required to be zero (bits 10:6 in Figure 2.2). If such fields are set to non-zero values, the operation of the processor is **UNPREDICTABLE**.

Figure 2.2 Example of Instruction Fields

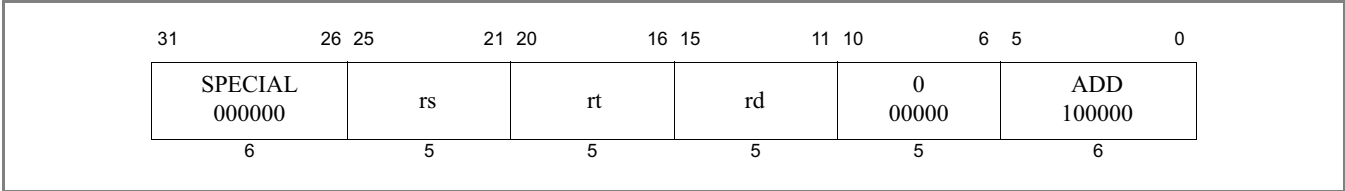

2.1.2 Instruction Descriptive Name and Mnemonic

The instruction descriptive name and mnemonic are printed as page headings for each instruction, as shown in Figure 2.3.

Figure 2.3 Example of Instruction Descriptive Name and Mnemonic



2.1.3 Format Field

The assembler formats for the instruction and the architecture level at which the instruction was originally defined are given in the *Format* field. If the instruction definition was later extended, the architecture levels at which it was extended and the assembler formats for the extended definition are shown in their order of extension (for an example, see C.cond.fmt). The MIPS architecture levels are inclusive; higher architecture levels include all instructions in previous levels. Extensions to instructions are backwards compatible. The original assembler formats are valid for the extended architecture.

Figure 2.4 Example of Instruction Format



The assembler format is shown with literal parts of the assembler instruction printed in uppercase characters. The variable parts, the operands, are shown as the lowercase names of the appropriate fields.

The architectural level at which the instruction was first defined, for example “MIPS32” is shown at the right side of the page. Instructions introduced at different times by different ISA family members, are indicated by markings such

as “MIPS64, MIPS32 Release 2”. Instructions removed by particular architecture release are indicated in the Availability section.

There can be more than one assembler format for each architecture level. Floating point operations on formatted data show an assembly format with the actual assembler mnemonic for each valid value of the *fmt* field. For example, the ADD.*fmt* instruction lists both ADD.S and ADD.D.

The assembler format lines sometimes include parenthetical comments to help explain variations in the formats (once again, see C.cond.*fmt*). These comments are not a part of the assembler format.

2.1.4 Purpose Field

The *Purpose* field gives a short description of the use of the instruction.

Figure 2.5 Example of Instruction Purpose

Purpose: Add Word

To add 32-bit integers. If an overflow occurs, then trap.

2.1.5 Description Field

If a one-line symbolic description of the instruction is feasible, it appears immediately to the right of the *Description* heading. The main purpose is to show how fields in the instruction are used in the arithmetic or logical operation.

Figure 2.6 Example of Instruction Description

Description: $GPR[rd] \leftarrow GPR[rs] + GPR[rt]$

The 32-bit word value in GPR *rt* is added to the 32-bit value in GPR *rs* to produce a 32-bit result.

- If the addition results in 32-bit 2’s complement arithmetic overflow, the destination register is not modified and an Integer Overflow exception occurs.
- If the addition does not overflow, the 32-bit result is placed into GPR *rd*.

The body of the section is a description of the operation of the instruction in text, tables, and figures. This description complements the high-level language description in the *Operation* section.

This section uses acronyms for register descriptions. “GPR *rt*” is CPU general-purpose register specified by the instruction field *rt*. “FPR *fs*” is the floating point operand register specified by the instruction field *fs*. “CP1 register *fd*” is the coprocessor 1 general register specified by the instruction field *fd*. “FCSR” is the floating point *Control / Status* register.

2.1.6 Restrictions Field

The *Restrictions* field documents any possible restrictions that may affect the instruction. Most restrictions fall into one of the following six categories:

- Valid values for instruction fields (for example, see floating point ADD.*fmt*)

- ALIGNMENT requirements for memory addresses (for example, see LW)
- Valid values of operands (for example, see ALNV.PS)
- Valid operand formats (for example, see floating point ADD.fmt)
- Order of instructions necessary to guarantee correct execution. These ordering constraints avoid pipeline hazards for which some processors do not have hardware interlocks (for example, see MUL).
- Valid memory access types (for example, see LL/SC)

Figure 2.7 Example of Instruction Restrictions

<p>Restrictions: None</p>

2.1.7 Availability and Compatibility Fields

The *Availability* and *Compatibility* sections are not provided for all instructions. These sections list considerations relevant to whether and how an implementation may implement some instructions, when software may use such instructions, and how software can determine if an instruction or feature is present. Such considerations include:

- Some instructions are not present on all architecture releases. Sometimes the implementation is required to signal a Reserved Instruction exception, but sometimes executing such an instruction encoding is architecturally defined to give UNPREDICTABLE results.
- Some instructions are available for implementations of a particular architecture release, but may be provided only if an optional feature is implemented. Control register bits typically allow software to determine if the feature is present.
- Some instructions may not behave the same way on all implementations. Typically this involves behavior that was UNPREDICTABLE in some implementations, but which is made architectural and guaranteed consistent so that software can rely on it in subsequent architecture releases.
- Some instructions are prohibited for certain architecture releases and/or optional feature combinations.
- Some instructions may be removed for certain architecture releases. Implementations may then be required to signal a Reserved Instruction exception for the removed instruction encoding; but sometimes the instruction encoding is reused for other instructions.

All of these considerations may apply to the same instruction. If such considerations applicable to an instruction are simple, the architecture level in which an instruction was defined or redefined in the *Format* field, and/or the *Restrictions* section, may be sufficient; but if the set of such considerations applicable to an instruction is complicated, the *Availability* and *Compatibility* sections may be provided.

2.1.8 Operation Field

The *Operation* field describes the operation of the instruction as pseudocode in a high-level language notation resembling Pascal. This formal description complements the *Description* section; it is not complete in itself because many of the restrictions are either difficult to include in the pseudocode or are omitted for legibility.

Figure 2.8 Example of Instruction Operation

Operation:

```
temp ← (GPR[rs]31 || GPR[rs]31..0) + (GPR[rt]31 || GPR[rt]31..0)
if temp32 ≠ temp31 then
    SignalException(IntegerOverflow)
else
    GPR[rd] ← temp
endif
```

See 2.2 “Operation Section Notation and Functions” on page 16 for more information on the formal notation used here.

2.1.9 Exceptions Field

The *Exceptions* field lists the exceptions that can be caused by *Operation* of the instruction. It omits exceptions that can be caused by the instruction fetch, for instance, TLB Refill, and also omits exceptions that can be caused by asynchronous external events such as an Interrupt. Although a Bus Error exception may be caused by the operation of a load or store instruction, this section does not list Bus Error for load and store instructions because the relationship between load and store instructions and external error indications, like Bus Error, are dependent upon the implementation.

Figure 2.9 Example of Instruction Exception

Exceptions:

Integer Overflow

An instruction may cause implementation-dependent exceptions that are not present in the *Exceptions* section.

2.1.10 Programming Notes and Implementation Notes Fields

The *Notes* sections contain material that is useful for programmers and implementors, respectively, but that is not necessary to describe the instruction and does not belong in the description sections.

Figure 2.10 Example of Instruction Programming Notes**Programming Notes:**

ADDU performs the same arithmetic operation but does not trap on overflow.

2.2 Operation Section Notation and Functions

In an instruction description, the *Operation* section uses a high-level language notation to describe the operation performed by each instruction. Special symbols used in the pseudocode are described in the previous chapter. Specific pseudocode functions are described below.

This section presents information about the following topics:

- “Instruction Execution Ordering” on page 16
- “Pseudocode Functions” on page 16

2.2.1 Instruction Execution Ordering

Each of the high-level language statements in the *Operations* section are executed sequentially (except as constrained by conditional and loop constructs).

2.2.2 Pseudocode Functions

There are several functions used in the pseudocode descriptions. These are used either to make the pseudocode more readable, to abstract implementation-specific behavior, or both. These functions are defined in this section, and include the following:

- “Coprocessor General Register Access Functions” on page 16
- “Memory Operation Functions” on page 18
- “Floating Point Functions” on page 21
- “Miscellaneous Functions” on page 25

2.2.2.1 Coprocessor General Register Access Functions

Defined coprocessors, except for CP0, have instructions to exchange words and doublewords between coprocessor general registers and the rest of the system. What a coprocessor does with a word or doubleword supplied to it and how a coprocessor supplies a word or doubleword is defined by the coprocessor itself. This behavior is abstracted into the functions described in this section.

2.2.2.1.1 COP_LW

The COP_LW function defines the action taken by coprocessor *z* when supplied with a word from memory during a load word operation. The action is coprocessor-specific. The typical action would be to store the contents of memword in coprocessor general register *rt*.

Figure 2.11 COP_LW Pseudocode Function

```
COP_LW (z, rt, memword)
```

```
z: The coprocessor unit number
rt: Coprocessor general register specifier
memword: A 32-bit word value supplied to the coprocessor

/* Coprocessor-dependent action */

endfunction COP_LW
```

2.2.2.1.2 COP_LD

The COP_LD function defines the action taken by coprocessor *z* when supplied with a doubleword from memory during a load doubleword operation. The action is coprocessor-specific. The typical action would be to store the contents of memdouble in coprocessor general register *rt*.

Figure 2.12 COP_LD Pseudocode Function

```
COP_LD (z, rt, memdouble)
z: The coprocessor unit number
rt: Coprocessor general register specifier
memdouble: 64-bit doubleword value supplied to the coprocessor.

/* Coprocessor-dependent action */

endfunction COP_LD
```

2.2.2.1.3 COP_SW

The COP_SW function defines the action taken by coprocessor *z* to supply a word of data during a store word operation. The action is coprocessor-specific. The typical action would be to supply the contents of the low-order word in coprocessor general register *rt*.

Figure 2.13 COP_SW Pseudocode Function

```
dataword ← COP_SW (z, rt)
z: The coprocessor unit number
rt: Coprocessor general register specifier
dataword: 32-bit word value

/* Coprocessor-dependent action */

endfunction COP_SW
```

2.2.2.1.4 COP_SD

The COP_SD function defines the action taken by coprocessor *z* to supply a doubleword of data during a store doubleword operation. The action is coprocessor-specific. The typical action would be to supply the contents of the low-order doubleword in coprocessor general register *rt*.

Figure 2.14 COP_SD Pseudocode Function

```
datadouble ← COP_SD (z, rt)
z: The coprocessor unit number
rt: Coprocessor general register specifier
datadouble: 64-bit doubleword value

/* Coprocessor-dependent action */
```

```
endfunction COP_SD
```

2.2.2.1.5 CoprocessorOperation

The CoprocessorOperation function performs the specified Coprocessor operation.

Figure 2.15 CoprocessorOperation Pseudocode Function

```
CoprocessorOperation (z, cop_fun)

/* z:          Coprocessor unit number */
/* cop_fun:    Coprocessor function from function field of instruction */

/* Transmit the cop_fun value to coprocessor z */

endfunction CoprocessorOperation
```

2.2.2.2 Memory Operation Functions

Regardless of byte ordering (big- or little-endian), the address of a halfword, word, or doubleword is the smallest byte address of the bytes that form the object. For big-endian ordering this is the most-significant byte; for a little-endian ordering this is the least-significant byte.

In the *Operation* pseudocode for load and store operations, the following functions summarize the handling of virtual addresses and the access of physical memory. The size of the data item to be loaded or stored is passed in the *AccessLength* field. The valid constant names and values are shown in Table 2.1. The bytes within the addressed unit of memory (word for 32-bit processors or doubleword for 64-bit processors) that are used can be determined directly from the *AccessLength* and the two or three low-order bits of the address.

2.2.2.2.1 Misaligned Support

MIPS processors originally required all memory accesses to be naturally aligned. MSA (the MIPS SIMD Architecture) supported misaligned memory accesses for its 128 bit packed SIMD vector loads and stores, from its introduction in MIPS Release 5. Release 6 requires systems to provide support for misaligned memory accesses for all ordinary memory reference instructions: the system must provide a mechanism to complete a misaligned memory reference for this instruction, ranging from full execution in hardware to trap-and-emulate.

The pseudocode function MisalignedSupport encapsulates the version number check to determine if misalignment is supported for an ordinary memory access.

Figure 2.16 MisalignedSupport Pseudocode Function

```
predicate ← MisalignedSupport ()
return Config.AR ≥ 2 // Architecture Revision 2 corresponds to MIPS Release 6.
end function
```

See Appendix B, “Misaligned Memory Accesses” on page 511 for a more detailed discussion of misalignment, including pseudocode functions for the actual misaligned memory access.

2.2.2.2.2 AddressTranslation

The AddressTranslation function translates a virtual address to a physical address and its cacheability and coherency attribute, describing the mechanism used to resolve the memory reference.

Given the virtual address $vAddr$, and whether the reference is to Instructions or Data ($IorD$), find the corresponding physical address ($pAddr$) and the cacheability and coherency attribute (CCA) used to resolve the reference. If the virtual address is in one of the unmapped address spaces, the physical address and CCA are determined directly by the virtual address. If the virtual address is in one of the mapped address spaces then the TLB or fixed mapping MMU determines the physical address and access type; if the required translation is not present in the TLB or the desired access is not permitted, the function fails and an exception is taken.

Figure 2.17 AddressTranslation Pseudocode Function

```
(pAddr, CCA) ← AddressTranslation (vAddr, IorD, LorS)

/* pAddr: physical address */
/* CCA: Cacheability&Coherency Attribute, the method used to access caches*/
/*      and memory and resolve the reference */

/* vAddr: virtual address */
/* IorD: Indicates whether access is for INSTRUCTION or DATA */
/* LorS: Indicates whether access is for LOAD or STORE */

/* See the address translation description for the appropriate MMU */
/* type in Volume III of this book for the exact translation mechanism */

endfunction AddressTranslation
```

2.2.2.2.3 LoadMemory

The LoadMemory function loads a value from memory.

This action uses cache and main memory as specified in both the Cacheability and Coherency Attribute (CCA) and the access ($IorD$) to find the contents of $AccessLength$ memory bytes, starting at physical location $pAddr$. The data is returned in a fixed-width naturally aligned memory element ($MemElem$). The low-order 2 (or 3) bits of the address and the $AccessLength$ indicate which of the bytes within $MemElem$ need to be passed to the processor. If the memory access type of the reference is *uncached*, only the referenced bytes are read from memory and marked as valid within the memory element. If the access type is *cached* but the data is not present in cache, an implementation-specific *size* and *alignment* block of memory is read and loaded into the cache to satisfy a load reference. At a minimum, this block is the entire memory element.

Figure 2.18 LoadMemory Pseudocode Function

```
MemElem ← LoadMemory (CCA, AccessLength, pAddr, vAddr, IorD)

/* MemElem: Data is returned in a fixed width with a natural alignment. The */
/*          width is the same size as the CPU general-purpose register, */
/*          32 or 64 bits, aligned on a 32- or 64-bit boundary, */
/*          respectively. */
/* CCA: Cacheability&CoherencyAttribute=method used to access caches */
/*      and memory and resolve the reference */

/* AccessLength: Length, in bytes, of access */
/* pAddr: physical address */
/* vAddr: virtual address */
/* IorD: Indicates whether access is for Instructions or Data */

endfunction LoadMemory
```

2.2.2.2.4 StoreMemory

The StoreMemory function stores a value to memory.

The specified data is stored into the physical location *pAddr* using the memory hierarchy (data caches and main memory) as specified by the Cacheability and Coherency Attribute (*CCA*). The *MemElem* contains the data for an aligned, fixed-width memory element (a word for 32-bit processors, a doubleword for 64-bit processors), though only the bytes that are actually stored to memory need be valid. The low-order two (or three) bits of *pAddr* and the *AccessLength* field indicate which of the bytes within the *MemElem* data should be stored; only these bytes in memory will actually be changed.

Figure 2.19 StoreMemory Pseudocode Function

```
StoreMemory (CCA, AccessLength, MemElem, pAddr, vAddr)

/* CCA:      Cacheability&Coherency Attribute, the method used to access */
/*          caches and memory and resolve the reference. */
/* AccessLength: Length, in bytes, of access */
/* MemElem:  Data in the width and alignment of a memory element. */
/*          The width is the same size as the CPU general */
/*          purpose register, either 4 or 8 bytes, */
/*          aligned on a 4- or 8-byte boundary. For a */
/*          partial-memory-element store, only the bytes that will be*/
/*          stored must be valid.*/
/* pAddr:    physical address */
/* vAddr:    virtual address */

endfunction StoreMemory
```

2.2.2.2.5 Prefetch

The Prefetch function prefetches data from memory.

Prefetch is an advisory instruction for which an implementation-specific action is taken. The action taken may increase performance but must not change the meaning of the program or alter architecturally visible state.

Figure 2.20 Prefetch Pseudocode Function

```
Prefetch (CCA, pAddr, vAddr, DATA, hint)

/* CCA:      Cacheability&Coherency Attribute, the method used to access */
/*          caches and memory and resolve the reference. */
/* pAddr:    physical address */
/* vAddr:    virtual address */
/* DATA:    Indicates that access is for DATA */
/* hint:     hint that indicates the possible use of the data */

endfunction Prefetch
```

Table 2.1 lists the data access lengths and their labels for loads and stores.

Table 2.1 AccessLength Specifications for Loads/Stores

AccessLength Name	Value	Meaning
DOUBLEWORD	7	8 bytes (64 bits)

Table 2.1 AccessLength Specifications for Loads/Stores

AccessLength Name	Value	Meaning
SEPTIBYTE	6	7 bytes (56 bits)
SEXTIBYTE	5	6 bytes (48 bits)
QUINTIBYTE	4	5 bytes (40 bits)
WORD	3	4 bytes (32 bits)
TRIPLEBYTE	2	3 bytes (24 bits)
HALFWORD	1	2 bytes (16 bits)
BYTE	0	1 byte (8 bits)

2.2.2.2.6 SyncOperation

The SyncOperation function orders loads and stores to synchronize shared memory.

This action makes the effects of the synchronizable loads and stores indicated by *stype* occur in the same order for all processors.

Figure 2.21 SyncOperation Pseudocode Function

```

SyncOperation(stype)

    /* stype: Type of load/store ordering to perform. */

    /* Perform implementation-dependent operation to complete the */
    /* required synchronization operation */

endfunction SyncOperation

```

2.2.2.3 Floating Point Functions

The pseudocode shown in below specifies how the unformatted contents loaded or moved to CP1 registers are interpreted to form a formatted value. If an FPR contains a value in some format, rather than unformatted contents from a load (uninterpreted), it is valid to interpret the value in that format (but not to interpret it in a different format).

2.2.2.3.1 ValueFPR

The ValueFPR function returns a formatted value from the floating point registers.

Figure 2.22 ValueFPR Pseudocode Function

```

value ← ValueFPR(fpr, fmt)

    /* value: The formattted value from the FPR */

    /* fpr:   The FPR number */
    /* fmt:   The format of the data, one of: */
    /*        S, D, W, L, PS, */
    /*        OB, QH, */
    /*        UNINTERPRETED_WORD, */
    /*        UNINTERPRETED_DOUBLEWORD */
    /* The UNINTERPRETED values are used to indicate that the datatype */
    /* is not known as, for example, in SWC1 and SDC1 */

```

```

case fmt of
  S, W, UNINTERPRETED_WORD:
    valueFPR ← FPR[fpr]

  D, UNINTERPRETED_DOUBLEWORD:
    if (FP32RegistersMode = 0)
      if (fpr0 ≠ 0) then
        valueFPR ← UNPREDICTABLE
      else
        valueFPR ← FPR[fpr+1]31..0 || FPR[fpr]31..0
      endif
    else
      valueFPR ← FPR[fpr]
    endif

  L:
    if (FP32RegistersMode = 0) then
      valueFPR ← UNPREDICTABLE
    else
      valueFPR ← FPR[fpr]
    endif

  DEFAULT:
    valueFPR ← UNPREDICTABLE

endcase
endfunction ValueFPR

```

The pseudocode shown below specifies the way a binary encoding representing a formatted value is stored into CPI registers by a computational or move operation. This binary representation is visible to store or move-from instructions. Once an FPR receives a value from the StoreFPR(), it is not valid to interpret the value with ValueFPR() in a different format.

2.2.2.3.2 StoreFPR

Figure 2.23 StoreFPR Pseudocode Function

```

StoreFPR (fpr, fmt, value)

/* fpr:   The FPR number */
/* fmt:   The format of the data, one of: */
/*        S, D, W, L, PS, */
/*        OB, QH, */
/*        UNINTERPRETED_WORD, */
/*        UNINTERPRETED_DOUBLEWORD */
/* value: The formatted value to be stored into the FPR */

/* The UNINTERPRETED values are used to indicate that the datatype */
/* is not known as, for example, in LWC1 and LDC1 */

case fmt of
  S, W, UNINTERPRETED_WORD:
    FPR[fpr] ← value

  D, UNINTERPRETED_DOUBLEWORD:

```



```

if (FP32RegistersMode = 0)
  if (fpr0 ≠ 0) then
    UNPREDICTABLE
  else
    FPR[fpr] ← UNPREDICTABLE32 || value31..0
    FPR[fpr+1] ← UNPREDICTABLE32 || value63..32
  endif
else
  FPR[fpr] ← value
endif

L:
if (FP32RegistersMode = 0) then
  UNPREDICTABLE
else
  FPR[fpr] ← value
endif

endcase

endfunction StoreFPR

```

2.2.2.3.3 CheckFPEException

The pseudocode shown below checks for an enabled floating point exception and conditionally signals the exception.

Figure 2.24 CheckFPEException Pseudocode Function

```

CheckFPEException()

/* A floating point exception is signaled if the E bit of the Cause field is a 1 */
/* (Unimplemented Operations have no enable) or if any bit in the Cause field */
/* and the corresponding bit in the Enable field are both 1 */

if ( (FCSR17 = 1) or
      ((FCSR16..12 and FCSR11..7) ≠ 0) ) then
  SignalException(FloatingPointException)
endif

endfunction CheckFPEException

```

2.2.2.3.4 FPConditionCode

The FPConditionCode function returns the value of a specific floating point condition code.

Figure 2.25 FPConditionCode Pseudocode Function

```

tf ← FPConditionCode(cc)

/* tf: The value of the specified condition code */

/* cc: The Condition code number in the range 0..7 */

if cc = 0 then
  FPConditionCode ← FCSR23
else
  FPConditionCode ← FCSR24+cc

```

```

endif

endfunction FPConditionCode

```

2.2.2.3.5 SetFPConditionCode

The SetFPConditionCode function writes a new value to a specific floating point condition code.

Figure 2.26 SetFPConditionCode Pseudocode Function

```

SetFPConditionCode(cc, tf)
  if cc = 0 then
    FCSR ← FCSR31..24 || tf || FCSR22..0
  else
    FCSR ← FCSR31..25+cc || tf || FCSR23+cc..0
  endif

endfunction SetFPConditionCode

```

2.2.2.4 Pseudocode Functions Related to Sign and Zero Extension

2.2.2.4.1 Sign extension and zero extension in pseudocode

Much pseudocode uses a generic function `sign_extend` without specifying from what bit position the extension is done, when the intention is obvious. E.g. `sign_extend(immediate16)` or `sign_extend(dispatch9)`.

However, sometimes it is necessary to specify the bit position. For example, `sign_extend(temp31..0)` or the more complicated `(offset15)GPRLEN-(16+2) || offset || 02`.

The explicit notation `sign_extend.nbits(val)` or `sign_extend(val, nbits)` is suggested as a simplification. They say to sign extend as if an `nbits`-sized signed integer. The width to be sign extended to is usually apparent by context, and is usually `GPRLEN`, 32 or 64 bits. The previous examples then become.

```

sign_extend(temp31..0)
= sign_extend.32(temp)

```

and

```

(offset15)GPRLEN-(16+2) || offset || 02
= sign_extend.16(offset) << 2

```

Note that `sign_extend.N(value)` extends from bit position `N-1`, if the bits are numbered `0..N-1` as is typical.

The explicit notations `sign_extend.nbits(val)` or `sign_extend(val, nbits)` is used as a simplification. These notations say to sign extend as if an `nbits`-sized signed integer. The width to be sign extended to is usually apparent by context, and is usually `GPRLEN`, 32 or 64 bits.

Figure 2.27 sign_extend Pseudocode Functions

```

sign_extend.nbits(val) = sign_extend(val, nbits) /* syntactic equivalents */

function sign_extend(val, nbits)
  return (valnbits-1)GPRLEN-nbits || valnbits-1..0
end function

```

The earlier examples can be expressed as

```

(offset15)GPRLEN-(16+2) || offset || 02

```

```
= sign_extend.16(offset) << 2)
```

and

```
sign_extend(temp31..0)
= sign_extend.32(temp)
```

Similarly for `zero_extension`, although zero extension is less common than sign extension in the MIPS ISA.

Floating point may use notations such as `zero_extend.fmt` corresponding to the format of the FPU instruction. E.g. `zero_extend.S` and `zero_extend.D` are equivalent to `zero_extend.32` and `zero_extend.64`.

Existing pseudocode may use any of these, or other, notations.

2.2.2.4.2 memory_address

The pseudocode function `memory_address` performs mode-dependent address space wrapping for compatibility between MIPS32 and MIPS64. It is applied to all memory references. It may be specified explicitly in some places, particularly for new memory reference instructions, but it is also declared to apply implicitly to all memory references as defined below. In addition, certain instructions that are used to calculate effective memory addresses but which are not themselves memory accesses specify `memory_address` explicitly in their pseudocode.

Figure 2.28 memory_address Pseudocode Function

```
function memory_address(ea)
    return ea
end function
```

On a 32-bit CPU, `memory_address` returns its 32-bit effective address argument unaffected.

In addition to the use of `memory_address` for all memory references (including load and store instructions, LL/SC), Release 6 extends this behavior to control transfers (branch and call instructions), and to the PC-relative address calculation instructions (ADDIUPC, AUIPC, ALUIPC). In newer instructions the function is explicit in the pseudocode.

Implicit address space wrapping for all instruction fetches is described by the following pseudocode fragment which should be considered part of instruction fetch:

Figure 2.29 Instruction Fetch Implicit memory_address Wrapping

```
PC ← memory_address( PC )
( instruction_data, length ) ← instruction_fetch( PC )
/* decode and execute instruction */
```

Implicit address space wrapping for all data memory accesses is described by the following pseudocode, which is inserted at the top of the `AddressTranslation` pseudocode function:

Figure 2.30 AddressTranslation implicit memory_address Wrapping

```
(pAddr, CCA) ← AddressTranslation( vAddr, IorD, LorS )
    vAddr ← memory_address( vAddr )
```

In addition to its use in instruction pseudocode,

2.2.2.5 Miscellaneous Functions

This section lists miscellaneous functions not covered in previous sections.

2.2.2.5.1 SignalException

The SignalException function signals an exception condition.

This action results in an exception that aborts the instruction. The instruction operation pseudocode never sees a return from this function call.

Figure 2.31 SignalException Pseudocode Function

```
SignalException(Exception, argument)

/* Exception:   The exception condition that exists. */
/* argument:   A exception-dependent argument, if any */

endfunction SignalException
```

2.2.2.5.2 SignalDebugBreakpointException

The SignalDebugBreakpointException function signals a condition that causes entry into Debug Mode from non-Debug Mode.

This action results in an exception that aborts the instruction. The instruction operation pseudocode never sees a return from this function call.

Figure 2.32 SignalDebugBreakpointException Pseudocode Function

```
SignalDebugBreakpointException()

endfunction SignalDebugBreakpointException
```

2.2.2.5.3 SignalDebugModeBreakpointException

The SignalDebugModeBreakpointException function signals a condition that causes entry into Debug Mode from Debug Mode (i.e., an exception generated while already running in Debug Mode).

This action results in an exception that aborts the instruction. The instruction operation pseudocode never sees a return from this function call.

Figure 2.33 SignalDebugModeBreakpointException Pseudocode Function

```
SignalDebugModeBreakpointException()

endfunction SignalDebugModeBreakpointException
```

2.2.2.5.4 NullifyCurrentInstruction

The NullifyCurrentInstruction function nullifies the current instruction.

The instruction is aborted, inhibiting not only the functional effect of the instruction, but also inhibiting all exceptions detected during fetch, decode, or execution of the instruction in question. For branch-likely instructions, nullification kills the instruction in the delay slot of the branch likely instruction.

Figure 2.34 NullifyCurrentInstruction PseudoCode Function

```
NullifyCurrentInstruction()
```

```
endfunction NullifyCurrentInstruction
```

2.2.2.5.5 PolyMult

The PolyMult function multiplies two binary polynomial coefficients.

Figure 2.35 PolyMult Pseudocode Function

```
PolyMult(x, y)
  temp ← 0
  for i in 0 .. 31
    if  $x_i = 1$  then
      temp ← temp xor ( $y_{(31-i)..0} || 0^i$ )
    endif
  endfor

  PolyMult ← temp

endfunction PolyMult
```

2.3 Op and Function Subfield Notation

In some instructions, the instruction subfields *op* and *function* can have constant 5- or 6-bit values. When reference is made to these instructions, uppercase mnemonics are used. For instance, in the floating point ADD instruction, *op*=COP1 and *function*=ADD. In other cases, a single field has both fixed and variable subfields, so the name contains both upper- and lowercase characters.

2.4 FPU Instructions

In the detailed description of each FPU instruction, all variable subfields in an instruction format (such as *fs*, *ft*, *immediate*, and so on) are shown in lowercase. The instruction name (such as ADD, SUB, and so on) is shown in uppercase.

For the sake of clarity, an alias is sometimes used for a variable subfield in the formats of specific instructions. For example, *rs=base* in the format for load and store instructions. Such an alias is always lowercase since it refers to a variable subfield.

Bit encodings for mnemonics are given in Volume I, in the chapters describing the CPU, FPU, MDMX, and MIPS16e instructions.

See “Op and Function Subfield Notation” on page 27 for a description of the *op* and *function* subfields.

The MIPS32® Instruction Set

3.1 Compliance and Subsetting

To be compliant with the MIPS32 Architecture, designs must implement a set of required features, as described in this document set. To allow implementation flexibility, the MIPS32 Architecture provides subsetting rules. An implementation that follows these rules is compliant with the MIPS32 Architecture as long as it adheres strictly to the rules, and fully implements the remaining instructions. Supersetting of the MIPS32 Architecture is only allowed by adding functions to the *SPECIAL2*, *COP2*, or both major opcodes, by adding control for co-processors via the *COP2*, *LWC2*, *SWC2*, *LDC2*, and/or *SDC2*, or via the addition of approved Application Specific Extensions.

Release 6 removes all instructions under the *SPECIAL2* major opcode, either by removing them or moving them to the *COP2* major opcode. All coprocessor 2 support instructions (for example, *LWC2*) have been moved to the *COP2* major opcode. Supersetting of the Release 6 architecture is only allowed in the *COP2* major opcode, or via the addition of approved Application Specific Extensions. *SPECIAL2* is reserved for MIPS.

Note: The use of *COP3* as a customizable coprocessor has been removed in the Release 2 of the MIPS32 architecture. The *COP3* is reserved for the future extension of the architecture. Implementations using Release 1 of the MIPS32 architecture are strongly discouraged from using the *COP3* opcode for a user-available coprocessor as doing so will limit the potential for an upgrade path to a 64-bit floating point unit.

The instruction set subsetting rules are described in the subsections below, and also the following rule:

- **Co-dependence of Architecture Features:** MIPSr5™ (also called Release 5) and subsequent releases (such as Release 6) include a number of features. Some are optional; some are required. Features provided by a release, such as MIPSr5 or later, whether optional or required, must be consistent. If any feature that is introduced by a particular release is implemented (such as a feature described as part of Release 5 and not any earlier release) then all other features must be implemented in a manner consistent with that release. For example: the *VZ* and *MSA* features are introduced by Release 5 but are optional. The *FR=1* 64-bit FPU register model was optional when introduced earlier, but is now required by Release 5 if any FPU is implemented. If any or all of *VZ* or *MSA* are implemented, then Release 5 is implied, and then if an FPU is implemented, it must implement the *FR=1* 64-bit FPU register model.

3.1.1 Subsetting of Non-Privileged Architecture

- All non-privileged (do not need access to Coprocessor 0) CPU (non-FPU) instructions must be implemented — no subsetting of these are allowed — per the MIPS Instruction Set Architecture release supported.
- If any instruction is subsetting out based on the rules below, an attempt to execute that instruction must cause the appropriate exception (typically Reserved Instruction or Coprocessor Unusable).
- The FPU and related support instructions, such as CPU conditional branches on FPU conditions (pre-Release 6 *BC1T/BC1F*, Release 6 *BC1NEQZ*) and CPU conditional moves on FPU conditions (pre-Release 6 *MOVTF/MOVVF*), may be omitted. Software may determine if an FPU is implemented by checking the state of the *FP* bit in the *Config1* CP0 register. Software may determine which FPU data types are implemented by checking the

appropriate bits in the *FIR* CP1 register. The following allowable FPU subsets are compliant with the MIPS32 architecture:

- No FPU

Config1.FP=0

- FPU with S, and W formats and all supporting instructions.

This 32-bit subset is permitted by Release 6, but prohibited by pre-Release 6 releases.

Config1.FP=1, Status.FR=0, FIR.S=FIR.L=1, FIR.D=FIR.L=FIR.PS=0.

- FPU with S, D, W, and L formats and all supporting instructions

Config1.FP=1, Status.FR=(see below), FIR.S=FIR.L=FIR.D=FIR.L=1, FIR.PS=0.

pre-MIPSR5 permits this 64-bit configuration, and allows both FPU register modes. Status.FR=0 support is required but Status.FR=1 support is optional.

MIPSR5 permits this 64-bit configuration, and requires both FPU register modes, i.e. both Status.FR=0 and Status.FR=1 support are required.

Release 6 permits this 64-bit configuration, but requires Status.FR=1 and FIR.F64=1. Release 6 prohibits Status.FR=0 if FIR.D=1 or FIR.L=1.

- FPU with S, D, PS, W, and L formats and all supporting instructions

Config1.FP=1, Status.FR=0/1, FIR.S=FIR.L=FIR.D=FIR.L=FIR.PS=1.

Release 6 prohibits this mode, and any mode with FIR.PS=1 paired single support.

- In Release 5 of the Architecture, if floating point is implemented then FR=1 is required. I.e. the 64-bit FPU, with the FR=1 64-bit FPU register model, is required. The FR=0 32-bit FPU register model continues to be required.
- Coprocessor 2 is optional and may be omitted. Software may determine if Coprocessor 2 is implemented by checking the state of the C2 bit in the *Config1* CP0 register. If Coprocessor 2 is implemented, the Coprocessor 2 interface instructions (BC2, CFC2, COP2, CTC2, LDC2, LWC2, MFC2, MTC2, SDC2, and SWC2) may be omitted on an instruction-by-instruction basis.
- The caches are optional. The *Config1*_{DL} and *Config1*_{IL} fields denote whether the first level caches are present or not.
- Instruction, CP0 Register, and CP1 Control Register fields that are marked “Reserved” or shown as “0” in the description of that field are reserved for future use by the architecture and are not available to implementations. Implementations may only use those fields that are explicitly reserved for implementation dependent use.
- Supported Modules/ASEs are optional and may be subsetting out. In most cases, software may determine if a supported Module/ASE is implemented by checking the appropriate bit in the *Config1* or *Config3* or *Config4* CP0 register. If they are implemented, they must implement the entire ISA applicable to the component, or implement subsets that are approved by the Module/ASE specifications.

- EJTAG is optional and may be subsetted out. If it is implemented, it must implement only those subsets that are approved by the EJTAG specification. If EJTAG is not implemented, the EJTAG instructions (SDBBP and DERET) can be subsetted out.
- In MIPS Release 3, there are two architecture branches (MIPS32/64 and microMIPS32/64). A single device is allowed to implement both architecture branches. The Privileged Resource Architecture (COP0) registers do not mode-switch in width (32-bit vs. 64-bit). For this reason, if a device implements both architecture branches, the address/data widths must be consistent. If a device implements MIPS64 and also implements microMIPS, it must implement microMIPS64 not just microMIPS32. Similarly, if a device implements microMIPS64 and also implements MIPS32/64, it must implement MIPS64 not just MIPS32.
- Prior to Release 6, the JALX instruction is required if and only if ISA mode-switching is possible. If both of the architecture branches are implemented (MIPS32/64 and microMIPS32/64) or if MIPS16e is implemented then the JALX instructions are required. If only one branch of the architecture family and MIPS16e is not implemented then the JALX instruction is not implemented. The JALX instruction was removed in Release 6.

3.2 Alphabetical List of Instructions

The following pages present detailed descriptions of instructions, arranged alphabetical order of opcode mnemonic (except where several similar instructions are described together.)

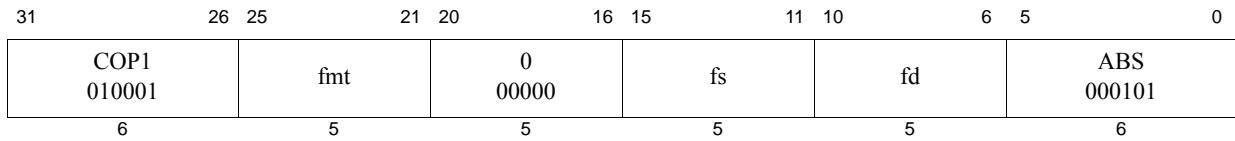

Format: ABS.fmt

ABS.S fd, fs

ABS.D fd, fs

ABS.PS fd, fs

MIPS32

MIPS32

MIPS64, MIPS32 Release 2, removed in Release 6

Purpose: Floating Point Absolute Value

Description: $FPR[fd] \leftarrow \text{abs}(FPR[fs])$

The absolute value of the value in FPR *fs* is placed in FPR *fd*. The operand and result are values in format *fmt*. ABS.PS takes the absolute value of the two values in FPR *fs* independently, and ORs together any generated exceptions.

The *Cause* bits are ORed into the *Flag* bits if no exception is taken.

If $FIR_{Has2008}=0$ or $FCSR_{ABS2008}=0$ then this operation is arithmetic. For this case, any NaN operand signals invalid operation.

If $FCSR_{ABS2008}=1$ then this operation is non-arithmetic. For this case, both regular floating point numbers and NaN values are treated alike, only the sign bit is affected by this instruction. No IEEE exception can be generated for this case, and the $FCSR_{Cause}$ and $FCSR_{Flags}$ fields are not modified.

Restrictions:

The fields *fs* and *fd* must specify FPRs valid for operands of type *fmt*. If the fields are not valid, the result is **UNPREDICTABLE**.

The operand must be a value in format *fmt*; if it is not, the result is **UNPREDICTABLE** and the value of the operand FPR becomes **UNPREDICTABLE**.

The result of ABS.PS is **UNPREDICTABLE** if the processor is executing in the $FR=0$ 32-bit FPU register model. ABS.PS is predictable if executing on a 64-bit FPU in the $FR=1$ mode, but not with $FR=0$, and not on a 32-bit FPU.

Availability and Compatibility:

ABS.PS has been removed in Release 6.

Operation:

```
StoreFPR(fd, fmt, AbsoluteValue(ValueFPR(fs, fmt)))
```

Exceptions:

Coprocessor Unusable, Reserved Instruction

Floating Point Exceptions:

Unimplemented Operation, Invalid Operation

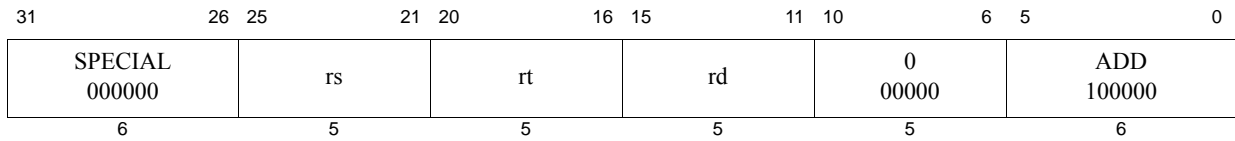

Format: ADD *rd*, *rs*, *rt*

MIPS32

Purpose: Add Word

To add 32-bit integers. If an overflow occurs, then trap.

Description: $GPR[rd] \leftarrow GPR[rs] + GPR[rt]$

The 32-bit word value in GPR *rt* is added to the 32-bit value in GPR *rs* to produce a 32-bit result.

- If the addition results in 32-bit 2's complement arithmetic overflow, the destination register is not modified and an Integer Overflow exception occurs.
- If the addition does not overflow, the 32-bit result is placed into GPR *rd*.

Restrictions:

None

Operation:

```
temp ← (GPR[rs]31 | GPR[rs]31..0) + (GPR[rt]31 | GPR[rt]31..0)
if temp32 ≠ temp31 then
    SignalException(IntegerOverflow)
else
    GPR[rd] ← temp
endif
```

Exceptions:

Integer Overflow

Programming Notes:

ADDU performs the same arithmetic operation but does not trap on overflow.

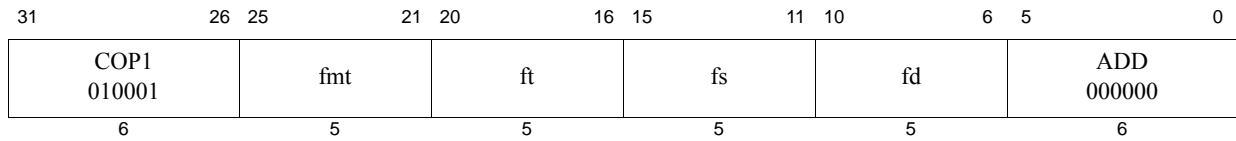

Format: ADD.fmt
 ADD.S fd, fs, ft
 ADD.D fd, fs, ft
 ADD.PS fd, fs, ft

MIPS32
MIPS32
MIPS64, MIPS32 Release 2, removed in Release 6

Purpose: Floating Point Add

To add floating point values.

Description: $FPR[fd] \leftarrow FPR[fs] + FPR[ft]$

The value in FPR *ft* is added to the value in FPR *fs*. The result is calculated to infinite precision, rounded by using to the current rounding mode in *FCSR*, and placed into FPR *fd*. The operands and result are values in format *fmt*.

ADD.PS adds the upper and lower halves of FPR *fs* and FPR *ft* independently, and ORs together any generated exceptions.

The *Cause* bits are ORed into the *Flag* bits if no exception is taken.

Restrictions:

The fields *fs*, *ft*, and *fd* must specify FPRs valid for operands of type *fmt*. If the fields are not valid, the result is **UNPREDICTABLE**.

The operands must be values in format *fmt*. If the fields are not, the result is **UNPREDICTABLE** and the value of the operand FPRs becomes **UNPREDICTABLE**.

The result of ADD.PS is **UNPREDICTABLE** if the processor is executing in the *FR=0* 32-bit FPU register model. ADD.PS is predictable if executing on a 64-bit FPU in the *FR=1* mode, but not with *FR=0*, and not on a 32-bit FPU.

Availability and Compatibility:

ADD.PS has been removed in Release 6.

Operation:

StoreFPR (fd, fmt, ValueFPR(fs, fmt) +_{fmt} ValueFPR(ft, fmt))

Exceptions:

Coprocessor Unusable, Reserved Instruction

Floating Point Exceptions:

Unimplemented Operation, Invalid Operation, Inexact, Overflow, Underflow

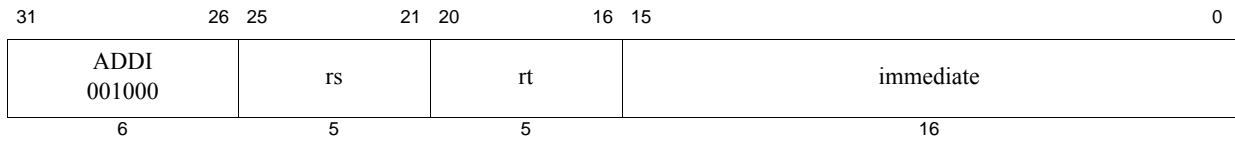

Format: ADDI *rt*, *rs*, *immediate*

MIPS32, removed in Release 6

Purpose: Add Immediate Word

To add a constant to a 32-bit integer. If overflow occurs, then trap.

Description: $GPR[rt] \leftarrow GPR[rs] + \text{immediate}$

The 16-bit signed *immediate* is added to the 32-bit value in GPR *rs* to produce a 32-bit result.

- If the addition results in 32-bit 2's complement arithmetic overflow, the destination register is not modified and an Integer Overflow exception occurs.
- If the addition does not overflow, the 32-bit result is placed into GPR *rt*.

Restrictions:

Availability and Compatibility:

This instruction has been removed in Release 6. The encoding has been reused for other instructions introduced by Release 6.

Operation:

```
temp ← (GPR[rs]31 | GPR[rs]31..0) + sign_extend(immediate)
if temp32 ≠ temp31 then
    SignalException(IntegerOverflow)
else
    GPR[rt] ← temp
endif
```

Exceptions:

Integer Overflow

Programming Notes:

ADDIU performs the same arithmetic operation but does not trap on overflow.

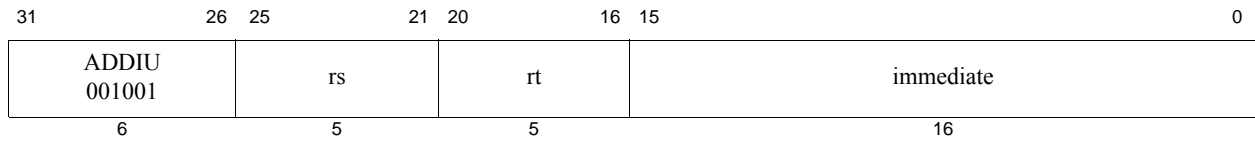

Format: ADDIU *rt*, *rs*, *immediate*

MIPS32

Purpose: Add Immediate Unsigned Word

To add a constant to a 32-bit integer.

Description: $GPR[rt] \leftarrow GPR[rs] + immediate$

The 16-bit signed *immediate* is added to the 32-bit value in GPR *rs* and the 32-bit arithmetic result is placed into GPR *rt*.

No Integer Overflow exception occurs under any circumstances.

Restrictions:

None

Operation:

```
temp ← GPR[rs] + sign_extend(immediate)
GPR[rt] ← temp
```

Exceptions:

None

Programming Notes:

The term “unsigned” in the instruction name is a misnomer; this operation is 32-bit modulo arithmetic that does not trap on overflow. This instruction is appropriate for unsigned arithmetic, such as address arithmetic, or integer arithmetic environments that ignore overflow, such as C language arithmetic.

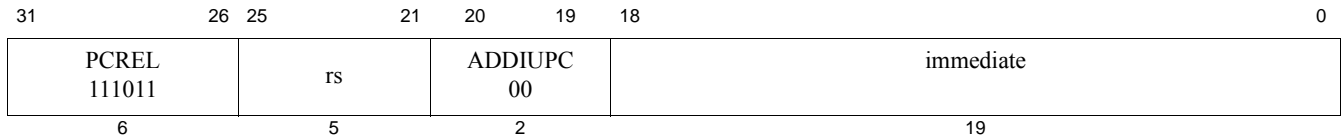

Format: ADDIUPC *rs*, *immediate*

MIPS32 Release 6

Purpose: Add Immediate to PC (unsigned - non-trapping)

Description: $GPR[rs] \leftarrow (PC + \text{sign_extend}(\text{immediate} \ll 2))$

This instruction performs a PC-relative address calculation. The 19-bit immediate is shifted left by 2 bits, sign-extended, and added to the address of the ADDIUPC instruction. The result is placed in GPR *rs*.

Restrictions:

None

Availability and Compatibility:

This instruction is introduced by and required as of Release 6.

Operation:

$$GPR[rs] \leftarrow (PC + \text{sign_extend}(\text{immediate} \ll 2))$$

Exceptions:

None

Programming Notes:

The term “unsigned” in this instruction mnemonic is a misnomer. “Unsigned” here means “non-trapping”. It does not trap on a signed 32-bit overflow. ADDIUPC corresponds to unsigned ADDIU, which does not trap on overflow, as opposed to ADDI, which does trap on overflow.

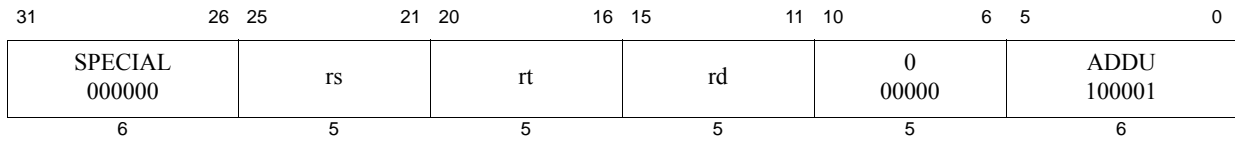

Format: ADDU *rd*, *rs*, *rt*

MIPS32

Purpose: Add Unsigned Word

To add 32-bit integers.

Description: $GPR[rd] \leftarrow GPR[rs] + GPR[rt]$

The 32-bit word value in GPR *rt* is added to the 32-bit value in GPR *rs* and the 32-bit arithmetic result is placed into GPR *rd*.

No Integer Overflow exception occurs under any circumstances.

Restrictions:

None

Operation:

```
temp ← GPR[rs] + GPR[rt]
GPR[rd] ← temp
```

Exceptions:

None

Programming Notes:

The term “unsigned” in the instruction name is a misnomer; this operation is 32-bit modulo arithmetic that does not trap on overflow. This instruction is appropriate for unsigned arithmetic, such as address arithmetic, or integer arithmetic environments that ignore overflow, such as C language arithmetic.

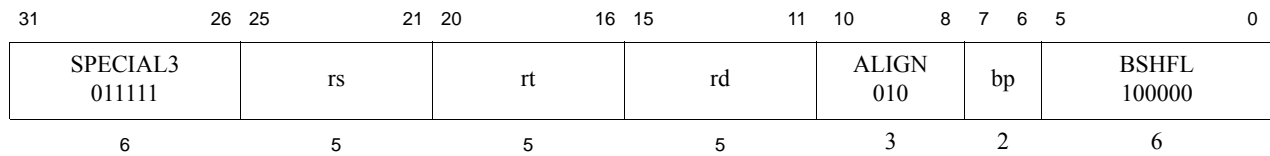

Format: ALIGN
ALIGN rd,rs,rt,bp

MIPS32 Release 6

Purpose: Concatenate two GPRs, and extract a contiguous subset at a byte position

Description: $GPR[rd] \leftarrow (GPR[rt] \ll (8 * bp)) \text{ or } (GPR[rs] \gg (GPRLEN - 8 * bp))$

The input registers GPR *rt* and GPR *rs* are concatenated, and a register width contiguous subset is extracted, which is specified by the byte pointer *bp*.

The ALIGN instruction operates on 32-bit words, and has a 2-bit byte position field *bp*.

- The 32-bit word in GPR *rt* is left shifted as a 32-bit value by *bp* byte positions. The 32-bit word in register *rs* is right shifted as a 32-bit value by $(4 - bp)$ byte positions. These shifts are logical shifts, zero-filling. The shifted values are then *or*-ed together to create a 32-bit result that is written to destination GPR *rd*.

Restrictions:

Executing ALIGN with shift count $bp=0$ acts like a register to register move operation, and is redundant, and therefore discouraged. Software should not generate ALIGN with shift count $bp=0$.

Availability and Compatibility:

The ALIGN instruction is introduced by and required as of Release 6.

Programming Notes:

Release 6 ALIGN instruction corresponds to the pre-Release 6 DSP Module BALIGN instruction, except that BALIGN with shift counts of 0 and 2 are specified as being UNPREDICTABLE, whereas ALIGN defines all *bp* values, discouraging only $bp=0$.

Graphically,

Figure 3.1 ALIGN operation (32-bit)

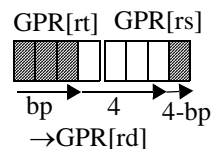

Operation:

```
tmp_rt_hi ← unsigned_word(GPR[rt]) << (8 * bp)
tmp_rs_lo ← unsigned_word(GPR[rs]) >> (8 * (4 - bp))
tmp ← tmp_rt_hi or tmp_rs_lo

GPR[rd] ← tmp
/* end of instruction */
```

Exceptions:

None

31	26 25	21 20	16 15	11 10	6 5	0
COPIX 010011	rs	ft	fs	fd	ALNV.PS 011110	
6	5	5	5	5	6	

Format: ALNV.PS *fd*, *fs*, *ft*, *rs*

MIPS64,MIPS32 Release 2, removed in Release 6

Purpose: Floating Point Align Variable

To align a misaligned pair of paired single values.

Description: $FPR[fd] \leftarrow \text{ByteAlign}(GPR[rs]_{2..0}, FPR[fs], FPR[ft])$

FPR *fs* is concatenated with FPR *ft* and this value is funnel-shifted by GPR *rs*_{2..0} bytes, and written into FPR *fd*. If GPR *rs*_{2..0} is 0, FPR *fd* receives FPR *fs*. If GPR *rs*_{2..0} is 4, the operation depends on the current endianness.

Figure 3-1 illustrates the following example: for a big-endian operation and a byte alignment of 4, the upper half of FPR *fd* receives the lower half of the paired single value in *fs*, and the lower half of FPR *fd* receives the upper half of the paired single value in *ft*.

Figure 3.2 Example of an ALNV.PS Operation

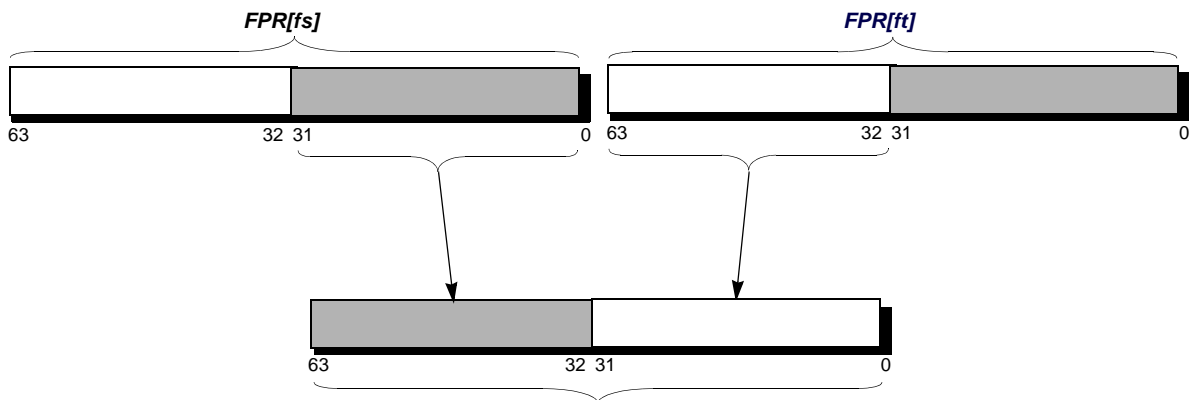

The move is non arithmetic; it causes no IEEE 754 exceptions, and the $FCSR_{Cause}$ and $FCSR_{Flags}$ fields are not modified.

Restrictions:

The fields *fs*, *ft*, and *fd* must specify FPRs valid for operands of type *PS*. If the fields are not valid, the result is **UNPREDICTABLE**.

If GPR *rs*_{1..0} are non-zero, the results are **UNPREDICTABLE**.

The result of this instruction is **UNPREDICTABLE** if the processor is executing in the $FR=0$ 32-bit FPU register model. The instruction is predictable if executing on a 64-bit FPU in the $FR=1$ mode, but not with $FR=0$, and not on a 32-bit FPU.

Availability and Compatibility:

This instruction has been removed in Release 6.

Operation:

```
if GPR[rs]2..0 = 0 then
```

```

    StoreFPR(fd, PS, ValueFPR(fs, PS))
else if GPR[rs]2..0 ≠ 4 then
    UNPREDICTABLE
else if BigEndianCPU then
    StoreFPR(fd, PS, ValueFPR(fs, PS)31..0 || ValueFPR(ft, PS)63..32)
else
    StoreFPR(fd, PS, ValueFPR(ft, PS)31..0 || ValueFPR(fs, PS)63..32)
endif

```

Exceptions:

Coprocessor Unusable, Reserved Instruction

Programming Notes:

ALNV.PS is designed to be used with LUXC1 to load 8 bytes of data from any 4-byte boundary. For example:

```

/* Copy T2 bytes (a multiple of 16) of data T0 to T1, T0 unaligned, T1 aligned.
   Reads one dw beyond the end of T0. */
LUXC1    F0, 0(T0) /* set up by reading 1st src dw */
LI       T3, 0     /* index into src and dst arrays */
ADDIU    T4, T0, 8 /* base for odd dw loads */
ADDIU    T5, T1, -8/* base for odd dw stores */
LOOP:
LUXC1    F1, T3(T4)
ALNV.PS  F2, F0, F1, T0/* switch F0, F1 for little-endian */
SDC1     F2, T3(T1)
ADDIU    T3, T3, 16
LUXC1    F0, T3(T0)
ALNV.PS  F2, F1, F0, T0/* switch F1, F0 for little-endian */
BNE      T3, T2, LOOP
SDC1     F2, T3(T5)
DONE:

```

ALNV.PS is also useful with SUXC1 to store paired-single results in a vector loop to a possibly misaligned address:

```

/* T1[i] = T0[i] + F8, T0 aligned, T1 unaligned. */
   CVT.PS.S F8, F8, F8/* make addend paired-single */

/* Loop header computes 1st pair into F0, stores high half if T1 */
/* misaligned */

LOOP:
LDC1     F2, T3(T4)/* get T0[i+2]/T0[i+3] */
ADD.PS   F1, F2, F8/* compute T1[i+2]/T1[i+3] */
ALNV.PS  F3, F0, F1, T1/* align to dst memory */
SUXC1    F3, T3(T1)/* store to T1[i+0]/T1[i+1] */
ADDIU    T3, 16     /* i = i + 4 */
LDC1     F2, T3(T0)/* get T0[i+0]/T0[i+1] */
ADD.PS   F0, F2, F8/* compute T1[i+0]/T1[i+1] */
ALNV.PS  F3, F1, F0, T1/* align to dst memory */
BNE      T3, T2, LOOP
SUXC1    F3, T3(T5)/* store to T1[i+2]/T1[i+3] */

/* Loop trailer stores all or half of F0, depending on T1 alignment */

```

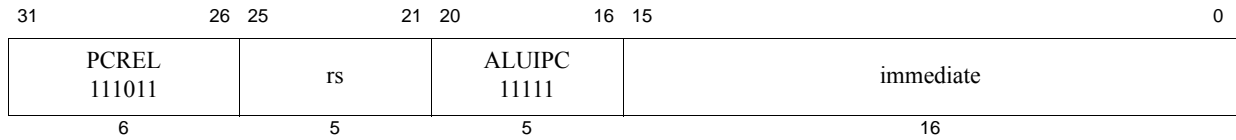

Format: ALUIPC *rs*,*immediate*

MIPS32 Release 6

Purpose: Aligned Add Upper Immediate to PC

Description: $GPR[rs] \leftarrow \sim 0x0FFFF \& (PC + \text{sign_extend}(\text{immediate} \ll 16))$

This instruction performs a PC-relative address calculation. The 16-bit immediate is shifted left by 16 bits, sign-extended, and added to the address of the ALUIPC instruction. The low 16 bits of the result are cleared, that is the result is aligned on a 64K boundary. The result is placed in GPR *rs*.

Restrictions:

None

Availability and Compatibility:

This instruction is introduced by and required as of Release 6.

Operation:

$GPR[rs] \leftarrow \sim 0x0FFFF \& (PC + \text{sign_extend}(\text{immediate} \ll 16))$

Exceptions:

None

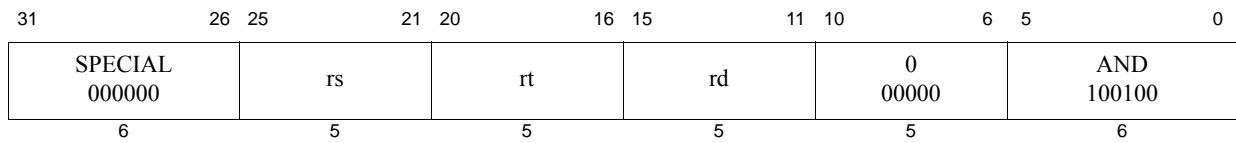

Format: AND *rd*, *rs*, *rt*

MIPS32

Purpose: and

To do a bitwise logical AND.

Description: $GPR[rd] \leftarrow GPR[rs] \text{ and } GPR[rt]$

The contents of GPR *rs* are combined with the contents of GPR *rt* in a bitwise logical AND operation. The result is placed into GPR *rd*.

Restrictions:

None

Operation:

$GPR[rd] \leftarrow GPR[rs] \text{ and } GPR[rt]$

Exceptions:

None

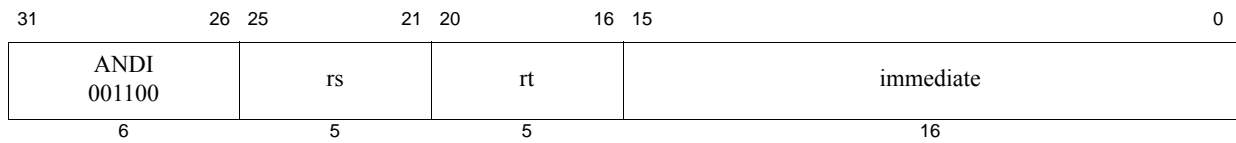

Format: ANDI *rt*, *rs*, *immediate*

MIPS32

Purpose: and immediate

To do a bitwise logical AND with a constant

Description: $GPR[rt] \leftarrow GPR[rs] \text{ and } \text{zero_extend}(\text{immediate})$

The 16-bit immediate is zero-extended to the left and combined with the contents of GPR *rs* in a bitwise logical AND operation. The result is placed into GPR *rt*.

Restrictions:

None

Operation:

$GPR[rt] \leftarrow GPR[rs] \text{ and } \text{zero_extend}(\text{immediate})$

Exceptions:

None

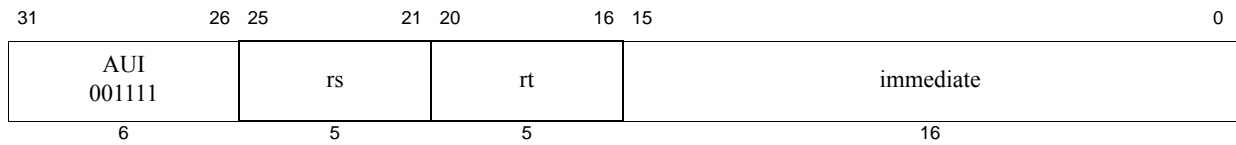

Format: AUI rt, rs immediate

MIPS32 Release 6

Purpose: Add Immediate to Upper Bits

Add Upper Immediate

Description:

```
GPR[rt] ← GPR[rs] + sign_extend(immediate << 16)
```

The 16 bit immediate is shifted left 16 bits, sign-extended, and added to the register *rs*, storing the result in *rt*.

In Release 6, LUI is an assembly idiom for AUI with *rs*=0.

Restrictions:

Availability and Compatibility:

AUI is introduced by and required as of Release 6.

Operation:

```
GPR[rt] ← GPR[rs] + sign_extend(immediate << 16)
```

Exceptions:

None.

Programming Notes:

AUI can be used to synthesize large constants in situations where it is not convenient to load a large constant from memory. To simplify hardware that may recognize sequences of instructions as generating large constants, AUI should be used in a stylized manner.

To create an integer:

```
LUI rd, imm_low(rtmp)
ORI rd, rd, imm_upper
```

To create a large offset for a memory access whose address is of the form *rbase*+*large_offset*:

```
AUI rtmp, rbase, imm_upper
LW rd, (rtmp)imm_low
```

To create a large constant operand for an instruction of the form *rd:=rs*+*large_immediate*
or *rd:=rs*-*large_immediate*:

```
AUI rtmp, rs, imm_upper
ADDIU rd, rtmp, imm_low
```

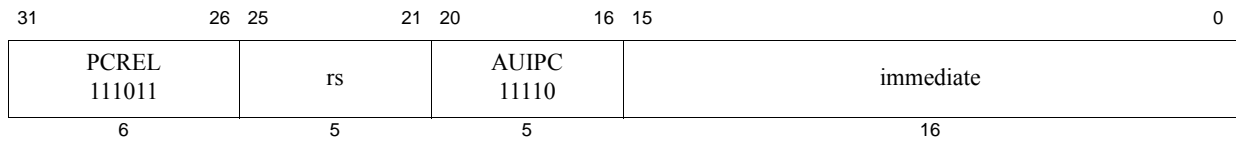

Format: AUIPC rs, immediate

MIPS32 Release 6

Purpose: Add Upper Immediate to PC

Description: $GPR[rs] \leftarrow (PC + (immediate \ll 16))$

This instruction performs a PC-relative address calculation. The 16-bit immediate is shifted left by 16 bits, sign-extended, and added to the address of the AUIPC instruction. The result is placed in GPR *rs*.

Restrictions:

None

Availability and Compatibility:

This instruction is introduced by and required as of Release 6.

Operation:

$GPR[rs] \leftarrow (PC + (immediate \ll 16))$

Exceptions:

None

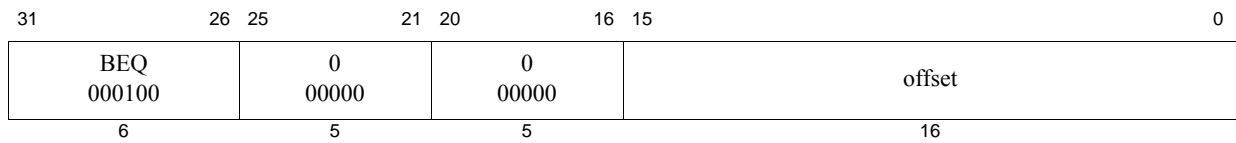

Format: B offset

Assembly Idiom

Purpose: Unconditional Branch

To do an unconditional branch.

Description: branch

B offset is the assembly idiom used to denote an unconditional branch. The actual instruction is interpreted by the hardware as BEQ r0, r0, offset.

An 18-bit signed offset (the 16-bit *offset* field shifted left 2 bits) is added to the address of the instruction following the branch (not the branch itself), in the branch delay slot, to form a PC-relative effective target address.

Restrictions:

Control Transfer Instructions (CTIs) should not be placed in branch delay slots or Release 6 forbidden slots. CTIs include all branches and jumps, NAL, ERET, ERETNC, DERET, WAIT, and PAUSE.

Pre-Release 6: Processor operation is **UNPREDICTABLE** if a control transfer instruction (CTI) is placed in the delay slot of a branch or jump.

Release 6: If a control transfer instruction (CTI) is executed in the delay slot of a branch or jump, Release 6 implementations are required to signal a Reserved Instruction exception.

Operation:

```
I:   target_offset ← sign_extend(offset || 02)
I+1: PC ← PC + target_offset
```

Exceptions:

None

Programming Notes:

With the 18-bit signed instruction offset, the conditional branch range is ± 128 Kbytes. Use jump (J) or jump register (JR) or the Release 6 branch compact (BC) instructions to branch to addresses outside this range.

pre-Release 6:

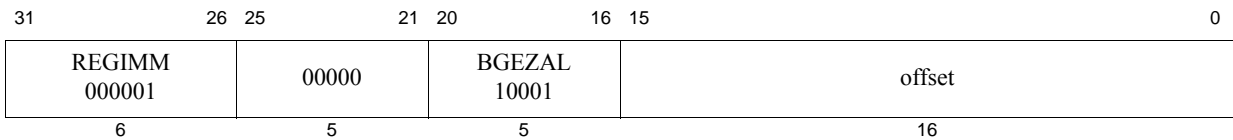

Release 6:

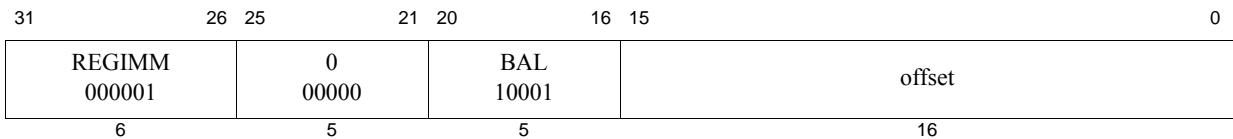
**Format:** BAL offset**Assembly Idiom MIPS32, MIPS32 Release 6****Purpose:** Branch and Link

To do an unconditional PC-relative procedure call.

Description: procedure_call

Place the return address link in GPR 31. The return link is the address of the second instruction following the branch, where execution continues after a procedure call.

An 18-bit signed offset (the 16-bit *offset* field shifted left 2-bits) is added to the address of the instruction following the branch (not the branch itself), in the branch delay slot, to form a PC-relative effective target address.

Restrictions:

Control Transfer Instructions (CTIs) should not be placed in branch delay slots or Release 6 forbidden slots. CTIs include all branches and jumps, NAL, ERET, ERETNC, DERET, WAIT, and PAUSE.

Pre-Release 6: Processor operation is **UNPREDICTABLE** if a control transfer instruction (CTI) is placed in the delay slot of a branch or jump.

Release 6: If a control transfer instruction (CTI) is executed in the delay slot of a branch or jump, Release 6 implementations are required to signal a Reserved Instruction exception.

Availability and Compatibility:

Pre-Release 6: BAL offset is the assembly idiom used to denote an unconditional branch. The actual instruction is interpreted by the hardware as BGEZAL r0, offset.

Release 6 keeps the BAL special case of BGEZAL, but removes all other instances of BGEZAL. BGEZAL with *rs* any register other than GPR [0] is required to signal a Reserved Instruction exception.

Operation:

```
I:   target_offset ← sign_extend(offset || 02)
      GPR[31] ← PC + 8
I+1: PC ← PC + target_offset
```

Exceptions:

None

Programming Notes:

BAL without a corresponding return should NOT be used to read the PC. Doing so is likely to cause a performance loss on processors with a return address predictor.

With the 18-bit signed instruction offset, the conditional branch range is ± 128 KBytes. Use jump and link (JAL) or jump and link register (JALR) instructions for procedure calls to addresses outside this range.

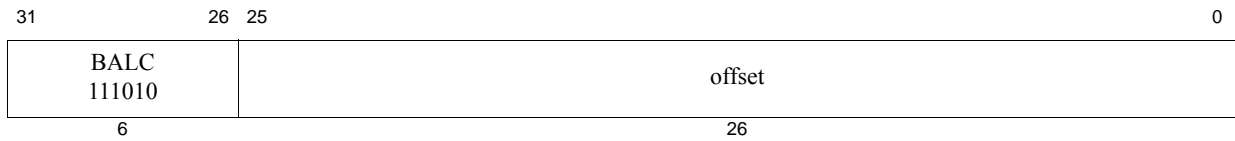

Format: BALC offset

MIPS32 Release 6

Purpose: Branch and Link, Compact

To do an unconditional PC-relative procedure call.

Description: `procedure_call` (no delay slot)

Place the return address link in GPR 31. The return link is the address of the instruction immediately following the branch, where execution continues after a procedure call. (Because compact branches have no delay slots, see below.)

A 28-bit signed offset (the 26-bit offset field shifted left 2 bits) is added to the address of the instruction following the branch (not the branch itself), to form a PC-relative effective target address.

Compact branches do not have delay slots. The instruction after the branch is NOT executed when the branch is taken.

Restrictions:

This instruction is an unconditional, always taken, compact branch. It does not have a forbidden slot, that is, a Reserved Instruction exception is not caused by a Control Transfer Instruction placed in the slot following the branch.

Availability and Compatibility:

This instruction is introduced by and required as of Release 6.

Release 6 instruction BALC occupies the same encoding as pre-Release 6 instruction SWC2. The SWC2 instruction has been moved to the COP2 major opcode in MIPS Release 6.

Exceptions:

None

Operation:

```
target_offset ← sign_extend( offset || 02 )
GPR[31] ← PC+4
PC ← PC+4 + sign_extend(target_offset)
```

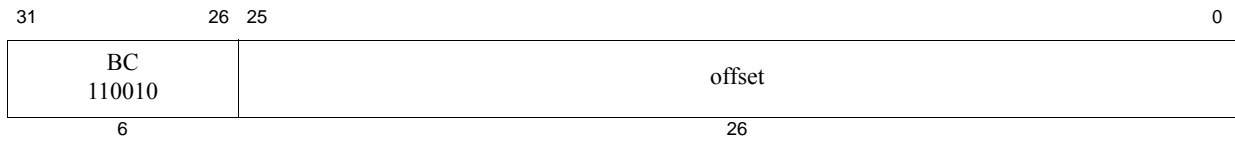

Format: BC offset

MIPS32 Release 6

Purpose: Branch, Compact

Description: $PC \leftarrow PC+4 + \text{sign_extend}(\text{offset} \ll 2)$

A 28-bit signed offset (the 26-bit offset field shifted left 2 bits) is added to the address of the instruction following the branch (not the branch itself), to form a PC-relative effective target address.

Compact branches have no delay slot: the instruction after the branch is NOT executed when the branch is taken.

Restrictions:

This instruction is an unconditional, always taken, compact branch. It does not have a forbidden slot, that is, a Reserved Instruction exception is not caused by a Control Transfer Instruction placed in the slot following the branch.

Availability and Compatibility:

This instruction is introduced by and required as of Release 6.

Release 6 instruction BC occupies the same encoding as pre-Release 6 instruction LWC2. The LWC2 instruction has been moved to the COP2 major opcode in MIPS Release 6.

Exceptions:

None

Operation:

```
target_offset ← sign_extend( offset || 02 )
PC ← ( PC+4 + sign_extend(target_offset) )
```

31	26 25	21 20	16 15	0
COP1 010001	BC1EQZ 01001	ft	offset	
COP1 010001	BC1NEZ 01101	ft	offset	
6	5	5	16	

Format: BC1EQZ BC1NEZ
 BC1EQZ ft, offset
 BC1NEZ ft, offset

MIPS32 Release 6
 MIPS32 Release 6

Purpose: Branch if Coprocessor 1 (FPU) Register Bit 0 Equal/Not Equal to Zero

BC1EQZ: Branch if Coprocessor 1 (FPU) Register Bit 0 is Equal to Zero

BC1NEZ: Branch if Coprocessor 1 (FPR) Register Bit 0 is Not Equal to Zero

Description:

BC1EQZ: if FPR[ft] & 1 = 0 then branch
 BC1NEZ: if FPR[ft] & 1 ≠ 0 then branch

The condition is evaluated on FPU register *ft*.

- For BC1EQZ, the condition is true if and only if bit 0 of the FPU register *ft* is zero.
- For BC1NEZ, the condition is true if and only if bit 0 of the FPU register *ft* is non-zero.

If the condition is false, the branch is not taken, and execution continues with the next instruction.

A 18-bit signed offset (the 16-bit offset field shifted left 2 bits) is added to the address of the instruction following the branch (not the branch itself), to form a PC-relative effective target address. Execute the instruction in the delay slot before the instruction at the target.

Restrictions:

If access to Coprocessor 1 is not enabled, a Coprocessor Unusable Exception is signaled.

Because these instructions BC1EQZ and BC1NEZ do not depend on a particular floating point data type, they operate whenever Coprocessor 1 is enabled.

Control Transfer Instructions (CTIs) should not be placed in branch delay slots or Release 6 forbidden slots. CTIs include all branches and jumps, NAL, ERET, ERETNC, DERET, WAIT, and PAUSE.

If a control transfer instruction (CTI) is executed in the delay slot of a branch or jump, Release 6 implementations are required to signal a Reserved Instruction exception.

Availability and Compatibility:

These instructions are introduced by and required as of Release 6.

Exceptions:

Coprocessor Unusable¹

Operation:

1. In Release 6, BC1EQZ and BC1NEZ are required, if the FPU is implemented. They must not signal a Reserved Instruction exception. They can signal a Coprocessor Unusable Exception.

```
tmp ← ValueFPR(ft, UNINTERPRETED_WORD)
BC1EQZ: cond ← tmp & 1 = 0
BC1NEZ: cond ← tmp & 1 ≠ 0
if cond then
    I:    target_PC ← ( PC+4 + sign_extend( offset << 2 )
    I+1:  PC ← target_PC
```

Programming Notes:

Release 6: These instructions, BC1EQZ and BC1NEZ, replace the pre-Release 6 instructions BC1F and BC1T. These Release 6 FPU branches depend on bit 0 of the scalar FPU register.

Note: BC1EQZ and BC1NEZ do not have a format or data type width. The same instructions are used for branches based on conditions involving any format, including 32-bit S (single precision) and W (word) format, and 64-bit D (double precision) and L (longword) format, as well as 128-bit MSA. The FPU scalar comparison instructions *CMP.condn.fmt* produce an all ones or all zeros truth mask of their format width with the upper bits (where applicable) UNPREDICTABLE. BC1EQZ and BC1NEZ consume only bit 0 of the *CMP.condn.fmt* output value, and therefore operate correctly independent of *fmt*.

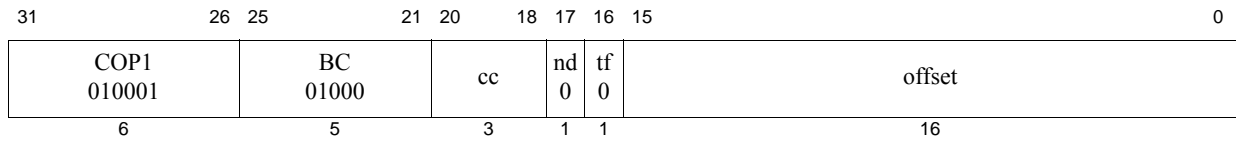

Format: BC1F offset (cc = 0 implied)
BC1F cc, offset

MIPS32, removed in Release 6
MIPS32, removed in Release 6

Purpose: Branch on FP False

To test an FP condition code and do a PC-relative conditional branch.

Description: if FPConditionCode(cc) = 0 then branch

An 18-bit signed offset (the 16-bit *offset* field shifted left 2 bits) is added to the address of the instruction following the branch (not the branch itself) in the branch delay slot to form a PC-relative effective target address. If the FP condition code bit *cc* is false (0), the program branches to the effective target address after the instruction in the delay slot is executed. An FP condition code is set by the FP compare instruction, C.cond.fmt.

Restrictions:

Processor operation is **UNPREDICTABLE** if a control transfer instruction (CTI) is placed in the delay slot of a branch or jump.

Availability and Compatibility:

This instruction has been removed in Release 6.

Operation:

```

I:   condition ← FPConditionCode(cc) = 0
      target_offset ← (offset15)GPRELEN-(16+2) || offset || 02
I+1: if condition then
      PC ← PC + target_offset
      endif

```

Exceptions:

Coprocessor Unusable, Reserved Instruction

Floating Point Exceptions:

Unimplemented Operation

Programming Notes:

With the 18-bit signed instruction offset, the conditional branch range is ± 128 KBytes. Use jump (J) or jump register (JR) to branch to addresses outside this range.

This instruction has been removed in Release 6 and has been replaced by the BC1EQZ instruction. Refer to the ‘BC1EQZ’ instruction in this manual for more information.

Historical Information:

The MIPS I architecture defines a single floating point condition code, implemented as the coprocessor 1 condition signal (*Cp1Cond*) and the *C* bit in the FP *Control/Status* register. MIPS I, II, and III architectures must have the *CC* field set to 0, which is implied by the first format in the “Format” section.

The MIPS IV and MIPS32 architectures add seven more *Condition Code* bits to the original condition code 0. FP compare and conditional branch instructions specify the *Condition Code* bit to set or test. Both assembler formats are

valid for MIPS IV and MIPS32.

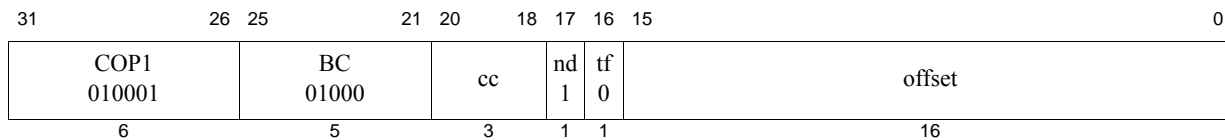

Format: BC1FL *offset* (*cc* = 0 implied)
 BC1FL *cc*, *offset*

MIPS32, removed in Release 6
MIPS32, removed in Release 6

Purpose: Branch on FP False Likely

To test an FP condition code and make a PC-relative conditional branch; execute the instruction in the delay slot only if the branch is taken.

Description: if `FPConditionCode(cc) = 0` then `branch_likely`

An 18-bit signed offset (the 16-bit *offset* field shifted left 2 bits) is added to the address of the instruction following the branch (not the branch itself) in the branch delay slot to form a PC-relative effective target address. If the FP *Condition Code* bit *cc* is false (0), the program branches to the effective target address after the instruction in the delay slot is executed. If the branch is not taken, the instruction in the delay slot is not executed.

An FP condition code is set by the FP compare instruction, `C.cond.fmt`.

Restrictions:

Processor operation is **UNPREDICTABLE** if a branch, jump, ERET, DERET, or WAIT instruction is placed in the delay slot of a branch or jump.

Availability and Compatibility:

This instruction has been removed in Release 6.

Operation:

This operation specification is for the general Branch On Condition operation with the *tf* (true/false) and *nd* (nullify delay slot) fields as variables. The individual instructions BC1F, BC1FL, BC1T, and BC1TL have specific values for *tf* and *nd*.

```

I:   condition ← FPConditionCode(cc) = 0
      target_offset ← (offset15)GPRLLEN-(16+2) || offset || 02
I+1: if condition then
      PC ← PC + target_offset
      else
      NullifyCurrentInstruction()
      endif
  
```

Exceptions:

Coprocessor Unusable, Reserved Instruction

Floating Point Exceptions:

Unimplemented Operation

Implementation Note:

Some implementations always predict that the branch will be taken, and do not use nor do they update the branch internal processor branch prediction tables for this instruction. To maintain performance compatibility, future implementations are encouraged to do the same.

Programming Notes:

With the 18-bit signed instruction offset, the conditional branch range is ± 128 KBytes. Use jump (J) or jump register (JR) to branch to addresses outside this range.

In Pre-Release 6 implementations, software is strongly encouraged to avoid the use of the Branch Likely instructions, as they will be removed from a future revision of the MIPS Architecture.

Some implementations always predict the branch will be taken, so there is a significant penalty if the branch is not taken. Software should only use this instruction when there is a very high probability (98% or more) that the branch will be taken. If the branch is not likely to be taken or if the probability of a taken branch is unknown, software is encouraged to use the BC1F instruction instead.

Historical Information:

The MIPS I architecture defines a single floating point condition code, implemented as the coprocessor 1 condition signal (*Cp1Cond*) and the *C* bit in the FP *Control/Status* register. MIPS I, II, and III architectures must have the *CC* field set to 0, which is implied by the first format in the “Format” section.

The MIPS IV and MIPS32 architectures add seven more *Condition Code* bits to the original condition code 0. FP compare and conditional branch instructions specify the *Condition Code* bit to set or test. Both assembler formats are valid for MIPS IV and MIPS32.

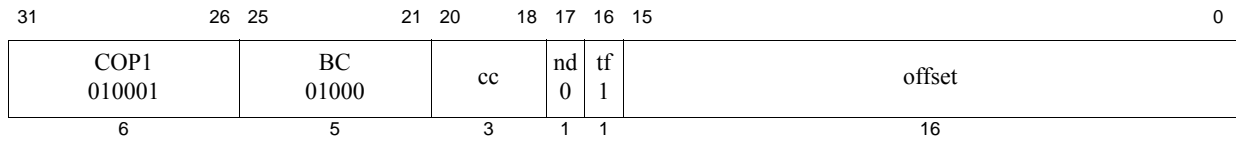

Format: BC1T offset (cc = 0 implied)
BC1T cc, offset

MIPS32, removed in Release 6
MIPS32, removed in Release 6

Purpose: Branch on FP True

To test an FP condition code and do a PC-relative conditional branch.

Description: if FPConditionCode(cc) = 1 then branch

An 18-bit signed offset (the 16-bit *offset* field shifted left 2 bits) is added to the address of the instruction following the branch (not the branch itself) in the branch delay slot to form a PC-relative effective target address. If the FP condition code bit *cc* is true (1), the program branches to the effective target address after the instruction in the delay slot is executed. An FP condition code is set by the FP compare instruction, C.cond.fmt.

Restrictions:

Processor operation is **UNPREDICTABLE** if a control transfer instruction (CTI) is placed in the delay slot of a branch or jump.

Availability and Compatibility:

This instruction has been removed in Release 6.

Operation:

```
I:   condition ← FPConditionCode(cc) = 1
      target_offset ← (offset15)GPRLLEN-(16+2) || offset || 02
I+1: if condition then
      PC ← PC + target_offset
      endif
```

Exceptions:

Coprocessor Unusable, Reserved Instruction

Floating Point Exceptions:

Unimplemented Operation

Programming Notes:

With the 18-bit signed instruction offset, the conditional branch range is ± 128 KBytes. Use jump (J) or jump register (JR) to branch to addresses outside this range.

This instruction has been replaced by the BC1NEZ instruction. Refer to the ‘BC1NEZ’ instruction in this manual for more information.

Historical Information:

The MIPS I architecture defines a single floating point condition code, implemented as the coprocessor 1 condition signal (*Cp1Cond*) and the *C* bit in the FP *Control/Status* register. MIPS I, II, and III architectures must have the *CC* field set to 0, which is implied by the first format in the “Format” section.

The MIPS IV and MIPS32 architectures add seven more *Condition Code* bits to the original condition code 0. FP compare and conditional branch instructions specify the *Condition Code* bit to set or test. Both assembler formats are valid for MIPS IV and MIPS32.

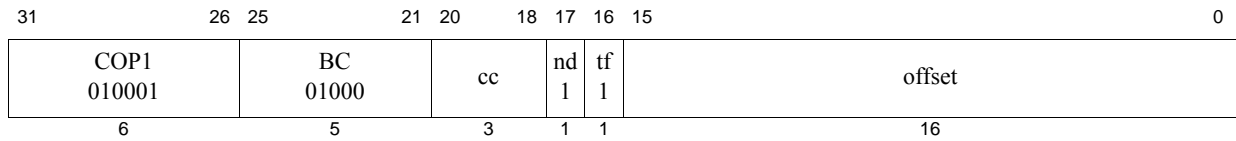

Format: BC1TL offset (cc = 0 implied)
BC1TL cc, offset

MIPS32, removed in Release 6
MIPS32, removed in Release 6

Purpose: Branch on FP True Likely

To test an FP condition code and do a PC-relative conditional branch; execute the instruction in the delay slot only if the branch is taken.

Description: if $\text{FPConditionCode}(cc) = 1$ then branch_likely

An 18-bit signed offset (the 16-bit *offset* field shifted left 2 bits) is added to the address of the instruction following the branch (not the branch itself) in the branch delay slot to form a PC-relative effective target address. If the FP *Condition Code* bit *cc* is true (1), the program branches to the effective target address after the instruction in the delay slot is executed. If the branch is not taken, the instruction in the delay slot is not executed.

An FP condition code is set by the FP compare instruction, C.cond.fmt.

Restrictions:

Processor operation is **UNPREDICTABLE** if a branch, jump, ERET, DERET, or WAIT instruction is placed in the delay slot of a branch or jump.

Availability and Compatibility:

This instruction has been removed in Release 6.

Operation:

This operation specification is for the general Branch On Condition operation with the *tf* (true/false) and *nd* (nullify delay slot) fields as variables. The individual instructions BC1F, BC1FL, BC1T, and BC1TL have specific values for *tf* and *nd*.

```
I:   condition ← FPConditionCode(cc) = 1
      target_offset ← (offset15)GPRELEN-(16+2) || offset || 02
I+1: if condition then
      PC ← PC + target_offset
      else
      NullifyCurrentInstruction()
      endif
```

Exceptions:

Coprocessor Unusable, Reserved Instruction

Floating Point Exceptions:

Unimplemented Operation

Implementation Note:

Some implementations always predict that the branch will be taken, and do not use nor do they update the branch internal processor branch prediction tables for this instruction. To maintain performance compatibility, future implementations are encouraged to do the same.

Programming Notes:

With the 18-bit signed instruction offset, the conditional branch range is ± 128 KBytes. Use jump (J) or jump register (JR) to branch to addresses outside this range.

In Pre-Release 6 implementations, software is strongly encouraged to avoid the use of the Branch Likely instructions, as they will be removed from a future revision of the MIPS Architecture.

Some implementations always predict the branch will be taken, so there is a significant penalty if the branch is not taken. Software should only use this instruction when there is a very high probability (98% or more) that the branch will be taken. If the branch is not likely to be taken or if the probability of a taken branch is unknown, software is encouraged to use the BC1T instruction instead.

Historical Information:

The MIPS I architecture defines a single floating point condition code, implemented as the coprocessor 1 condition signal (*Cp1Cond*) and the *C* bit in the FP *Control/Status* register. MIPS I, II, and III architectures must have the *CC* field set to 0, which is implied by the first format in the “Format” section.

The MIPS IV and MIPS32 architectures add seven more *Condition Code* bits to the original condition code 0. FP compare and conditional branch instructions specify the *Condition Code* bit to set or test. Both assembler formats are valid for MIPS IV and MIPS32.

31	26 25	21 20	16 15	0
COP2 010010	BC2EQZ 01001	ct	offset	
COP2 010010	BC2NEZ 01101	ct	offset	
6	5	5	16	

Format: BC2EQZ BC2NEZ
 BC2EQZ ct, offset
 BC2NEZ ct, offset

MIPS32 Release 6
 MIPS32 Release 6

Purpose: Branch if Coprocessor 2 Condition (Register) Equal/Not Equal to Zero

BC2EQZ: Branch if Coprocessor 2 Condition (Register) is Equal to Zero

BC2NEZ: Branch if Coprocessor 2 Condition (Register) is Not Equal to Zero

Description:

BC2EQZ: if COP2Condition[ct] = 0 then branch
 BC2NEZ: if COP2Condition[ct] ≠ 0 then branch

The 5-bit field *ct* specifies a coprocessor 2 condition.

- For BC2EQZ if the coprocessor 2 condition is true the branch is taken.
- For BC2NEZ if the coprocessor 2 condition is false the branch is taken.

A 18-bit signed offset (the 16-bit offset field shifted left 2 bits) is added to the address of the instruction following the branch (not the branch itself), to form a PC-relative effective target address. Execute the instruction in the delay slot before the instruction at the target.

Restrictions:

Control Transfer Instructions (CTIs) should not be placed in branch delay slots or Release 6 forbidden slots. CTIs include all branches and jumps, NAL, ERET, ERETNC, DERET, WAIT, and PAUSE.

If a control transfer instruction (CTI) is executed in the delay slot of a branch or jump, Release 6 implementations are required to signal a Reserved Instruction exception.

If access to Coprocessor 2 is not enabled, a Coprocessor Unusable Exception is signaled.

Availability and Compatibility:

These instructions are introduced by and required as of Release 6.

Exceptions:

Coprocessor Unusable, Reserved Instruction

Operation:

```

tmpcond ← Coprocessor2Condition(ct)
if BC2EQZ then
  tmpcond ← not(tmpcond)
endif

if tmpcond then
  PC ← PC+4 + sign_extend( immediate << 2 )
endif

```

Implementation Notes:

As of Release 6 these instructions, BC2EQZ and BC2NEZ, replace the pre-Release 6 instructions BC2F and BC2T, which had a 3-bit condition code field (as well as nullify and true/false bits). Release 6 makes all 5 bits of the `cc` condition code available to the coprocessor designer as a condition specifier.

A customer defined coprocessor instruction set can implement any sort of condition it wants. For example, it could implement up to 32 single-bit flags, specified by the 5-bit field `cc`. It could also implement conditions encoded as values in a coprocessor register (such as testing the least significant bit of a coprocessor register) as done by Release 6 instructions BC1EQZ/BC1NEZ.

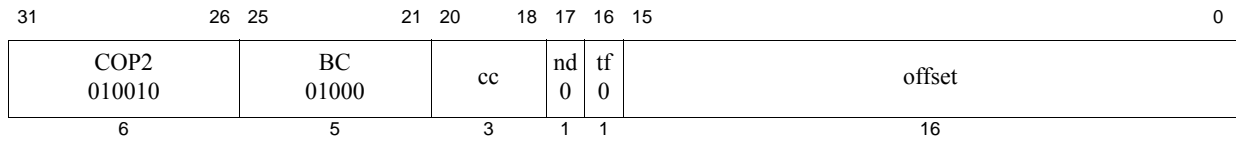

Format: BC2F offset (cc = 0 implied)
BC2F cc, offset

MIPS32, removed in Release 6
MIPS32, removed in Release 6

Purpose: Branch on COP2 False

To test a COP2 condition code and do a PC-relative conditional branch.

Description: if COP2Condition(cc) = 0 then branch

An 18-bit signed offset (the 16-bit *offset* field shifted left 2 bits) is added to the address of the instruction following the branch (not the branch itself) in the branch delay slot to form a PC-relative effective target address. If the COP2 condition specified by *cc* is false (0), the program branches to the effective target address after the instruction in the delay slot is executed.

Restrictions:

Processor operation is **UNPREDICTABLE** if a control transfer instruction (CTI) is placed in the delay slot of a branch or jump.

Availability and Compatibility:

This instruction has been removed in Release 6.

Operation:

```

I:    condition ← COP2Condition(cc) = 0
        target_offset ← (offset15)GPRLEN-(16+2) || offset || 02
I+1:  if condition then
        PC ← PC + target_offset
        endif

```

Exceptions:

Coprocessor Unusable, Reserved Instruction

Programming Notes:

With the 18-bit signed instruction offset, the conditional branch range is ± 128 KBytes. Use jump (J) or jump register (JR) to branch to addresses outside this range.

This instruction has been replaced by the BC2EQZ instruction. Refer to the 'BC2EQZ' instruction in this manual for more information.

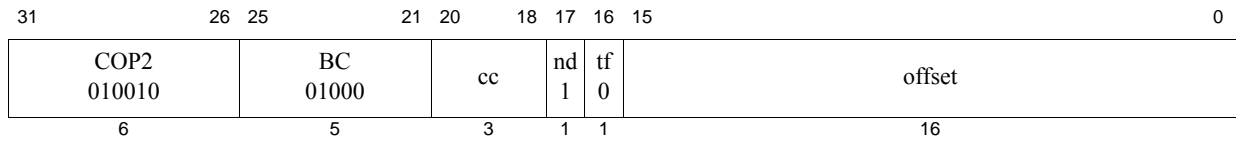

Format: BC2FL offset (cc = 0 implied)
BC2FL cc, offset

MIPS32, removed in Release 6
MIPS32, removed in Release 6

Purpose: Branch on COP2 False Likely

To test a COP2 condition code and make a PC-relative conditional branch; execute the instruction in the delay slot only if the branch is taken.

Description: if COP2Condition(cc) = 0 then branch_likely

An 18-bit signed offset (the 16-bit *offset* field shifted left 2 bits) is added to the address of the instruction following the branch (not the branch itself) in the branch delay slot to form a PC-relative effective target address. If the COP2 condition specified by *cc* is false (0), the program branches to the effective target address after the instruction in the delay slot is executed. If the branch is not taken, the instruction in the delay slot is not executed.

Restrictions:

Processor operation is **UNPREDICTABLE** if a branch, jump, ERET, DERET, or WAIT instruction is placed in the delay slot of a branch or jump.

Availability and Compatibility:

This instruction has been removed in Release 6.

Operation:

This operation specification is for the general Branch On Condition operation with the *tf* (true/false) and *nd* (nullify delay slot) fields as variables. The individual instructions BC2F, BC2FL, BC2T, and BC2TL have specific values for *tf* and *nd*.

```

I:    condition ← COP2Condition(cc) = 0
        target_offset ← (offset15)GPRLLEN-(16+2) || offset || 02
I+1:  if condition then
        PC ← PC + target_offset
        else
        NullifyCurrentInstruction()
        endif

```

Exceptions:

Coprocessor Unusable, Reserved Instruction

Implementation Note:

Some implementations always predict that the branch will be taken, and do not use nor do they update the branch internal processor branch prediction tables for this instruction. To maintain performance compatibility, future implementations are encouraged to do the same.

Programming Notes:

With the 18-bit signed instruction offset, the conditional branch range is ± 128 KBytes. Use jump (J) or jump register (JR) to branch to addresses outside this range.

In Pre-Release 6 implementations, software is strongly encouraged to avoid the use of the Branch Likely instructions,

as they will be removed from a future revision of the MIPS Architecture.

Some implementations always predict the branch will be taken, so there is a significant penalty if the branch is not taken. Software should only use this instruction when there is a very high probability (98% or more) that the branch will be taken. If the branch is not likely to be taken or if the probability of a taken branch is unknown, software is encouraged to use the BC2F instruction instead.

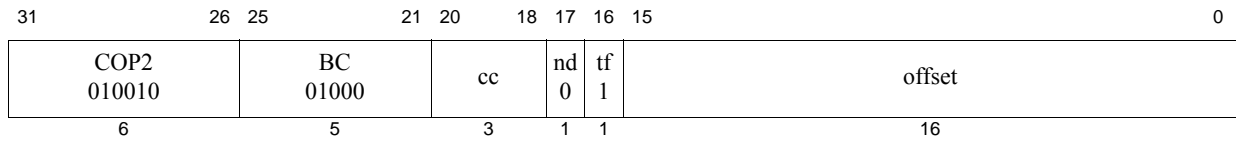

Format: BC2T offset (cc = 0 implied)
BC2T cc, offset

MIPS32, removed in Release 6
MIPS32, removed in Release 6

Purpose: Branch on COP2 True

To test a COP2 condition code and do a PC-relative conditional branch.

Description: if COP2Condition(cc) = 1 then branch

An 18-bit signed offset (the 16-bit *offset* field shifted left 2 bits) is added to the address of the instruction following the branch (not the branch itself) in the branch delay slot to form a PC-relative effective target address. If the COP2 condition specified by *cc* is true (1), the program branches to the effective target address after the instruction in the delay slot is executed.

Restrictions:

Processor operation is **UNPREDICTABLE** if a control transfer instruction (CTI) is placed in the delay slot of a branch or jump.

Availability and Compatibility:

This instruction has been removed in Release 6.

Operation:

```

I:    condition ← COP2Condition(cc) = 1
        target_offset ← (offset15)GPRLEN-(16+2) || offset || 02
I+1:  if condition then
        PC ← PC + target_offset
        endif

```

Exceptions:

Coprocessor Unusable, Reserved Instruction

Programming Notes:

With the 18-bit signed instruction offset, the conditional branch range is ± 128 KBytes. Use jump (J) or jump register (JR) to branch to addresses outside this range.

This instruction has been replaced by the BC2NEZ instruction. Refer to the 'BC2NEZ' instruction in this manual for more information.

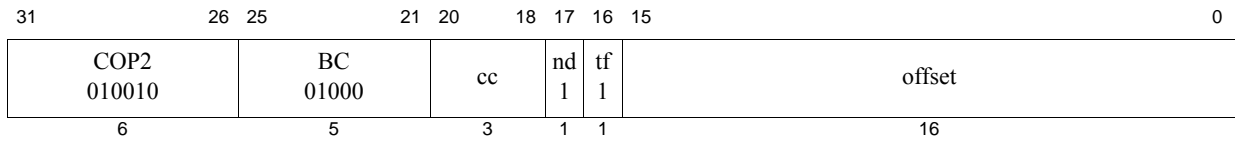

Format: BC2TL offset (cc = 0 implied)
BC2TL cc, offset

MIPS32, removed in Release 6
MIPS32, removed in Release 6

Purpose: Branch on COP2 True Likely

To test a COP2 condition code and do a PC-relative conditional branch; execute the instruction in the delay slot only if the branch is taken.

Description: if COP2Condition(cc) = 1 then branch_likely

An 18-bit signed offset (the 16-bit *offset* field shifted left 2 bits) is added to the address of the instruction following the branch (not the branch itself) in the branch delay slot to form a PC-relative effective target address. If the COP2 condition specified by *cc* is true (1), the program branches to the effective target address after the instruction in the delay slot is executed. If the branch is not taken, the instruction in the delay slot is not executed.

Restrictions:

Processor operation is **UNPREDICTABLE** if a branch, jump, ERET, DERET, or WAIT instruction is placed in the delay slot of a branch or jump.

Availability and Compatibility:

This instruction has been removed in Release 6.

Operation:

This operation specification is for the general Branch On Condition operation with the *tf* (true/false) and *nd* (nullify delay slot) fields as variables. The individual instructions BC2F, BC2FL, BC2T, and BC2TL have specific values for *tf* and *nd*.

```

I:    condition ← COP2Condition(cc) = 1
        target_offset ← (offset15)GPRLLEN-(16+2) || offset || 02
I+1:  if condition then
        PC ← PC + target_offset
        else
        NullifyCurrentInstruction()
        endif

```

Exceptions:

Coprocessor Unusable, Reserved Instruction

Implementation Note:

Some implementations always predict that the branch will be taken, and do not use nor do they update the branch internal processor branch prediction tables for this instruction. To maintain performance compatibility, future implementations are encouraged to do the same.

Programming Notes:

With the 18-bit signed instruction offset, the conditional branch range is ± 128 KBytes. Use jump (J) or jump register (JR) to branch to addresses outside this range.

In Pre-Release 6 implementations, software is strongly encouraged to avoid the use of the Branch Likely instructions,

as they will be removed from a future revision of the MIPS Architecture.

Some implementations always predict the branch will be taken, so there is a significant penalty if the branch is not taken. Software should only use this instruction when there is a very high probability (98% or more) that the branch will be taken. If the branch is not likely to be taken or if the probability of a taken branch is unknown, software is encouraged to use the BC2T instruction instead.

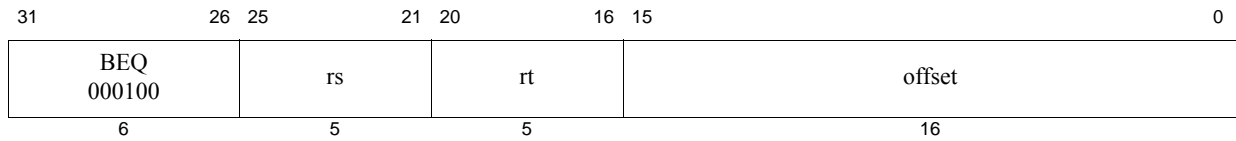

Format: BEQ *rs*, *rt*, *offset*

MIPS32

Purpose: Branch on Equal

To compare GPRs then do a PC-relative conditional branch.

Description: if $GPR[rs] = GPR[rt]$ then branch

An 18-bit signed offset (the 16-bit *offset* field shifted left 2 bits) is added to the address of the instruction following the branch (not the branch itself), in the branch delay slot, to form a PC-relative effective target address.

If the contents of GPR *rs* and GPR *rt* are equal, branch to the effective target address after the instruction in the delay slot is executed.

Restrictions:

Control Transfer Instructions (CTIs) should not be placed in branch delay slots or Release 6 forbidden slots. CTIs include all branches and jumps, NAL, ERET, ERETNC, DERET, WAIT, and PAUSE.

Pre-Release 6: Processor operation is **UNPREDICTABLE** if a control transfer instruction (CTI) is placed in the delay slot of a branch or jump.

Release 6: If a control transfer instruction (CTI) is executed in the delay slot of a branch or jump, Release 6 implementations are required to signal a Reserved Instruction exception.

Operation:

```

I:   target_offset ← sign_extend(offset || 02)
      condition ← (GPR[rs] = GPR[rt])
I+1: if condition then
      PC ← PC + target_offset
      endif

```

Exceptions:

None

Programming Notes:

With the 18-bit signed instruction offset, the conditional branch range is ± 128 KBytes. Use jump (J) or jump register (JR) to branch to addresses outside this range.

BEQ *r0*, *r0* *offset*, expressed as B *offset*, is the assembly idiom used to denote an unconditional branch.

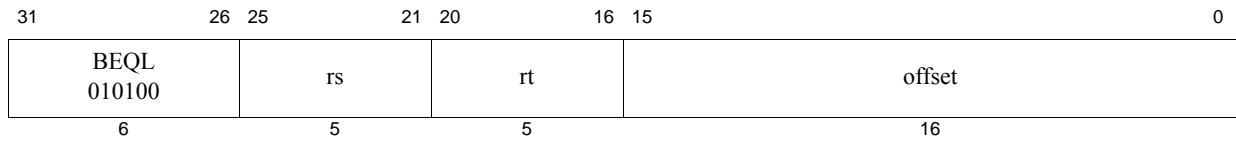

Format: BEQL *rs*, *rt*, *offset*

MIPS32, removed in Release 6

Purpose: Branch on Equal Likely

To compare GPRs then do a PC-relative conditional branch; execute the delay slot only if the branch is taken.

Description: if $GPR[rs] = GPR[rt]$ then *branch_likely*

An 18-bit signed offset (the 16-bit *offset* field shifted left 2 bits) is added to the address of the instruction following the branch (not the branch itself), in the branch delay slot, to form a PC-relative effective target address.

If the contents of GPR *rs* and GPR *rt* are equal, branch to the target address after the instruction in the delay slot is executed. If the branch is not taken, the instruction in the delay slot is not executed.

Restrictions:

Processor operation is **UNPREDICTABLE** if a branch, jump, ERET, DERET, or WAIT instruction is placed in the delay slot of a branch or jump.

Availability and Compatibility:

This instruction has been removed in Release 6.

Operation:

```

I:   target_offset ← sign_extend(offset || 02)
      condition ← (GPR[rs] = GPR[rt])
I+1: if condition then
      PC ← PC + target_offset
      else
      NullifyCurrentInstruction()
      endif

```

Exceptions:

None

Implementation Note:

Some implementations always predict that the branch will be taken, and do not use nor do they update the branch internal processor branch prediction tables for this instruction. To maintain performance compatibility, future implementations are encouraged to do the same.

Programming Notes:

With the 18-bit signed instruction offset, the conditional branch range is ± 128 KBytes. Use jump (J) or jump register (JR) to branch to addresses outside this range.

In Pre-Release 6 implementations, software is strongly encouraged to avoid the use of the Branch Likely instructions, as they will be removed from a future revision of the MIPS Architecture.

Some implementations always predict the branch will be taken, so there is a significant penalty if the branch is not taken. Software should only use this instruction when there is a very high probability (98% or more) that the branch will be taken. If the branch is not likely to be taken or if the probability of a taken branch is unknown, software is encouraged to use the BEQ instruction instead.

Historical Information:

In the MIPS I architecture, this instruction signaled a Reserved Instruction exception.

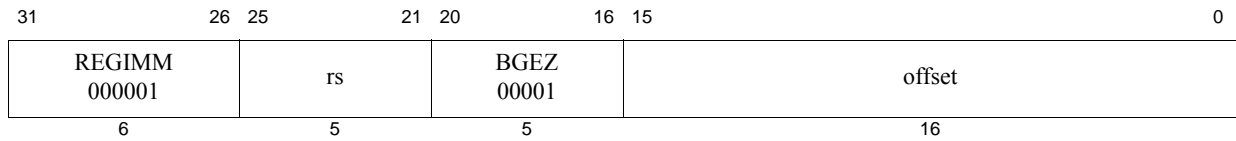

Format: BGEZ *rs*, *offset*

MIPS32

Purpose: Branch on Greater Than or Equal to Zero

To test a GPR then do a PC-relative conditional branch

Description: if $GPR[rs] \geq 0$ then branch

An 18-bit signed offset (the 16-bit *offset* field shifted left 2 bits) is added to the address of the instruction following the branch (not the branch itself), in the branch delay slot, to form a PC-relative effective target address.

If the contents of GPR *rs* are greater than or equal to zero (sign bit is 0), branch to the effective target address after the instruction in the delay slot is executed.

Restrictions:

Control Transfer Instructions (CTIs) should not be placed in branch delay slots or Release 6 forbidden slots. CTIs include all branches and jumps, NAL, ERET, ERETNC, DERET, WAIT, and PAUSE.

Pre-Release 6: Processor operation is **UNPREDICTABLE** if a control transfer instruction (CTI) is placed in the delay slot of a branch or jump.

Release 6: If a control transfer instruction (CTI) is executed in the delay slot of a branch or jump, Release 6 implementations are required to signal a Reserved Instruction exception.

Operation:

```

I:   target_offset ← sign_extend(offset || 02)
      condition ← GPR[rs] ≥ 0GPRLEN
I+1: if condition then
      PC ← PC + target_offset
      endif

```

Exceptions:

None

Programming Notes:

With the 18-bit signed instruction offset, the conditional branch range is ± 128 KBytes. Use jump (J) or jump register (JR) to branch to addresses outside this range.

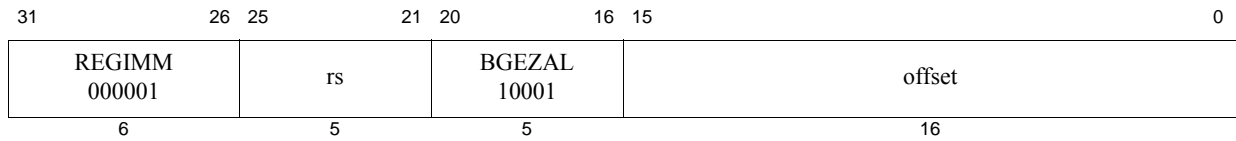

Format: BGEZAL *rs*, *offset*

MIPS32, removed in Release 6

Purpose: Branch on Greater Than or Equal to Zero and Link

To test a GPR then do a PC-relative conditional procedure call

Description: if $GPR[rs] \geq 0$ then *procedure_call*

Place the return address link in GPR 31. The return link is the address of the second instruction following the branch, where execution continues after a procedure call.

An 18-bit signed offset (the 16-bit *offset* field shifted left 2 bits) is added to the address of the instruction following the branch (not the branch itself), in the branch delay slot, to form a PC-relative effective target address.

If the contents of GPR *rs* are greater than or equal to zero (sign bit is 0), branch to the effective target address after the instruction in the delay slot is executed.

Availability and Compatibility

This instruction has been removed in Release 6 with the exception of special case BAL (unconditional Branch and Link) which was an alias for BGEZAL with $rs=0$.

Restrictions:

Processor operation is **UNPREDICTABLE** if a control transfer instruction (CTI) is placed in the delay slot of a branch or jump.

Branch-and-link Restartability: GPR 31 must not be used for the source register *rs*, because such an instruction does not have the same effect when reexecuted. The result of executing such an instruction is **UNPREDICTABLE**. This restriction permits an exception handler to resume execution by reexecuting the branch when an exception occurs in the branch delay slot or forbidden slot.

Operation:

```

I:    target_offset ← sign_extend(offset || 02)
        condition ←  $GPR[rs] \geq 0^{GPRLEN}$ 
        GPR[31] ← PC + 8
I+1:  if condition then
        PC ← PC + target_offset
        endif

```

Exceptions:

None

Programming Notes:

With the 18-bit signed instruction offset, the conditional branch range is ± 128 KBytes. Use jump and link (JAL) or jump and link register (JALR) instructions for procedure calls to addresses outside this range.

BGEZAL *r0*, *offset*, expressed as BAL *offset*, is the assembly idiom used to denote a PC-relative branch and link. BAL is used in a manner similar to JAL, but provides PC-relative addressing and a more limited target PC range.

31	26 25	21 20	16 15	0
POP06 000110	BLEZALC 00000	rt ≠ 00000	offset	
POP06 000110	BGEZALC rs = rt ≠ 00000	rs rt	offset	
POP07 000111	BGTZALC 00000	rt ≠ 00000	offset	
POP07 000111	BLTZALC rs = rt ≠ 00000	rs rt	offset	
POP10 001000	BEQZALC rs < rt	00000 rt ≠ 00000	offset	
POP30 011000	BNEZALC rs < rt	00000 rt ≠ 00000	offset	
6	5	5	16	

Format: B{LE, GE, GT, LT, EQ, NE}ZALC
 BLEZALC rt, offset
 BGEZALC rt, offset
 BGTZALC rt, offset
 BLTZALC rt, offset
 BEQZALC rt, offset
 BNEZALC rt, offset

MIPS32 Release 6
 MIPS32 Release 6
 MIPS32 Release 6
 MIPS32 Release 6
 MIPS32 Release 6
 MIPS32 Release 6

Purpose: Compact Zero-Compare and Branch-and-Link Instructions

BLEZALC: Compact branch-and-link if GPR *rt* is less than or equal to zero

BGEZALC: Compact branch-and-link if GPR *rt* is greater than or equal to zero

BGTZALC: Compact branch-and-link if GPR *rt* is greater than zero

BLTZALC: Compact branch-and-link if GPR *rt* is less than to zero

BEQZALC: Compact branch-and-link if GPR *rt* is equal to zero

BNEZALC: Compact branch-and-link if GPR *rt* is not equal to zero

Description: if condition(GPR[*rt*]) then procedure_call branch (no delay slot)

The condition is evaluated. If the condition is true, the branch is taken.

Places the return address link in GPR 31. The return link is the address of the instruction immediately following the branch, where execution continues after a procedure call.

The return address link is unconditionally updated.

A 18-bit signed offset (the 16-bit offset field shifted left 2 bits) is added to the address of the instruction following the branch (not the branch itself), to form a PC-relative effective target address.

BLEZALC: the condition is true if and only if GPR rt is less than or equal to zero.
 BGEZALC: the condition is true if and only if GPR rt is greater than or equal to zero.
 BLTZALC: the condition is true if and only if GPR rt is less than zero.
 BGTZALC: the condition is true if and only if GPR rt is greater than zero.
 BEQZALC: the condition is true if and only if GPR rt is equal to zero.
 BNEZALC: the condition is true if and only if GPR rt is not equal to zero.

Compact branches do not have delay slots. The instruction after a compact branch is only executed if the branch is not taken.

Restrictions:

Control Transfer Instructions (CTIs) should not be placed in branch delay slots or Release 6 forbidden slots. CTIs include all branches and jumps, NAL, ERET, ERETNC, DERET, WAIT, and PAUSE.

If a control transfer instruction (CTI) is executed in the forbidden slot of a compact branch, Release 6 implementations are required to signal a Reserved Instruction exception, but only when the branch is not taken.

Branch-and-link Restartability: GPR 31 must not be used for the source registers, because such an instruction does not have the same effect when reexecuted. The result of executing such an instruction is **UNPREDICTABLE**. This restriction permits an exception handler to resume execution by reexecuting the branch when an exception occurs in the branch delay slot or forbidden slot.

Availability and Compatibility:

These instructions are introduced by and required as of Release 6.

- BEQZALC reuses the opcode assigned to pre-Release 6 ADDI.
- BNEZALC reuses the opcode assigned to pre-Release 6 MIPS64 DADDI.

These instructions occupy primary opcode spaces originally allocated to other instructions. BLEZALC and BGEZALC have the same primary opcode as BLEZ, and are distinguished by rs and rt register numbers. Similarly, BGTZALC and BLTZALC have the same primary opcode as BGTZ, and are distinguished by register fields. BEQZALC and BNEZALC reuse the primary opcodes ADDI and DADDI.

Exceptions:

None

Operation:

```
GPR[31] ← PC+4
target_offset ← sign_extend( offset || 02 )

BLTZALC: cond ← GPR[rt] < 0
BLEZALC: cond ← GPR[rt] ≤ 0
BGEZALC: cond ← GPR[rt] ≥ 0
BGTZALC: cond ← GPR[rt] > 0
BEQZALC: cond ← GPR[rt] = 0
BNEZALC: cond ← GPR[rt] ≠ 0

if cond then
  PC ← ( PC+4+ sign_extend( target_offset ) )
endif
```

Programming Notes:

Software that performs incomplete instruction decode may incorrectly decode these new instructions, because of their

very tight encoding. For example, a disassembler might look only at the primary opcode field, instruction bits 31-26, to decode BLEZL without checking that the “rt” field is zero. Such software violated the pre-Release 6 architecture specification.

With the 16-bit offset shifted left 2 bits and sign extended, the conditional branch range is ± 128 KBytes. Other instructions such as pre-Release 6 JAL and JALR, or Release 6 JIALC and BALC have larger ranges. In particular, BALC, with a 26-bit offset shifted by 2 bits, has a 28-bit range, ± 128 MBytes. Code sequences using AUIPC and JIALC allow still greater PC-relative range.

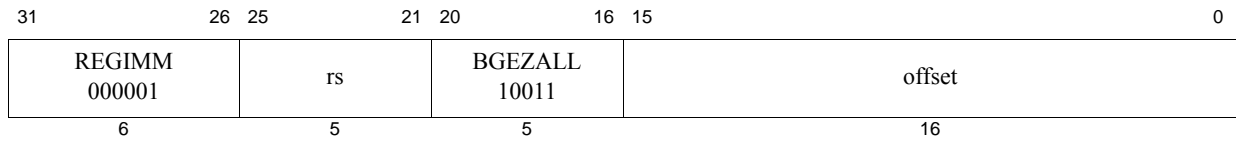

Format: BGEZALL *rs*, *offset*

MIPS32, removed in Release 6

Purpose: Branch on Greater Than or Equal to Zero and Link Likely

To test a GPR then do a PC-relative conditional procedure call; execute the delay slot only if the branch is taken.

Description: if $GPR[rs] \geq 0$ then `procedure_call_likely`

Place the return address link in GPR 31. The return link is the address of the second instruction following the branch, where execution continues after a procedure call.

An 18-bit signed offset (the 16-bit *offset* field shifted left 2 bits) is added to the address of the instruction following the branch (not the branch itself), in the branch delay slot, to form a PC-relative effective target address.

If the contents of GPR *rs* are greater than or equal to zero (sign bit is 0), branch to the effective target address after the instruction in the delay slot is executed. If the branch is not taken, the instruction in the delay slot is not executed.

Restrictions:

Processor operation is **UNPREDICTABLE** if a control transfer instruction (CTI) is placed in the delay slot of a branch or jump.

Branch-and-link Restartability: GPR 31 must not be used for the source register *rs*, because such an instruction does not have the same effect when reexecuted. The result of executing such an instruction is **UNPREDICTABLE**. This restriction permits an exception handler to resume execution by reexecuting the branch when an exception occurs in the branch delay slot.

Availability and Compatibility:

This instruction has been removed in Release 6.

Operation:

```

I:   target_offset ← sign_extend(offset || 02)
        condition ← GPR[rs] ≥ 0GPRLEN
        GPR[31] ← PC + 8
I+1: if condition then
        PC ← PC + target_offset
        else
        NullifyCurrentInstruction()
        endif

```

Exceptions:

None

Programming Notes:

With the 18-bit signed instruction offset, the conditional branch range is ± 128 KBytes. Use jump and link (JAL) or jump and link register (JALR) instructions for procedure calls to addresses outside this range.

Some implementations always predict the branch will be taken, so there is a significant penalty if the branch is not taken. Software should only use this instruction when there is a very high probability (98% or more) that the branch will be taken. If the branch is not likely to be taken or if the probability of a taken branch is unknown, software is

encouraged to use the BGEZAL instruction instead.

Historical Information:

In the MIPS I architecture, this instruction signaled a Reserved Instruction exception.

31	26	25	21	20	16	15	0
POP26 010110	BLEZC		00000	rt ≠ 00000	offset		
POP26 010110	BGEZC rs = rt		rs ≠ 00000	rt ≠ 00000	offset		
POP26 010110	BGEC (BLEC) rs ≠ rt		rs ≠ 00000	rt ≠ 00000	offset		
POP27 010111	BGTZC		00000	rt ≠ 00000	offset		
POP27 010111	BLTZC rs = rt		rs ≠ 00000	rt ≠ 00000	offset		
POP27 010111	BLTC (BGTC) rs ≠ rt		rs ≠ 00000	rt ≠ 00000	offset		
POP06 000110	BGEUC (BLEUC) rs ≠ rt		rs ≠ 00000	rt ≠ 00000	offset		
POP07 000111	BLTUC (BGTUC) rs ≠ rt		rs ≠ 00000	rt ≠ 00000	offset		
POP10 001000	BEQC rs < rt		rs ≠ 00000	rt ≠ 00000	offset		
POP30 011000	BNEC rs < rt		rs ≠ 00000	rt ≠ 00000	offset		
6	5	5	16				

31	26	25	21	20	16	15	0
POP66 110110	BEQZC		rs ≠ 00000	rs	offset		
POP76 111110	BNEZC		rs ≠ 00000	rs	offset		
6	5	21					

Format: B<cond>C rs, rt, offset

MIPS32 Release 6

Purpose: Compact Compare-and-Branch Instructions

Format Details:

Equal/Not-Equal register-register compare and branch with 16-bit offset:

BEQC rs, rt, offset

MIPS32 Release 6

BNEC rs, rt, offset

MIPS32 Release 6

Signed register-register compare and branch with 16-bit offset:

BLTC *rs*, *rt*, *offset*
BGEC *rs*, *rt*, *offset*

MIPS32 Release 6

MIPS32 Release 6

Unsigned register-register compare and branch with 16-bit offset:

BLTUC *rs*, *rt*, *offset*
BGEUC *rs*, *rt*, *offset*

MIPS32 Release 6

MIPS32 Release 6

Assembly idioms with reversed operands for signed/unsigned compare-and-branch:

BGTC *rt*, *rs*, *offset*
BLEC *rt*, *rs*, *offset*
BGTUC *rt*, *rs*, *offset*
BLEUC *rt*, *rs*, *offset*

Assembly Idiom

Assembly Idiom

Assembly Idiom

Assembly Idiom

Signed Compare register to Zero and branch with 16-bit offset:

BLTZC *rt*, *offset*
BLEZC *rt*, *offset*
BGEZC *rt*, *offset*
BGTZC *rt*, *offset*

MIPS32 Release 6

MIPS32 Release 6

MIPS32 Release 6

MIPS32 Release 6

Equal/Not-equal Compare register to Zero and branch with 21-bit offset:

BEQZC *rs*, *offset*
BNEZC *rs*, *offset*

MIPS32 Release 6

MIPS32 Release 6

Description: if condition(GPR[*rs*] and/or GPR[*rt*]) then compact branch (no delay slot)

The condition is evaluated. If the condition is true, the branch is taken.

An 18/23-bit signed offset (the 16/21-bit offset field shifted left 2 bits) is added to the address of the instruction following the branch (not the branch itself), to form a PC-relative effective target address.

The offset is 16 bits for most compact branches, including BLTC, BLEC, BGEC, BGTC, BNEQC, BNEC, BLTUC, BLEUC, BGEUC, BGTC, BLTZC, BLEZC, BGEZC, BGTZC. The offset is 21 bits for BEQZC and BNEZC.

Compact branches have no delay slot: the instruction after the branch is NOT executed if the branch is taken.

The conditions are as follows:

Equal/Not-equal register-register compare-and-branch with 16-bit offset:

BEQC: Compact branch if GPRs are equal
BNEC: Compact branch if GPRs are not equal

Signed register-register compare and branch with 16-bit offset:

BLTC: Compact branch if GPR *rs* is less than GPR *rt*
BGEC: Compact branch if GPR *rs* is greater than or equal to GPR *rt*

Unsigned register-register compare and branch with 16-bit offset:

BLTUC: Compact branch if GPR *rs* is less than GPR *rt*, unsigned
BGEUC: Compact branch if GPR *rs* is greater than or equal to GPR *rt*, unsigned

Assembly Idioms with Operands Reversed:

BLEC: Compact branch if GPR *rt* is less than or equal to GPR *rs* (alias for BGEC)
BGTC: Compact branch if GPR *rt* is greater than GPR *rs* (alias for BLTC)
BLEUC: Compact branch if GPR *rt* is less than or equal to GPR *rt*, unsigned (alias for BGEUC)
BGTUC: Compact branch if GPR *rt* is greater than GPR *rs*, unsigned (alias for BLTUC)

Compare register to zero and branch with 16-bit offset:

- BLTZC: Compact branch if GPR *rt* is less than zero
- BLEZC: Compact branch if GPR *rt* is less than or equal to zero
- BGEZC: Compact branch if GPR *rt* is greater than or equal to zero
- BGTZC: Compact branch if GPR *rt* is greater than zero

Compare register to zero and branch with 21-bit offset:

- BEQZC: Compact branch if GPR *rs* is equal to zero
- BNEZC: Compact branch if GPR *rs* is not equal to zero

Restrictions:

Control Transfer Instructions (CTIs) should not be placed in branch delay slots or Release 6 forbidden slots. CTIs include all branches and jumps, NAL, ERET, ERETNC, DERET, WAIT, and PAUSE.

If a control transfer instruction (CTI) is placed in the forbidden slot of a compact branch, Release 6 implementations are required to signal a Reserved Instruction exception, but only when the branch is not taken.

Availability and Compatibility:

These instructions are introduced by and required as of Release 6.

- BEQZC reuses the opcode assigned to pre-Release 6 LDC2.
- BNEZC reuses the opcode assigned to pre-Release 6 SDC2.
- BEQC reuses the opcode assigned to pre-Release 6 ADDI.
- BNEC reuses the opcode assigned to pre-Release 6 MIPD64 DADDI.

Exceptions:

None

Operation:

```
target_offset ← sign_extend( offset || 02 )

/* Register-register compare and branch, 16 bit offset: */
/* Equal / Not-Equal */
BEQC: cond ← GPR[rs] = GPR[rt]
BNEC: cond ← GPR[rs] ≠ GPR[rt]
/* Signed */
BLTC: cond ← GPR[rs] < GPR[rt]
BGEC: cond ← GPR[rs] ≥ GPR[rt]
/* Unsigned: */
BLTUC: cond ← unsigned(GPR[rs]) < unsigned(GPR[rt])
BGEUC: cond ← unsigned(GPR[rs]) ≥ unsigned(GPR[rt])

/* Compare register to zero, small offset: */
BLTZC: cond ← GPR[rt] < 0
BLEZC: cond ← GPR[rt] ≤ 0
BGEZC: cond ← GPR[rt] ≥ 0
BGTZC: cond ← GPR[rt] > 0
/* Compare register to zero, large offset: */
BEQZC: cond ← GPR[rs] = 0
BNEZC: cond ← GPR[rs] ≠ 0

if cond then
    PC ← ( PC+4+ sign_extend( offset ) )
```

```
end if
```

Programming Notes:

Legacy software that performs incomplete instruction decode may incorrectly decode these new instructions, because of their very tight encoding. For example, a disassembler that looks only at the primary opcode field (instruction bits 31-26) to decode BLEZL without checking that the “rt” field is zero violates the pre-Release 6 architecture specification. Complete instruction decode allows reuse of pre-Release 6 BLEZL opcode for Release 6 conditional branches.

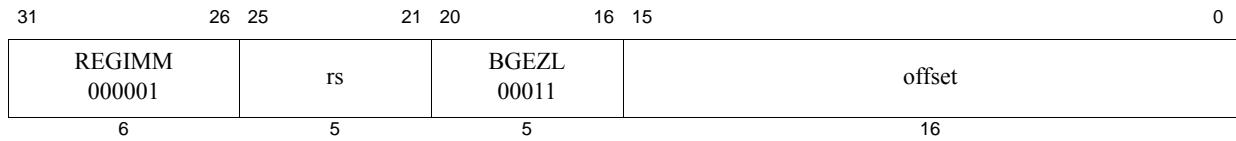

Format: BGEZL *rs*, *offset*

MIPS32, removed in Release 6

Purpose: Branch on Greater Than or Equal to Zero Likely

To test a GPR then do a PC-relative conditional branch; execute the delay slot only if the branch is taken.

Description: if $GPR[rs] \geq 0$ then *branch_likely*

An 18-bit signed offset (the 16-bit *offset* field shifted left 2 bits) is added to the address of the instruction following the branch (not the branch itself), in the branch delay slot, to form a PC-relative effective target address.

If the contents of GPR *rs* are greater than or equal to zero (sign bit is 0), branch to the effective target address after the instruction in the delay slot is executed. If the branch is not taken, the instruction in the delay slot is not executed.

Restrictions:

Processor operation is **UNPREDICTABLE** if a branch, jump, ERET, DERET, or WAIT instruction is placed in the delay slot of a branch or jump.

Availability and Compatibility:

This instruction has been removed in Release 6.

Operation:

```

I:   target_offset ← sign_extend(offset || 02)
      condition ← GPR[rs] ≥ 0GPRLEN
I+1: if condition then
      PC ← PC + target_offset
      else
      NullifyCurrentInstruction()
      endif

```

Exceptions:

None

Implementation Note:

Some implementations always predict that the branch will be taken, and do not use nor do they update the branch internal processor branch prediction tables for this instruction. To maintain performance compatibility, future implementations are encouraged to do the same.

Programming Notes:

With the 18-bit signed instruction offset, the conditional branch range is ± 128 KBytes. Use jump (J) or jump register (JR) to branch to addresses outside this range.

In Pre-Release 6 implementations, software is strongly encouraged to avoid the use of the Branch Likely instructions, as they will be removed from a future revision of the MIPS Architecture.

Some implementations always predict the branch will be taken, so there is a significant penalty if the branch is not taken. Software should only use this instruction when there is a very high probability (98% or more) that the branch will be taken. If the branch is not likely to be taken or if the probability of a taken branch is unknown, software is encouraged to use the BGEZ instruction instead.

Historical Information:

In the MIPS I architecture, this instruction signaled a Reserved Instruction exception.

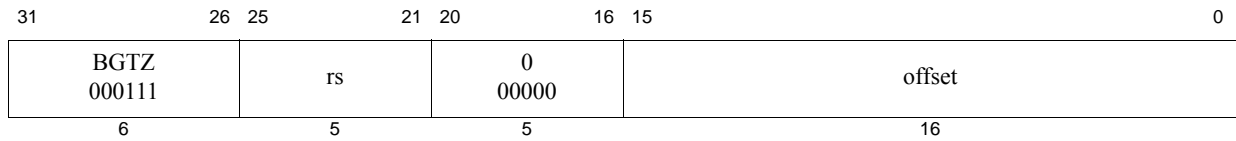

Format: BGTZ *rs*, *offset*

MIPS32

Purpose: Branch on Greater Than Zero

To test a GPR then do a PC-relative conditional branch.

Description: if $GPR[rs] > 0$ then branch

An 18-bit signed offset (the 16-bit *offset* field shifted left 2 bits) is added to the address of the instruction following the branch (not the branch itself), in the branch delay slot, to form a PC-relative effective target address.

If the contents of GPR *rs* are greater than zero (sign bit is 0 but value not zero), branch to the effective target address after the instruction in the delay slot is executed.

Restrictions:

Control Transfer Instructions (CTIs) should not be placed in branch delay slots or Release 6 forbidden slots. CTIs include all branches and jumps, NAL, ERET, ERETNC, DERET, WAIT, and PAUSE.

Pre-Release 6: Processor operation is **UNPREDICTABLE** if a control transfer instruction (CTI) is placed in the delay slot of a branch or jump.

Release 6: If a control transfer instruction (CTI) is executed in the delay slot of a branch or jump, Release 6 implementations are required to signal a Reserved Instruction exception.

Operation:

```

I:   target_offset ← sign_extend(offset || 02)
      condition ← GPR[rs] > 0GPRLEN
I+1: if condition then
      PC ← PC + target_offset
      endif

```

Exceptions:

None

Programming Notes:

With the 18-bit signed instruction offset, the conditional branch range is ± 128 KBytes. Use jump (J) or jump register (JR) to branch to addresses outside this range.

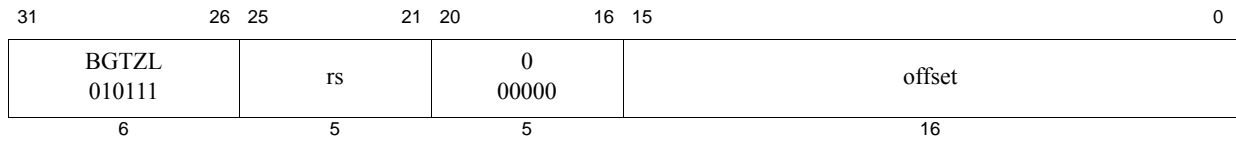

Format: BGTZL *rs*, *offset*

MIPS32, removed in Release 6

Purpose: Branch on Greater Than Zero Likely

To test a GPR then do a PC-relative conditional branch; execute the delay slot only if the branch is taken.

Description: if $GPR[rs] > 0$ then *branch_likely*

An 18-bit signed offset (the 16-bit *offset* field shifted left 2 bits) is added to the address of the instruction following the branch (not the branch itself), in the branch delay slot, to form a PC-relative effective target address.

If the contents of GPR *rs* are greater than zero (sign bit is 0 but value not zero), branch to the effective target address after the instruction in the delay slot is executed. If the branch is not taken, the instruction in the delay slot is not executed.

Restrictions:

Processor operation is **UNPREDICTABLE** if a branch, jump, ERET, DERET, or WAIT instruction is placed in the delay slot of a branch or jump.

Availability and Compatibility:

This instruction has been removed in Release 6.

Operation:

```

I:   target_offset ← sign_extend(offset || 02)
      condition ← GPR[rs] > 0GPRLEN
I+1: if condition then
      PC ← PC + target_offset
      else
      NullifyCurrentInstruction()
      endif

```

Exceptions:

None

Implementation Note:

Some implementations always predict that the branch will be taken, and do not use nor do they update the branch internal processor branch prediction tables for this instruction. To maintain performance compatibility, future implementations are encouraged to do the same.

Programming Notes:

With the 18-bit signed instruction offset, the conditional branch range is ± 128 KBytes. Use jump (J) or jump register (JR) to branch to addresses outside this range.

In Pre-Release 6 implementations, software is strongly encouraged to avoid the use of the Branch Likely instructions, as they will be removed from a future revision of the MIPS Architecture.

Some implementations always predict the branch will be taken, so there is a significant penalty if the branch is not taken. Software should only use this instruction when there is a very high probability (98% or more) that the branch will be taken. If the branch is not likely to be taken or if the probability of a taken branch is unknown, software is

encouraged to use the BGTZ instruction instead.

Historical Information:

In the MIPS I architecture, this instruction signaled a Reserved Instruction exception.

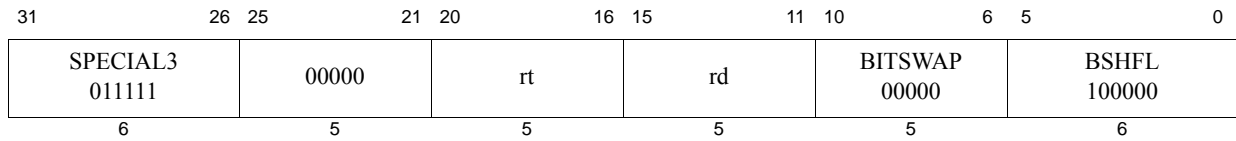

Format: BITSWAP
BITSWAP rd,rt

MIPS32 Release 6

Purpose: Swaps (reverses) bits in each byte

Description: $GPR[rd].byte(i) \leftarrow reverse_bits_in_byte(GPR[rt].byte(i))$, for all bytes i

Each byte in input GPR rt is moved to the same byte position in output GPR rd , with bits in each byte reversed. BITSWAP operates on all 4 bytes of a 32-bit GPR on a 32-bit CPU.

Restrictions:

None.

Availability and Compatibility:

The BITSWAP instruction is introduced by and required as of Release 6.

Operation:

```

BITSWAP:
  for i in 0 to 3 do /* for all bytes in 32-bit GPR width */
    tmp.byte(i) ← reverse_bits_in_byte( GPR[rt].byte(i) )
  endfor
  GPR[rd] ← tmp
  where
    function reverse_bits_in_byte(inbyte)
      outbyte7 ← inbyte0
      outbyte6 ← inbyte1
      outbyte5 ← inbyte2
      outbyte4 ← inbyte3
      outbyte3 ← inbyte4
      outbyte2 ← inbyte5
      outbyte1 ← inbyte6
      outbyte0 ← inbyte7
      return outbyte
    end function

```

Exceptions:

None

Programming Notes:

The Release 6 BITSWAP instruction corresponds to the DSP Module BITREV instruction, except that the latter bit-reverses the least-significant 16-bit halfword of the input register, zero extending the rest, while BITSWAP operates on 32-bits.

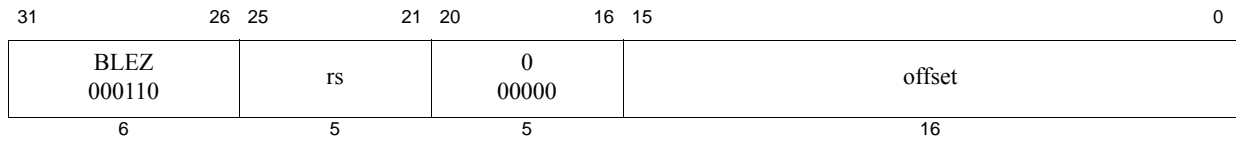

Format: BLEZ *rs*, *offset*

MIPS32

Purpose: Branch on Less Than or Equal to Zero

To test a GPR then do a PC-relative conditional branch.

Description: if $GPR[rs] \leq 0$ then branch

An 18-bit signed offset (the 16-bit *offset* field shifted left 2 bits) is added to the address of the instruction following the branch (not the branch itself), in the branch delay slot, to form a PC-relative effective target address.

If the contents of GPR *rs* are less than or equal to zero (sign bit is 1 or value is zero), branch to the effective target address after the instruction in the delay slot is executed.

Restrictions:

Control Transfer Instructions (CTIs) should not be placed in branch delay slots or Release 6 forbidden slots. CTIs include all branches and jumps, NAL, ERET, ERETNC, DERET, WAIT, and PAUSE.

Pre-Release 6: Processor operation is **UNPREDICTABLE** if a control transfer instruction (CTI) is placed in the delay slot of a branch or jump.

Release 6: If a control transfer instruction (CTI) is executed in the delay slot of a branch or jump, Release 6 implementations are required to signal a Reserved Instruction exception.

Operation:

```

I:   target_offset ← sign_extend(offset || 02)
      condition ← GPR[rs] ≤ 0GPRLEN
I+1: if condition then
      PC ← PC + target_offset
      endif

```

Exceptions:

None

Programming Notes:

With the 18-bit signed instruction offset, the conditional branch range is ± 128 KBytes. Use jump (J) or jump register (JR) to branch to addresses outside this range.

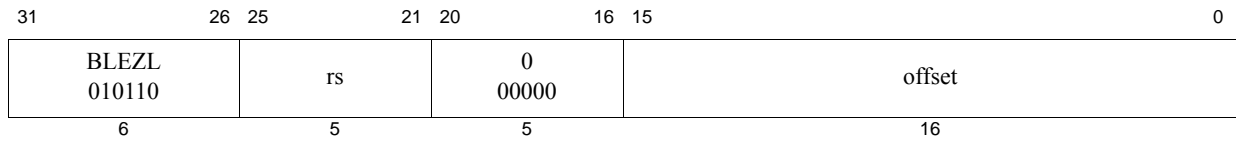

Format: BLEZL *rs*, *offset*

MIPS32, removed in Release 6

Purpose: Branch on Less Than or Equal to Zero Likely

To test a GPR then do a PC-relative conditional branch; execute the delay slot only if the branch is taken.

Description: if $GPR[rs] \leq 0$ then *branch_likely*

An 18-bit signed offset (the 16-bit *offset* field shifted left 2 bits) is added to the address of the instruction following the branch (not the branch itself), in the branch delay slot, to form a PC-relative effective target address.

If the contents of GPR *rs* are less than or equal to zero (sign bit is 1 or value is zero), branch to the effective target address after the instruction in the delay slot is executed. If the branch is not taken, the instruction in the delay slot is not executed.

Restrictions:

Processor operation is **UNPREDICTABLE** if a branch, jump, ERET, DERET, or WAIT instruction is placed in the delay slot of a branch or jump.

Availability and Compatibility:

This instruction has been removed in Release 6.

Operation:

```

I:   target_offset ← sign_extend(offset || 02)
      condition ← GPR[rs] ≤ 0GPRLEN
I+1: if condition then
      PC ← PC + target_offset
      else
      NullifyCurrentInstruction()
      endif

```

Exceptions:

None

Implementation Note:

Some implementations always predict that the branch will be taken, and do not use nor do they update the branch internal processor branch prediction tables for this instruction. To maintain performance compatibility, future implementations are encouraged to do the same.

Programming Notes:

With the 18-bit signed instruction offset, the conditional branch range is ± 128 KBytes. Use jump (J) or jump register (JR) to branch to addresses outside this range.

In Pre-Release 6 implementations, software is strongly encouraged to avoid the use of the Branch Likely instructions, as they will be removed from a future revision of the MIPS Architecture.

Some implementations always predict the branch will be taken, so there is a significant penalty if the branch is not taken. Software should only use this instruction when there is a very high probability (98% or more) that the branch will be taken. If the branch is not likely to be taken or if the probability of a taken branch is unknown, software is

encouraged to use the BLEZ instruction instead.

Historical Information:

In the MIPS I architecture, this instruction signaled a Reserved Instruction exception.

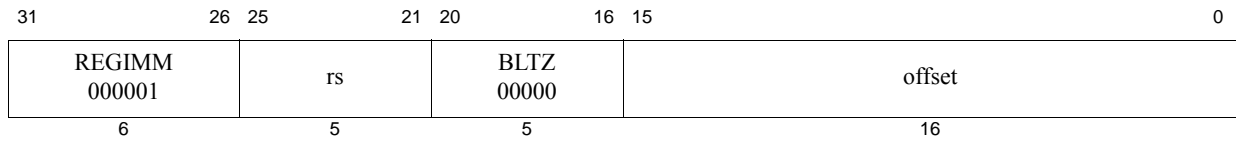

Format: BLTZ *rs*, *offset*

MIPS32

Purpose: Branch on Less Than Zero

To test a GPR then do a PC-relative conditional branch.

Description: if $GPR[rs] < 0$ then branch

An 18-bit signed offset (the 16-bit *offset* field shifted left 2 bits) is added to the address of the instruction following the branch (not the branch itself), in the branch delay slot, to form a PC-relative effective target address.

If the contents of GPR *rs* are less than zero (sign bit is 1), branch to the effective target address after the instruction in the delay slot is executed.

Restrictions:

Control Transfer Instructions (CTIs) should not be placed in branch delay slots or Release 6 forbidden slots. CTIs include all branches and jumps, NAL, ERET, ERETNC, DERET, WAIT, and PAUSE.

Pre-Release 6: Processor operation is **UNPREDICTABLE** if a control transfer instruction (CTI) is placed in the delay slot of a branch or jump.

Release 6: If a control transfer instruction (CTI) is executed in the delay slot of a branch or jump, Release 6 implementations are required to signal a Reserved Instruction exception.

Operation:

```

I:   target_offset ← sign_extend(offset || 02)
      condition ← GPR[rs] < 0GPRLEN
I+1: if condition then
      PC ← PC + target_offset
      endif

```

Exceptions:

None

Programming Notes:

With the 18-bit signed instruction offset, the conditional branch range is ± 128 KBytes. Use jump and link (JAL) or jump and link register (JALR) instructions for procedure calls to addresses outside this range.

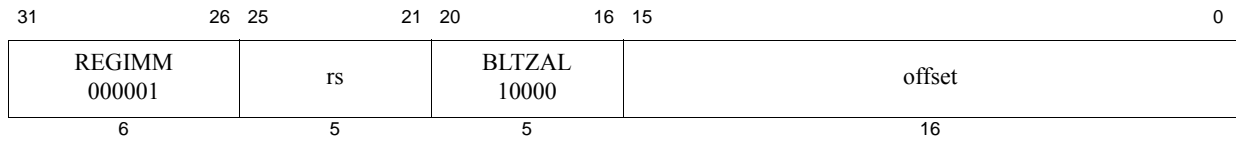

Format: BLTZAL *rs*, *offset*

MIPS32, removed in Release 6

Purpose: Branch on Less Than Zero and Link

To test a GPR then do a PC-relative conditional procedure call.

Description: if GPR[*rs*] < 0 then *procedure_call*

Place the return address link in GPR 31. The return link is the address of the second instruction following the branch, where execution continues after a procedure call.

An 18-bit signed offset (the 16-bit *offset* field shifted left 2 bits) is added to the address of the instruction following the branch (not the branch itself), in the branch delay slot, to form a PC-relative effective target address.

If the contents of GPR *rs* are less than zero (sign bit is 1), branch to the effective target address after the instruction in the delay slot is executed.

Availability and Compatibility:

This instruction has been removed in Release 6.

The special case BLTZAL *r0*, *offset*, has been retained as NAL in Release 6.

Restrictions:

Processor operation is **UNPREDICTABLE** if a branch, jump, ERET, DERET, or WAIT instruction is placed in the delay slot of a branch or jump.

Branch-and-link Restartability: GPR 31 must not be used for the source register *rs*, because such an instruction does not have the same effect when re-executed. The result of executing such an instruction is **UNPREDICTABLE**. This restriction permits an exception handler to resume execution by re-executing the branch when an exception occurs in the branch delay slot.

Operation:

```

I:   target_offset ← sign_extend(offset || 02)
      condition ← GPR[rs] < 0GPRLEN
      GPR[31] ← PC + 8
I+1: if condition then
      PC ← PC + target_offset
      endif

```

Exceptions:

None

Programming Notes:

With the 18-bit signed instruction offset, the conditional branch range is ± 128 KBytes. Use jump and link (JAL) or jump and link register (JALR) instructions for procedure calls to addresses outside this range.

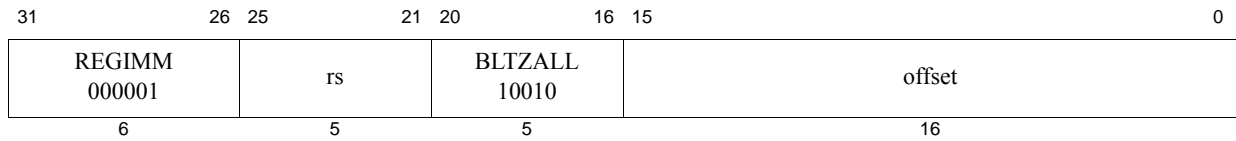

Format: BLTZALL *rs*, *offset*

MIPS32, removed in Release 6

Purpose: Branch on Less Than Zero and Link Likely

To test a GPR then do a PC-relative conditional procedure call; execute the delay slot only if the branch is taken.

Description: if $GPR[rs] < 0$ then `procedure_call_likely`

Place the return address link in GPR 31. The return link is the address of the second instruction following the branch, where execution continues after a procedure call.

An 18-bit signed offset (the 16-bit *offset* field shifted left 2 bits) is added to the address of the instruction following the branch (not the branch itself), in the branch delay slot, to form a PC-relative effective target address.

If the contents of GPR *rs* are less than zero (sign bit is 1), branch to the effective target address after the instruction in the delay slot is executed. If the branch is not taken, the instruction in the delay slot is not executed.

Restrictions:

Processor operation is **UNPREDICTABLE** if a control transfer instruction (CTI) is placed in the delay slot of a branch or jump.

Branch-and-link Restartability: GPR 31 must not be used for the source register *rs*, because such an instruction does not have the same effect when reexecuted. The result of executing such an instruction is **UNPREDICTABLE**. This restriction permits an exception handler to resume execution by reexecuting the branch when an exception occurs in the branch delay slot.

Availability and Compatibility:

This instruction has been removed in Release 6.

Operation:

```

I:   target_offset ← sign_extend(offset || 02)
       condition ← GPR[rs] < 0GPRLEN
       GPR[31] ← PC + 8
I+1: if condition then
       PC ← PC + target_offset
       else
       NullifyCurrentInstruction()
       endif

```

Exceptions:

None

Implementation Note:

Some implementations always predict that the branch will be taken, and do not use nor do they update the branch internal processor branch prediction tables for this instruction. To maintain performance compatibility, future implementations are encouraged to do the same.

Programming Notes:

With the 18-bit signed instruction offset, the conditional branch range is ± 128 KBytes. Use jump and link (JAL) or

jump and link register (JALR) instructions for procedure calls to addresses outside this range.

In Pre-Release 6 implementations, software is strongly encouraged to avoid the use of the Branch Likely instructions, as they will be removed from a future revision of the MIPS Architecture.

Some implementations always predict the branch will be taken, so there is a significant penalty if the branch is not taken. Software should only use this instruction when there is a very high probability (98% or more) that the branch will be taken. If the branch is not likely to be taken or if the probability of a taken branch is unknown, software is encouraged to use the BLTZAL instruction instead.

Historical Information:

In the MIPS I architecture, this instruction signaled a Reserved Instruction exception.

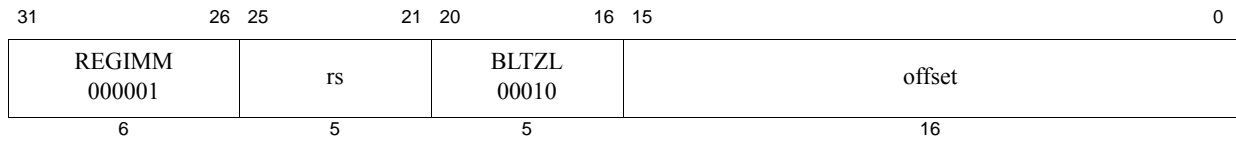

Format: BLTZL *rs*, *offset*

MIPS32, removed in Release 6

Purpose: Branch on Less Than Zero Likely

To test a GPR then do a PC-relative conditional branch; execute the delay slot only if the branch is taken.

Description: if $GPR[rs] < 0$ then *branch_likely*

An 18-bit signed offset (the 16-bit *offset* field shifted left 2 bits) is added to the address of the instruction following the branch (not the branch itself), in the branch delay slot, to form a PC-relative effective target address.

If the contents of GPR *rs* are less than zero (sign bit is 1), branch to the effective target address after the instruction in the delay slot is executed. If the branch is not taken, the instruction in the delay slot is not executed.

Restrictions:

Processor operation is **UNPREDICTABLE** if a branch, jump, ERET, DERET, or WAIT instruction is placed in the delay slot of a branch or jump.

Availability and Compatibility:

This instruction has been removed in Release 6.

Operation:

```

I:   target_offset ← sign_extend(offset || 02)
      condition ← GPR[rs] < 0GPRLEN
I+1: if condition then
      PC ← PC + target_offset
      else
      NullifyCurrentInstruction()
      endif

```

Exceptions:

None

Implementation Note:

Some implementations always predict that the branch will be taken, and do not use nor do they update the branch internal processor branch prediction tables for this instruction. To maintain performance compatibility, future implementations are encouraged to do the same.

Programming Notes:

With the 18-bit signed instruction offset, the conditional branch range is ± 128 KBytes. Use jump (J) or jump register (JR) to branch to addresses outside this range.

In Pre-Release 6 implementations, software is strongly encouraged to avoid the use of the Branch Likely instructions, as they will be removed from a future revision of the MIPS Architecture.

Some implementations always predict the branch will be taken, so there is a significant penalty if the branch is not taken. Software should only use this instruction when there is a very high probability (98% or more) that the branch will be taken. If the branch is not likely to be taken or if the probability of a taken branch is unknown, software is encouraged to use the BLTZ instruction instead.

Historical Information:

In the MIPS I architecture, this instruction signaled a Reserved Instruction exception.

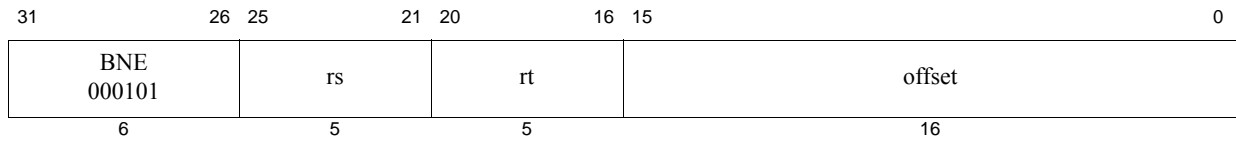

Format: BNE *rs*, *rt*, *offset*

MIPS32

Purpose: Branch on Not Equal

To compare GPRs then do a PC-relative conditional branch

Description: if $GPR[rs] \neq GPR[rt]$ then branch

An 18-bit signed offset (the 16-bit *offset* field shifted left 2 bits) is added to the address of the instruction following the branch (not the branch itself), in the branch delay slot, to form a PC-relative effective target address.

If the contents of GPR *rs* and GPR *rt* are not equal, branch to the effective target address after the instruction in the delay slot is executed.

Restrictions:

Control Transfer Instructions (CTIs) should not be placed in branch delay slots or Release 6 forbidden slots. CTIs include all branches and jumps, NAL, ERET, ERETNC, DERET, WAIT, and PAUSE.

Pre-Release 6: Processor operation is **UNPREDICTABLE** if a control transfer instruction (CTI) is placed in the delay slot of a branch or jump.

Release 6: If a control transfer instruction (CTI) is executed in the delay slot of a branch or jump, Release 6 implementations are required to signal a Reserved Instruction exception.

Operation:

```
I:   target_offset ← sign_extend(offset || 02)
      condition ← (GPR[rs] ≠ GPR[rt])
I+1: if condition then
      PC ← PC + target_offset
      endif
```

Exceptions:

None

Programming Notes:

With the 18-bit signed instruction offset, the conditional branch range is ± 128 KBytes. Use jump (J) or jump register (JR) to branch to addresses outside this range.

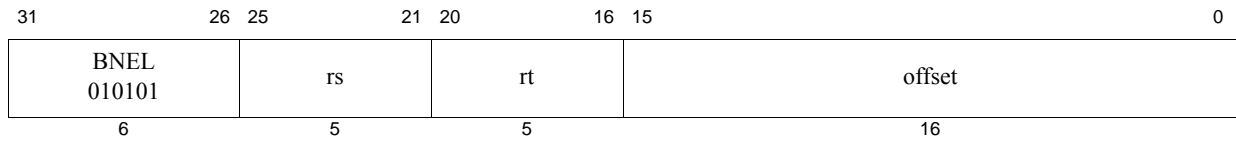

Format: BNEL *rs*, *rt*, *offset*

MIPS32, removed in Release 6

Purpose: Branch on Not Equal Likely

To compare GPRs then do a PC-relative conditional branch; execute the delay slot only if the branch is taken.

Description: if $GPR[rs] \neq GPR[rt]$ then *branch_likely*

An 18-bit signed offset (the 16-bit *offset* field shifted left 2 bits) is added to the address of the instruction following the branch (not the branch itself), in the branch delay slot, to form a PC-relative effective target address.

If the contents of GPR *rs* and GPR *rt* are not equal, branch to the effective target address after the instruction in the delay slot is executed. If the branch is not taken, the instruction in the delay slot is not executed.

Restrictions:

Processor operation is **UNPREDICTABLE** if a branch, jump, ERET, DERET, or WAIT instruction is placed in the delay slot of a branch or jump.

Availability and Compatibility:

This instruction has been removed in Release 6.

Operation:

```

I:   target_offset ← sign_extend(offset || 02)
      condition ← (GPR[rs] ≠ GPR[rt])
I+1: if condition then
      PC ← PC + target_offset
      else
      NullifyCurrentInstruction()
      endif

```

Exceptions:

None

Implementation Note:

Some implementations always predict that the branch will be taken, and do not use nor do they update the branch internal processor branch prediction tables for this instruction. To maintain performance compatibility, future implementations are encouraged to do the same.

Programming Notes:

With the 18-bit signed instruction offset, the conditional branch range is ± 128 KBytes. Use jump (J) or jump register (JR) to branch to addresses outside this range.

In Pre-Release 6 implementations, software is strongly encouraged to avoid the use of the Branch Likely instructions, as they will be removed from a future revision of the MIPS Architecture.

Some implementations always predict the branch will be taken, so there is a significant penalty if the branch is not taken. Software should only use this instruction when there is a very high probability (98% or more) that the branch will be taken. If the branch is not likely to be taken or if the probability of a taken branch is unknown, software is encouraged to use the BNE instruction instead.

Historical Information:

In the MIPS I architecture, this instruction signaled a Reserved Instruction exception.

31	26	25	21	20	16	15	0
POP10 001000		BOVC $rs \geq rt$			offset		
		rs	rt				
POP30 011000		BNVC $rs \geq rt$			offset		
		rs	rt				
6		5		5		16	

Format: BOVC BNVC
 BOVC $rs, rt, offset$
 BNVC $rs, rt, offset$

MIPS32 Release 6
 MIPS32 Release 6

Purpose: Branch on Overflow, Compact; Branch on No Overflow, Compact

BOVC: Detect overflow for add (signed 32 bits) and branch if overflow.

BNVC: Detect overflow for add (signed 32 bits) and branch if no overflow.

Description: `branch if/if-not NotWordValue(GPR[rs]+GPR[rt])`

- BOVC performs a signed 32-bit addition of rs and rt . BOVC discards the sum, but detects signed 32-bit integer overflow of the sum, and branches if such overflow is detected.
- BNVC performs a signed 32-bit addition of rs and rt . BNVC discards the sum, but detects signed 32-bit integer overflow of the sum, and branches if such overflow is not detected.

BOVC and BNVC are compact branches—they have no branch delay slots, but do have a forbidden slot.

A 18-bit signed offset (the 16-bit offset field shifted left 2 bits) is added to the address of the instruction following the branch (not the branch itself), to form a PC-relative effective target address.

The special case with $rt=0$ (for example, $GPR[0]$) is allowed. On MIPS32, BOVC $rs,r0$ offset never branches, while BNVC $rs,r0$ offset always branches.

The special case of $rs=0$ and $rt=0$ is allowed. BOVC never branches, while BNVC always branches.

Restrictions:

Control Transfer Instructions (CTIs) should not be placed in branch delay slots or Release 6 forbidden slots. CTIs include all branches and jumps, NAL, ERET, ERETNC, DERET, WAIT, and PAUSE.

If a control transfer instruction (CTI) is executed in the forbidden slot of a compact branch, Release 6 implementations are required to signal a Reserved Instruction exception, but only when the branch is not taken.

Availability and Compatibility:

These instructions are introduced by and required as of Release 6.

See section [A.4 on page 439](#) in Volume II for a complete overview of Release 6 instruction encodings. Brief notes related to these instructions:

- BOVC uses the primary opcode allocated to MIPS32 pre-Release 6 ADDI. Release 6 reuses the ADDI primary opcode for BOVC and other instructions, distinguished by register numbers.
- BNVC uses the primary opcode allocated to MIPS64 pre-Release 6 DADDI. Release 6 reuses the DADDI primary opcode for BNVC and other instructions, distinguished by register numbers.

Operation:

```
temp1 ← GPR[rs]
temp2 ← GPR[rt]
```

```
tempd ← temp1 + temp2 // wider than 32-bit precision
sum_overflow ← (tempd32 ≠ tempd31)

BOVC: cond ← sum_overflow
BNVC: cond ← not( sum_overflow )

if cond then
    PC ← ( PC+4 + sign_extend( offset << 2 ) )
endif
```

Exceptions:

None

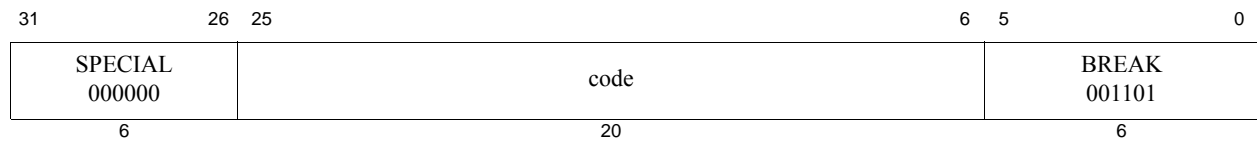

Format: BREAK

MIPS32

Purpose: Breakpoint

To cause a Breakpoint exception

Description:

A breakpoint exception occurs, immediately and unconditionally transferring control to the exception handler. The *code* field is available for use as software parameters, but is retrieved by the exception handler only by loading the contents of the memory word containing the instruction.

Restrictions:

None

Operation:

`SignalException(Breakpoint)`

Exceptions:

Breakpoint

31	26 25	21 20	16 15	11 10	8 7	6	5 4 3	0
COP1 010001	fmt	ft	fs	cc	0	A 0	FC 11	cond
6	5	5	5	3	1	1	2	4

Format: C.cond.fmt

C.cond.S fs, ft (cc = 0 implied)

C.cond.D fs, ft (cc = 0 implied)

C.cond.PS fs, ft (cc = 0 implied)

C.cond.S cc, fs, ft

C.cond.D cc, fs, ft

C.cond.PS cc, fs, ft

MIPS32, removed in Release 6

MIPS32, removed in Release 6

MIPS32 Release 2, removed in Release 6

MIPS32, removed in Release 6

MIPS32, removed in Release 6

MIPS32 Release 2, removed in Release 6

Purpose: Floating Point Compare

To compare FP values and record the Boolean result in a condition code.

Description: $FPConditionCode(cc) \leftarrow FPR[fs] \text{ compare_cond } FPR[ft]$

The value in FPR *fs* is compared to the value in FPR *ft*; the values are in format *fmt*. The comparison is exact and neither overflows nor underflows.

If the comparison specified by the *cond* field of the instruction is true for the operand values, the result is true; otherwise, the result is false. If no exception is taken, the result is written into condition code *CC*; true is 1 and false is 0.

In the *cond* field of the instruction: *cond*_{2..1} specify the nature of the comparison (equals, less than, and so on). *cond*₀ specifies whether the comparison is ordered or unordered, that is, false or true if any operand is a NaN; *cond*₃ indicates whether the instruction should signal an exception on QNaN inputs, or not (see [Table 3.2](#)).

C.cond.PS compares the upper and lower halves of FPR *fs* and FPR *ft* independently and writes the results into condition codes *CC* +1 and *CC* respectively. The *CC* number must be even. If the number is not even the operation of the instruction is **UNPREDICTABLE**.

If one of the values is an SNaN, or *cond*₃ is set and at least one of the values is a QNaN, an Invalid Operation condition is raised and the Invalid Operation flag is set in the *FCSR*. If the Invalid Operation *Enable* bit is set in the *FCSR*, no result is written and an Invalid Operation exception is taken immediately. Otherwise, the Boolean result is written into condition code *CC*.

There are four mutually exclusive ordering relations for comparing floating point values; one relation is always true and the others are false. The familiar relations are *greater than*, *less than*, and *equal*. In addition, the IEEE floating point standard defines the relation *unordered*, which is true when at least one operand value is NaN; NaN compares unordered with everything, including itself. Comparisons ignore the sign of zero, so +0 equals -0.

The comparison condition is a logical predicate, or equation, of the ordering relations such as *less than or equal*, *equal*, *not less than*, or *unordered or equal*. Compare distinguishes among the 16 comparison predicates. The Boolean result of the instruction is obtained by substituting the Boolean value of each ordering relation for the two FP values in the equation. If the *equal* relation is true, for example, then all four example predicates above yield a true result. If the *unordered* relation is true then only the final predicate, *unordered or equal*, yields a true result.

Logical negation of a compare result allows eight distinct comparisons to test for the 16 predicates as shown in [Table 3.2](#). Each mnemonic tests for both a predicate and its logical negation. For each mnemonic, *compare* tests the truth of the first predicate. When the first predicate is true, the result is true as shown in the “If Predicate Is True” column, and the second predicate must be false, and vice versa. (Note that the False predicate is never true and False/True do not follow the normal pattern.)

The truth of the second predicate is the logical negation of the instruction result. After a compare instruction, test for the truth of the first predicate can be made with the Branch on FP True (BC1T) instruction and the truth of the second

can be made with Branch on FP False (BC1F).

Table 3.2 shows another set of eight compare operations, distinguished by a $cond_3$ value of 1 and testing the same 16 conditions. For these additional comparisons, if at least one of the operands is a NaN, including Quiet NaN, then an Invalid Operation condition is raised. If the Invalid Operation condition is enabled in the *FCSR*, an Invalid Operation exception occurs.

Table 3.1 FPU Comparisons Without Special Operand Exceptions

Instruction	Comparison Predicate	Comparison CC Result				Instruction			
Cond Mnemonic	Name of Predicate and Logically Negated Predicate (Abbreviation)	Relation Values				If Predicate Is True	Inv Op Excp. if QNaN?	Condition Field	
		>	<	=	?			3	2..0
F	False [this predicate is always False]	F	F	F	F	F	No	0	0
	True (T)	T	T	T	T				
UN	Unordered	F	F	F	T	T			1
	Ordered (OR)	T	T	T	F	F			
EQ	Equal	F	F	T	F	T			2
	Not Equal (NEQ)	T	T	F	T	F			
UEQ	Unordered or Equal	F	F	T	T	T			3
	Ordered or Greater Than or Less Than (OGL)	T	T	F	F	F			
OLT	Ordered or Less Than	F	T	F	F	T			4
	Unordered or Greater Than or Equal (UGE)	T	F	T	T	F			
ULT	Unordered or Less Than	F	T	F	T	T			5
	Ordered or Greater Than or Equal (OGE)	T	F	T	F	F			
OLE	Ordered or Less Than or Equal	F	T	T	F	T			6
	Unordered or Greater Than (UGT)	T	F	F	T	F			
ULE	Unordered or Less Than or Equal	F	T	T	T	T			7
	Ordered or Greater Than (OGT)	T	F	F	F	F			

Key: ? = unordered, > = greater than, < = less than, = is equal, T = True, F = False

Table 3.2 FPU Comparisons With Special Operand Exceptions for QNaNs

Instruction	Comparison Predicate				Comparison CC Result		Instruction		
Cond Mnemonic	Name of Predicate and Logically Negated Predicate (Abbreviation)	Relation Values				If Predicate Is True	Inv Op Excp If QNaN?	Condition Field	
		>	<	=	?			3	2..0
SF	Signaling False [this predicate always False]	F	F	F	F	F	Yes	1	0
	Signaling True (ST)	T	T	T	T				
NGLE	Not Greater Than or Less Than or Equal	F	F	F	T	T			1
	Greater Than or Less Than or Equal (GLE)	T	T	T	F				
SEQ	Signaling Equal	F	F	T	F	T			2
	Signaling Not Equal (SNE)	T	T	F	T				
NGL	Not Greater Than or Less Than	F	F	T	T	T			3
	Greater Than or Less Than (GL)	T	T	F	F				
LT	Less Than	F	T	F	F	T			4
	Not Less Than (NLT)	T	F	T	T				
NGE	Not Greater Than or Equal	F	T	F	T	T			5
	Greater Than or Equal (GE)	T	F	T	F				
LE	Less Than or Equal	F	T	T	F	T			6
	Not Less Than or Equal (NLE)	T	F	F	T				
NGT	Not Greater Than	F	T	T	T	T			7
	Greater Than (GT)	T	F	F	F				

Key: ? = unordered, > = greater than, < = less than, = is equal, T = True, F = False

Restrictions:

The fields *fs* and *ft* must specify FPRs valid for operands of type *fmt*. If the fields are not valid, the result is **UNPREDICTABLE**.

The operands must be values in format *fmt*; if they are not, the result is **UNPREDICTABLE** and the value of the operand FPRs becomes **UNPREDICTABLE**.

The result of C.cond.PS is **UNPREDICTABLE** if the processor is executing in the *FR*=0 32-bit FPU register model; it is predictable if executing on a 64-bit FPU in the *FR*=1 mode, but not with *FR*=0, and not on a 32-bit FPU,.

The result of C.cond.PS is **UNPREDICTABLE** if the condition code number is odd.

Availability and Compatibility:

This instruction has been removed in Release 6 and has been replaced by the ‘CMP.cond.fmt’ instruction. Refer to the CMP.cond.fmt instruction in this manual for more information. Release 6 does not support Paired Single (PS).

Operation:

```

if SNaN(ValueFPR(fs, fmt)) or SNaN(ValueFPR(ft, fmt)) or
   QNaN(ValueFPR(fs, fmt)) or QNaN(ValueFPR(ft, fmt)) then
  less ← false
  equal ← false
  unordered ← true
if (SNaN(ValueFPR(fs,fmt)) or SNaN(ValueFPR(ft,fmt))) or
   (cond3 and (QNaN(ValueFPR(fs,fmt)) or QNaN(ValueFPR(ft,fmt)))) then

```



```

        SignalException(InvalidOperation)
    endif
else
    less ← ValueFPR(fs, fmt) <_fmt ValueFPR(ft, fmt)
    equal ← ValueFPR(fs, fmt) =_fmt ValueFPR(ft, fmt)
    unordered ← false
endif
condition ← (cond2 and less) or (cond1 and equal)
            or (cond0 and unordered)
SetFPConditionCode(cc, condition)

```

For C.cond.PS, the pseudo code above is repeated for both halves of the operand registers, treating each half as an independent single-precision values. Exceptions on the two halves are logically ORed and reported together. The results of the lower half comparison are written to condition code CC; the results of the upper half comparison are written to condition code CC+1.

Exceptions:

Coprocessor Unusable, Reserved Instruction

Floating Point Exceptions:

Unimplemented Operation, Invalid Operation

Programming Notes:

FP computational instructions, including compare, that receive an operand value of Signaling NaN raise the Invalid Operation condition. Comparisons that raise the Invalid Operation condition for Quiet NaNs in addition to SNaNs permit a simpler programming model if NaNs are errors. Using these compares, programs do not need explicit code to check for QNaNs causing the *unordered* relation. Instead, they take an exception and allow the exception handling system to deal with the error when it occurs. For example, consider a comparison in which we want to know if two numbers are equal, but for which *unordered* would be an error.

```

# comparisons using explicit tests for QNaN
c.eq.d $f2,$f4 # check for equal
nop
bc1t L2 # it is equal
c.un.d $f2,$f4 # it is not equal,
               # but might be unordered
bc1t ERROR # unordered goes off to an error handler
# not-equal-case code here
...
# equal-case code here
L2:
# -----
# comparison using comparisons that signal QNaN
c.seq.d $f2,$f4 # check for equal
nop
bc1t L2 # it is equal
nop
# it is not unordered here
...
# not-equal-case code here
...
# equal-case code here

```

pre-Release 6

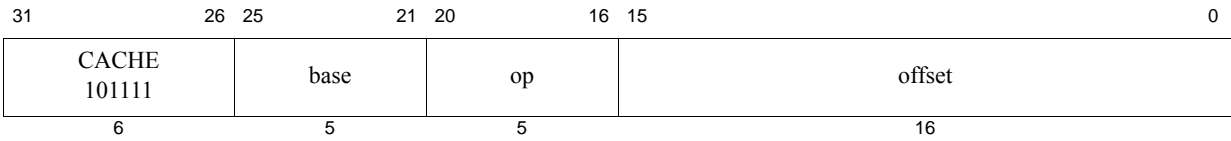

Release 6

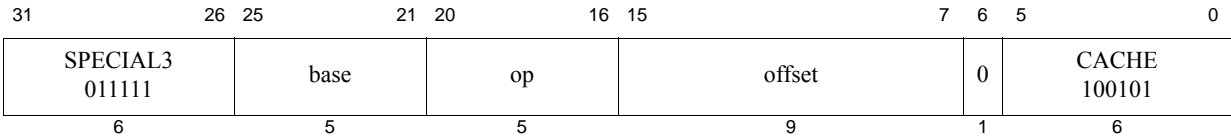

Format: CACHE *op*, *offset*(*base*)

MIPS32

Purpose: Perform Cache Operation

To perform the cache operation specified by *op*.

Description:

The 9-bit offset is sign-extended and added to the contents of the base register to form an effective address. The effective address is used in one of the following ways based on the operation to be performed and the type of cache as described in the following table.

Table 3.3 Usage of Effective Address

Operation Requires an	Type of Cache	Usage of Effective Address
Address	Virtual	The effective address is used to address the cache. An address translation may or may not be performed on the effective address (with the possibility that a TLB Refill or TLB Invalid exception might occur)
Address	Physical	The effective address is translated by the MMU to a physical address. The physical address is then used to address the cache
Index	N/A	<p>The effective address is translated by the MMU to a physical address. It is implementation dependent whether the effective address or the translated physical address is used to index the cache. As such, an unmapped address (such as within <code>kseg0</code>) should always be used for cache operations that require an index. See the Programming Notes section below.</p> <p>Assuming that the total cache size in bytes is <i>CS</i>, the associativity is <i>A</i>, and the number of bytes per tag is <i>BPT</i>, the following calculations give the fields of the address which specify the way and the index:</p> $\begin{aligned} \text{OffsetBit} &\leftarrow \text{Log}_2(\text{BPT}) \\ \text{IndexBit} &\leftarrow \text{Log}_2(\text{CS} / \text{A}) \\ \text{WayBit} &\leftarrow \text{IndexBit} + \text{Ceiling}(\text{Log}_2(\text{A})) \\ \text{Way} &\leftarrow \text{Addr}_{\text{WayBit}-1..\text{IndexBit}} \\ \text{Index} &\leftarrow \text{Addr}_{\text{IndexBit}-1..\text{OffsetBit}} \end{aligned}$ <p>For a direct-mapped cache, the Way calculation is ignored and the Index value fully specifies the cache tag. This is shown symbolically in the figure below.</p>

Figure 3.3 Usage of Address Fields to Select Index and Way

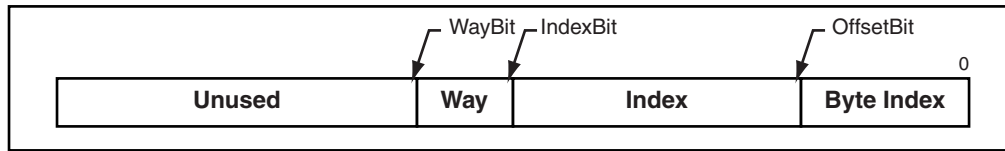

A TLB Refill and TLB Invalid (both with cause code equal TLBL) exception can occur on any operation. For index operations (where the address is used to index the cache but need not match the cache tag), software must use unmapped addresses to avoid TLB exceptions. This instruction never causes TLB Modified exceptions nor TLB Refill exceptions with a cause code of TLBS. This instruction never causes Execute-Inhibit nor Read-Inhibit exceptions.

The effective address may be an arbitrarily-aligned by address. The CACHE instruction never causes an Address Error Exception due to a non-aligned address.

As a result, a Cache Error exception may occur because of some operations performed by this instruction. For example, if a Writeback operation detects a cache or bus error during the processing of the operation, that error is reported via a Cache Error exception. Also, a Bus Error Exception may occur if a bus operation invoked by this instruction is terminated in an error. However, cache error exceptions must not be triggered by an Index Load Tag or Index Store tag operation, as these operations are used for initialization and diagnostic purposes.

An Address Error Exception (with cause code equal AdEL) may occur if the effective address references a portion of the kernel address space which would normally result in such an exception. It is implementation dependent whether such an exception does occur.

It is implementation dependent whether a data watch is triggered by a cache instruction whose address matches the Watch register address match conditions.

The CACHE instruction and the memory transactions which are sourced by the CACHE instruction, such as cache refill or cache writeback, obey the ordering and completion rules of the SYNC instruction.

Bits [17:16] of the instruction specify the cache on which to perform the operation, as follows:

Table 3.4 Encoding of Bits[17:16] of CACHE Instruction

Code	Name	Cache
0b00	I	Primary Instruction
0b01	D	Primary Data or Unified Primary
0b10	T	Tertiary
0b11	S	Secondary

Bits [20:18] of the instruction specify the operation to perform. To provide software with a consistent base of cache operations, certain encodings must be supported on all processors. The remaining encodings are recommended

When implementing multiple level of caches and where the hardware maintains the smaller cache as a proper subset of a larger cache (every address which is resident in the smaller cache is also resident in the larger cache; also known as the inclusion property). It is recommended that the CACHE instructions which operate on the larger, outer-level cache; must first operate on the smaller, inner-level cache. For example, a Hit_Writeback_Invalidate operation targeting the Secondary cache, must first operate on the primary data cache first. If the CACHE instruction implementation does not follow this policy then any software which flushes the caches must mimic this behavior. That is, the software sequences must first operate on the inner cache then operate on the outer cache. The software must place a SYNC instruction after the CACHE instruction whenever there are possible writebacks from the inner cache to

ensure that the writeback data is resident in the outer cache before operating on the outer cache. If neither the CACHE instruction implementation nor the software cache flush sequence follow this policy, then the inclusion property of the caches can be broken, which might be a condition that the cache management hardware cannot properly deal with.

When implementing multiple level of caches without the inclusion property, the use of a SYNC instruction after the CACHE instruction is still needed whenever writeback data has to be resident in the next level of memory hierarchy.

For multiprocessor implementations that maintain coherent caches, some of the Hit type of CACHE instruction operations may optionally affect all coherent caches within the implementation. If the effective address uses a coherent Cache Coherency Attribute (CCA), then the operation is *globalized*, meaning it is broadcast to all of the coherent caches within the system. If the effective address does not use one of the coherent CCAs, there is no broadcast of the operation. If multiple levels of caches are to be affected by one CACHE instruction, all of the affected cache levels must be processed in the same manner - either all affected cache levels use the globalized behavior or all affected cache levels use the non-globalized behavior.

Table 3.5 Encoding of Bits [20:18] of the CACHE Instruction

Code	Caches	Name	Effective Address Operand Type	Operation	Compliance Implemented
0b000	I	Index Invalidate	Index	Set the state of the cache block at the specified index to invalid. This required encoding may be used by software to invalidate the entire instruction cache by stepping through all valid indices.	Required
	D	Index Writeback Invalidate / Index Invalidate	Index	For a write-back cache: If the state of the cache block at the specified index is valid and dirty, write the block back to the memory address specified by the cache tag. After that operation is completed, set the state of the cache block to invalid. If the block is valid but not dirty, set the state of the block to invalid.	Required
	S, T	Index Writeback Invalidate / Index Invalidate	Index	For a write-through cache: Set the state of the cache block at the specified index to invalid. This required encoding may be used by software to invalidate the entire data cache by stepping through all valid indices. The Index Store Tag must be used to initialize the cache at power up.	Required if S, T cache is implemented
0b001	All	Index Load Tag	Index	Read the tag for the cache block at the specified index into the <i>TagLo</i> and <i>TagHi</i> Coprocessor 0 registers. If the <i>DataLo</i> and <i>DataHi</i> registers are implemented, also read the data corresponding to the byte index into the <i>DataLo</i> and <i>DataHi</i> registers. This operation must not cause a Cache Error Exception. The granularity and alignment of the data read into the <i>DataLo</i> and <i>DataHi</i> registers is implementation-dependent, but is typically the result of an aligned access to the cache, ignoring the appropriate low-order bits of the byte index.	Recommended

Table 3.5 Encoding of Bits [20:18] of the CACHE Instruction (Continued)

Code	Caches	Name	Effective Address Operand Type	Operation	Compliance Implemented
0b010	All	Index Store Tag	Index	Write the tag for the cache block at the specified index from the <i>TagLo</i> and <i>TagHi</i> Coprocessor 0 registers. This operation must not cause a Cache Error Exception. This required encoding may be used by software to initialize the entire instruction or data caches by stepping through all valid indices. Doing so requires that the <i>TagLo</i> and <i>TagHi</i> registers associated with the cache be initialized first.	Required
0b011	All	Implementation Dependent	Unspecified	Available for implementation-dependent operation.	Optional
0b100	I, D	Hit Invalidate	Address	If the cache block contains the specified address, set the state of the cache block to invalid. This required encoding may be used by software to invalidate a range of addresses from the instruction cache by stepping through the address range by the line size of the cache.	Required (Instruction Cache Encoding Only), Recommended otherwise
	S, T	Hit Invalidate	Address	In multiprocessor implementations with coherent caches, the operation may optionally be broadcast to all coherent caches within the system.	Optional, if <i>Hit_Invalidate_D</i> is implemented, the S and T variants are recommended.
0b101	I	Fill	Address	Fill the cache from the specified address.	Recommended
	D	Hit Writeback Invalidate / Hit Invalidate	Address	For a write-back cache: If the cache block contains the specified address and it is valid and dirty, write the contents back to memory. After that operation is completed, set the state of the cache block to invalid. If the block is valid but not dirty, set the state of the block to invalid.	Required
	S, T	Hit Writeback Invalidate / Hit Invalidate	Address	For a write-through cache: If the cache block contains the specified address, set the state of the cache block to invalid. This required encoding may be used by software to invalidate a range of addresses from the data cache by stepping through the address range by the line size of the cache. In multiprocessor implementations with coherent caches, the operation may optionally be broadcast to all coherent caches within the system.	Required if S, T cache is implemented

Table 3.5 Encoding of Bits [20:18] of the CACHE Instruction (Continued)

Code	Caches	Name	Effective Address Operand Type	Operation	Compliance Implemented
0b110	D	Hit Writeback	Address	<p>If the cache block contains the specified address and it is valid and dirty, write the contents back to memory. After the operation is completed, leave the state of the line valid, but clear the dirty state. For a write-through cache, this operation may be treated as a nop.</p> <p>In multiprocessor implementations with coherent caches, the operation may optionally be broadcast to all coherent caches within the system.</p>	Recommended
	S, T	Hit Writeback	Address		Optional, if Hit_Writeback_D is implemented, the S and T variants are recommended.
0b111	I, D	Fetch and Lock	Address	<p>If the cache does not contain the specified address, fill it from memory, performing a write-back if required. Set the state to valid and locked.</p> <p>If the cache already contains the specified address, set the state to locked. In set-associative or fully-associative caches, the way selected on a fill from memory is implementation dependent.</p> <p>The lock state may be cleared by executing an Index Invalidate, Index Writeback Invalidate, Hit Invalidate, or Hit Writeback Invalidate operation to the locked line, or via an Index Store Tag operation to the line that clears the lock bit. Clearing the lock state via Index Store Tag is dependent on the implementation-dependent cache tag and cache line organization, and that Index and Index Writeback Invalidate operations are dependent on cache line organization. Only Hit and Hit Writeback Invalidate operations are generally portable across implementations.</p> <p>It is implementation dependent whether a locked line is displaced as the result of an external invalidate or intervention that hits on the locked line. Software must not depend on the locked line remaining in the cache if an external invalidate or intervention would invalidate the line if it were not locked.</p> <p>It is implementation dependent whether a Fetch and Lock operation affects more than one line. For example, more than one line around the referenced address may be fetched and locked. It is recommended that only the single line containing the referenced address be affected.</p>	Recommended

Restrictions:

The operation of this instruction is **UNDEFINED** for any operation/cache combination that is not implemented. In Release 6, the instruction in this case should perform no operation.

The operation of this instruction is **UNDEFINED** if the operation requires an address, and that address is uncacheable. In Release 6, the instruction in this case should perform no operation.

The operation of the instruction is **UNPREDICTABLE** if the cache line that contains the CACHE instruction is the target of an invalidate or a writeback invalidate.

If this instruction is used to lock all ways of a cache at a specific cache index, the behavior of that cache to subsequent cache misses to that cache index is **UNDEFINED**.

If access to Coprocessor 0 is not enabled, a Coprocessor Unusable Exception is signaled.

Any use of this instruction that can cause cacheline writebacks should be followed by a subsequent SYNC instruction to avoid hazards where the writeback data is not yet visible at the next level of the memory hierarchy.

This instruction does not produce an exception for a misaligned memory address, since it has no memory access size.

Availability and Compatibility:

This instruction has been recoded for Release 6.

Operation:

```
vAddr ← GPR[base] + sign_extend(offset)
(pAddr, uncached) ← AddressTranslation(vAddr, DataReadReference)
CacheOp(op, vAddr, pAddr)
```

Exceptions:

TLB Refill Exception.

TLB Invalid Exception

Coprocessor Unusable Exception

Address Error Exception

Cache Error Exception

Bus Error Exception

Programming Notes:

Release 6 architecture implements a 9-bit offset, whereas all release levels lower than Release 6 implement a 16-bit offset.

For cache operations that require an index, it is implementation dependent whether the effective address or the translated physical address is used as the cache index. Therefore, the index value should always be converted to an unmapped address (such as an kseg0 address - by ORing the index with 0x80000000 before being used by the cache instruction). For example, the following code sequence performs a data cache Index Store Tag operation using the index passed in GPR a0:

```
li    a1, 0x80000000    /* Base of kseg0 segment */
or    a0, a0, a1        /* Convert index to kseg0 address */
cache DCIndexStTag, 0(a1) /* Perform the index store tag operation */
```

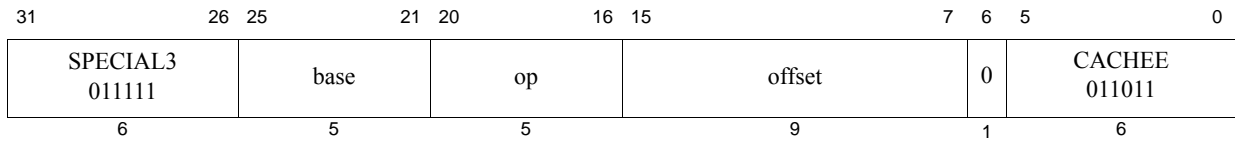
Format: CACHEE op, offset(base)

MIPS32

Purpose: Perform Cache Operation EVA

To perform the cache operation specified by op using a user mode virtual address while in kernel mode.

Description:

The 9-bit offset is sign-extended and added to the contents of the base register to form an effective address. The effective address is used in one of the following ways based on the operation to be performed and the type of cache as described in the following table.

Table 3.6 Usage of Effective Address

Operation Requires an	Type of Cache	Usage of Effective Address
Address	Virtual	The effective address is used to address the cache. An address translation may or may not be performed on the effective address (with the possibility that a TLB Refill or TLB Invalid exception might occur)
Address	Physical	The effective address is translated by the MMU to a physical address. The physical address is then used to address the cache
Index	N/A	<p>The effective address is translated by the MMU to a physical address. It is implementation dependent whether the effective address or the translated physical address is used to index the cache. As such, a kseg0 address should always be used for cache operations that require an index. See the Programming Notes section below.</p> <p>Assuming that the total cache size in bytes is CS, the associativity is A, and the number of bytes per tag is BPT, the following calculations give the fields of the address which specify the way and the index:</p> $\text{OffsetBit} \leftarrow \text{Log}_2(\text{BPT})$ $\text{IndexBit} \leftarrow \text{Log}_2(\text{CS} / \text{A})$ $\text{WayBit} \leftarrow \text{IndexBit} + \text{Ceiling}(\text{Log}_2(\text{A}))$ $\text{Way} \leftarrow \text{Addr}_{\text{WayBit}-1.. \text{IndexBit}}$ $\text{Index} \leftarrow \text{Addr}_{\text{IndexBit}-1.. \text{OffsetBit}}$ <p>For a direct-mapped cache, the Way calculation is ignored and the Index value fully specifies the cache tag. This is shown symbolically in the figure below.</p>

Figure 3.4 Usage of Address Fields to Select Index and Way

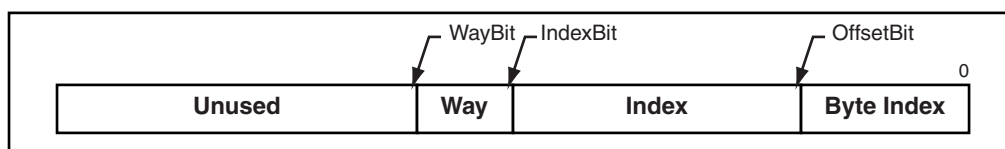

A TLB Refill and TLB Invalid (both with cause code equal TLBL) exception can occur on any operation. For index

operations (where the address is used to index the cache but need not match the cache tag) software should use unmapped addresses to avoid TLB exceptions. This instruction never causes TLB Modified exceptions nor TLB Refill exceptions with a cause code of TLBS. This instruction never causes Execute-Inhibit nor Read-Inhibit exceptions.

The effective address may be an arbitrarily-aligned by address. The CACHEE instruction never causes an Address Error Exception due to a non-aligned address.

A Cache Error exception may occur as a by-product of some operations performed by this instruction. For example, if a Writeback operation detects a cache or bus error during the processing of the operation, that error is reported via a Cache Error exception. Similarly, a Bus Error Exception may occur if a bus operation invoked by this instruction is terminated in an error. However, cache error exceptions must not be triggered by an Index Load Tag or Index Store tag operation, as these operations are used for initialization and diagnostic purposes.

An Address Error Exception (with cause code equal AdEL) may occur if the effective address references a portion of the kernel address space which would normally result in such an exception. It is implementation dependent whether such an exception does occur.

It is implementation dependent whether a data watch is triggered by a cache instruction whose address matches the Watch register address match conditions.

The CACHEE instruction and the memory transactions which are sourced by the CACHEE instruction, such as cache refill or cache writeback, obey the ordering and completion rules of the SYNC instruction.

Bits [17:16] of the instruction specify the cache on which to perform the operation, as follows:

Table 3.7 Encoding of Bits[17:16] of CACHEE Instruction

Code	Name	Cache
0b00	I	Primary Instruction
0b01	D	Primary Data or Unified Primary
0b10	T	Tertiary
0b11	S	Secondary

Bits [20:18] of the instruction specify the operation to perform. To provide software with a consistent base of cache operations, certain encodings must be supported on all processors. The remaining encodings are recommended

When implementing multiple level of caches and where the hardware maintains the smaller cache as a proper subset of a larger cache, it is recommended that the CACHEE instructions must first operate on the smaller, inner-level cache. For example, a Hit_Writeback_Invalidate operation targeting the Secondary cache, must first operate on the primary data cache first. If the CACHEE instruction implementation does not follow this policy then any software which flushes the caches must mimic this behavior. That is, the software sequences must first operate on the inner cache then operate on the outer cache. The software must place a SYNC instruction after the CACHEE instruction whenever there are possible writebacks from the inner cache to ensure that the writeback data is resident in the outer cache before operating on the outer cache. If neither the CACHEE instruction implementation nor the software cache flush sequence follow this policy, then the inclusion property of the caches can be broken, which might be a condition that the cache management hardware cannot properly deal with.

When implementing multiple level of caches without the inclusion property, you must use SYNC instruction after the CACHEE instruction whenever writeback data has to be resident in the next level of memory hierarchy.

For multiprocessor implementations that maintain coherent caches, some of the Hit type of CACHEE instruction operations may optionally affect all coherent caches within the implementation. If the effective address uses a coherent Cache Coherency Attribute (CCA), then the operation is *globalized*, meaning it is broadcast to all of the coherent

caches within the system. If the effective address does not use one of the coherent CCAs, there is no broadcast of the operation. If multiple levels of caches are to be affected by one CACHEE instruction, all of the affected cache levels must be processed in the same manner — either all affected cache levels use the globalized behavior or all affected cache levels use the non-globalized behavior.

The CACHEE instruction functions the same as the CACHE instruction, except that address translation is performed using the user mode virtual address space mapping in the TLB when accessing an address within a memory segment configured to use the MUSUK access mode. Memory segments using UUSK or MUSK access modes are also accessible. Refer to Volume III, Enhanced Virtual Addressing section for additional information.

Implementation of this instruction is specified by the *Config5_{EVA}* field being set to 1.

Table 3.8 Encoding of Bits [20:18] of the CACHEE Instruction

Code	Caches	Name	Effective Address Operand Type	Operation	Compliance Implemented
0b000	I	Index Invalidate	Index	Set the state of the cache block at the specified index to invalid. This required encoding may be used by software to invalidate the entire instruction cache by stepping through all valid indices.	Required
	D	Index Writeback Invalidate / Index Invalidate	Index	For a write-back cache: If the state of the cache block at the specified index is valid and dirty, write the block back to the memory address specified by the cache tag. After that operation is completed, set the state of the cache block to invalid. If the block is valid but not dirty, set the state of the block to invalid.	Required
	S, T	Index Writeback Invalidate / Index Invalidate	Index	For a write-through cache: Set the state of the cache block at the specified index to invalid. This required encoding may be used by software to invalidate the entire data cache by stepping through all valid indices. Note that Index Store Tag should be used to initialize the cache at power up.	Required if S, T cache is implemented
0b001	All	Index Load Tag	Index	Read the tag for the cache block at the specified index into the <i>TagLo</i> and <i>TagHi</i> Coprocessor 0 registers. If the <i>DataLo</i> and <i>DataHi</i> registers are implemented, also read the data corresponding to the byte index into the <i>DataLo</i> and <i>DataHi</i> registers. This operation must not cause a Cache Error Exception. The granularity and alignment of the data read into the <i>DataLo</i> and <i>DataHi</i> registers is implementation-dependent, but is typically the result of an aligned access to the cache, ignoring the appropriate low-order bits of the byte index.	Recommended

Table 3.8 Encoding of Bits [20:18] of the CACHEE Instruction (Continued)

Code	Caches	Name	Effective Address Operand Type	Operation	Compliance Implemented
0b010	All	Index Store Tag	Index	Write the tag for the cache block at the specified index from the <i>TagLo</i> and <i>TagHi</i> Coprocessor 0 registers. This operation must not cause a Cache Error Exception. This required encoding may be used by software to initialize the entire instruction or data caches by stepping through all valid indices. Doing so requires that the <i>TagLo</i> and <i>TagHi</i> registers associated with the cache be initialized first.	Required
0b011	All	Implementation Dependent	Unspecified	Available for implementation-dependent operation.	Optional
0b100	I, D	Hit Invalidate	Address	If the cache block contains the specified address, set the state of the cache block to invalid. This required encoding may be used by software to invalidate a range of addresses from the instruction cache by stepping through the address range by the line size of the cache.	Required (Instruction Cache Encoding Only), Recommended otherwise
	S, T	Hit Invalidate	Address	In multiprocessor implementations with coherent caches, the operation may optionally be broadcast to all coherent caches within the system.	Optional, if <i>Hit_Invalidate_D</i> is implemented, the S and T variants are recommended.
0b101	I	Fill	Address	Fill the cache from the specified address.	Recommended
	D	Hit Writeback Invalidate / Hit Invalidate	Address	For a write-back cache: If the cache block contains the specified address and it is valid and dirty, write the contents back to memory. After that operation is completed, set the state of the cache block to invalid. If the block is valid but not dirty, set the state of the block to invalid.	Required
	S, T	Hit Writeback Invalidate / Hit Invalidate	Address	For a write-through cache: If the cache block contains the specified address, set the state of the cache block to invalid. This required encoding may be used by software to invalidate a range of addresses from the data cache by stepping through the address range by the line size of the cache. In multiprocessor implementations with coherent caches, the operation may optionally be broadcast to all coherent caches within the system.	Required if S, T cache is implemented

Table 3.8 Encoding of Bits [20:18] of the CACHEE Instruction (Continued)

Code	Caches	Name	Effective Address Operand Type	Operation	Compliance Implemented
0b110	D	Hit Writeback	Address	<p>If the cache block contains the specified address and it is valid and dirty, write the contents back to memory. After the operation is completed, leave the state of the line valid, but clear the dirty state. For a write-through cache, this operation may be treated as a nop.</p> <p>In multiprocessor implementations with coherent caches, the operation may optionally be broadcast to all coherent caches within the system.</p>	Recommended
	S, T	Hit Writeback	Address		Optional, if Hit_Writeback_D is implemented, the S and T variants are recommended.
0b111	I, D	Fetch and Lock	Address	<p>If the cache does not contain the specified address, fill it from memory, performing a write-back if required. Set the state to valid and locked.</p> <p>If the cache already contains the specified address, set the state to locked. In set-associative or fully-associative caches, the way selected on a fill from memory is implementation dependent.</p> <p>The lock state may be cleared by executing an Index Invalidate, Index Writeback Invalidate, Hit Invalidate, or Hit Writeback Invalidate operation to the locked line, or via an Index Store Tag operation to the line that clears the lock bit. Clearing the lock state via Index Store Tag is dependent on the implementation-dependent cache tag and cache line organization, and that Index and Index Writeback Invalidate operations are dependent on cache line organization. Only Hit and Hit Writeback Invalidate operations are generally portable across implementations.</p> <p>It is implementation dependent whether a locked line is displaced as the result of an external invalidate or intervention that hits on the locked line. Software must not depend on the locked line remaining in the cache if an external invalidate or intervention would invalidate the line if it were not locked.</p> <p>It is implementation dependent whether a Fetch and Lock operation affects more than one line. For example, more than one line around the referenced address may be fetched and locked. It is recommended that only the single line containing the referenced address be affected.</p>	Recommended

Restrictions:

The operation of this instruction is **UNDEFINED** for any operation/cache combination that is not implemented. In Release 6, the instruction in this case should perform no operation.

The operation of this instruction is **UNDEFINED** if the operation requires an address, and that address is uncacheable. In Release 6, the instruction in this case should perform no operation.

The operation of the instruction is **UNPREDICTABLE** if the cache line that contains the CACHEE instruction is the target of an invalidate or a writeback invalidate.

If this instruction is used to lock all ways of a cache at a specific cache index, the behavior of that cache to subsequent cache misses to that cache index is **UNDEFINED**.

Any use of this instruction that can cause cacheline writebacks should be followed by a subsequent SYNC instruction to avoid hazards where the writeback data is not yet visible at the next level of the memory hierarchy.

Only usable when access to Coprocessor0 is enabled and when accessing an address within a segment configured using UUSK, MUSK or MUSUK access mode.

This instruction does not produce an exception for a misaligned memory address, since it has no memory access size.

Operation:

```
vAddr ← GPR[base] + sign_extend(offset)
(pAddr, uncached) ← AddressTranslation(vAddr, DataReadReference)
CacheOp(op, vAddr, pAddr)
```

Exceptions:

TLB Refill Exception.

TLB Invalid Exception

Coprocessor Unusable Exception

Reserved Instruction

Address Error Exception

Cache Error Exception

Bus Error Exception

Programming Notes:

For cache operations that require an index, it is implementation dependent whether the effective address or the translated physical address is used as the cache index. Therefore, the index value should always be converted to a kseg0 address by ORing the index with 0x80000000 before being used by the cache instruction. For example, the following code sequence performs a data cache Index Store Tag operation using the index passed in GPR a0:

```
li    a1, 0x80000000    /* Base of kseg0 segment */
or    a0, a0, a1        /* Convert index to kseg0 address */
cache DCIndexStTag, 0(a1) /* Perform the index store tag operation */
```

31	26 25	21 20	16 15	11 10	6 5	0
COP1 010001	fmt	0 00000	fs	fd	CEIL.L 001010	
6	5	5	5	5	6	

Format: CEIL.L.fmt
 CEIL.L.S fd, fs
 CEIL.L.D fd, fs

MIPS32 Release 2
MIPS32 Release 2

Purpose: Fixed Point Ceiling Convert to Long Fixed Point

To convert an FP value to 64-bit fixed point, rounding up.

Description: $FPR[fd] \leftarrow \text{convert_and_round}(FPR[fs])$

The value in FPR *fs*, in format *fmt*, is converted to a value in 64-bit long fixed point format and rounding toward + ∞ (rounding mode 2). The result is placed in FPR *fd*.

When the source value is Infinity, NaN, or rounds to an integer outside the range $-2^{63}-1$ to $2^{63}-1$, the result cannot be represented correctly, an IEEE Invalid Operation condition exists, and the Invalid Operation flag is set in the *FCSR*. If the Invalid Operation *Enable* bit is set in the *FCSR*, no result is written to *fd* and an Invalid Operation exception is taken immediately. Otherwise, a default result is written to *fd*. On cores with $FCSR_{NAN2008}=0$, the default result is $2^{63}-1$. On cores with $FCSR_{NAN2008}=1$, the default result is:

- 0 when the input value is NaN
- $2^{63}-1$ when the input value is $+\infty$ or rounds to a number larger than $2^{63}-1$
- $-2^{63}-1$ when the input value is $-\infty$ or rounds to a number smaller than $-2^{63}-1$

Restrictions:

The fields *fs* and *fd* must specify valid FPRs: *fs* for type *fmt* and *fd* for long fixed point. If the fields are not valid, the result is **UNPREDICTABLE**.

The operand must be a value in format *fmt*; if it is not, the result is **UNPREDICTABLE** and the value of the operand FPR becomes **UNPREDICTABLE**.

The result of this instruction is **UNPREDICTABLE** if the processor is executing in the $FR=0$ 32-bit FPU register model; it is predictable if executing on a 64-bit FPU in the $FR=1$ mode, but not with $FR=0$, and not on a 32-bit FPU.

Operation:

$\text{StoreFPR}(fd, L, \text{ConvertFmt}(\text{ValueFPR}(fs, fmt), fmt, L))$

Exceptions:

Coprocessor Unusable, Reserved Instruction

Floating Point Exceptions:

Invalid Operation, Unimplemented Operation, Inexact

31	26 25	21 20	16 15	11 10	6 5	0
COP1 010001	fmt	0 00000	fs	fd	CEIL.W 001110	
6	5	5	5	5	6	

Format: CEIL.W.fmt

CEIL.W.S fd, fs

CEIL.W.D fd, fs

MIPS32

MIPS32

Purpose: Floating Point Ceiling Convert to Word Fixed Point

To convert an FP value to 32-bit fixed point, rounding up

Description: $FPR[fd] \leftarrow \text{convert_and_round}(FPR[fs])$

The value in FPR *fs*, in format *fmt*, is converted to a value in 32-bit word fixed point format and rounding toward $+\infty$ (rounding mode 2). The result is placed in FPR *fd*.

When the source value is Infinity, NaN, or rounds to an integer outside the range -2^{31} to $2^{31}-1$, the result cannot be represented correctly, an IEEE Invalid Operation condition exists, and the Invalid Operation flag is set in the *FCSR*. If the Invalid Operation *Enable* bit is set in the *FCSR*, no result is written to *fd* and an Invalid Operation exception is taken immediately. Otherwise, a default result is written to *fd*. On cores with $FCSR_{NAN2008}=0$, the default result is $2^{31}-1$. On cores with $FCSR_{NAN2008}=1$, the default result is:

- 0 when the input value is NaN
- $2^{31}-1$ when the input value is $+\infty$ or rounds to a number larger than $2^{31}-1$
- $-2^{31}-1$ when the input value is $-\infty$ or rounds to a number smaller than $-2^{31}-1$

Restrictions:

The fields *fs* and *fd* must specify valid FPRs; *fs* for type *fmt* and *fd* for word fixed point. If the fields are not valid, the result is **UNPREDICTABLE**.

The operand must be a value in format *fmt*; if it is not, the result is **UNPREDICTABLE** and the value of the operand FPR becomes **UNPREDICTABLE**.

Operation:

$\text{StoreFPR}(fd, W, \text{ConvertFmt}(\text{ValueFPR}(fs, fmt), fmt, W))$

Exceptions:

Coprocessor Unusable, Reserved Instruction

Floating Point Exceptions:

Invalid Operation, Unimplemented Operation, Inexact

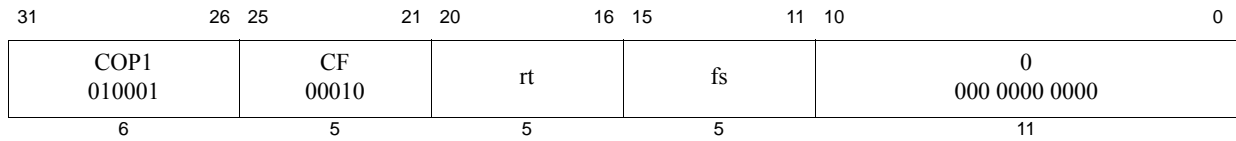

Format: CFC1 rt, fs

MIPS32

Purpose: Move Control Word From Floating Point

To copy a word from an FPU control register to a GPR.

Description: $GPR[rt] \leftarrow FP_Control[fs]$

Copy the 32-bit word from FP (coprocessor 1) control register *fs* into GPR *rt*.

The definition of this instruction has been extended in Release 5 to support user mode read and write of *Status_{FR}* under the control of *Config5_{UFR}*. This optional feature is meant to facilitate transition from *FR=0* to *FR=1* floating-point register modes in order to obsolete *FR=0* mode in a future architecture release. User code may set and clear *Status_{FR}* without kernel intervention, providing kernel explicitly provides permission.

This UFR facility is not supported in Release 6 because Release 6 only allows *FR=1* mode. Accessing the UFR and UNFR registers causes a Reserved Instruction exception in Release 6 because *FIR_{UFRP}* is always 0.

The definition of this instruction has been extended in Release 6 to allow user code to read and modify the *Config5_{FRE}* bit. Such modification is allowed when this bit is present (as indicated by *FIR_{UFRP}*) and user mode modification of the bit is enabled by the kernel (as indicated by *Config5_{UFE}*). Setting *Config5_{FRE}* to 1 causes all floating point instructions which are not compatible with *FR=1* mode to take an Reserved Instruction exception. This makes it possible to run pre-Release 6 *FR=0* floating point code on a Release 6 core which only supports *FR=1* mode, provided the kernel has been set up to trap and emulate *FR=0* behavior for these instructions. These instructions include floating-point arithmetic instructions that read/write single-precision registers, LWC1, SWC1, MTC1, and MFC1 instructions.

The FRE facility uses COP1 register aliases FRE and NFRE to access *Config5_{FRE}*.

Restrictions:

There are a few control registers defined for the floating point unit. Prior to Release 6, the result is **UNPREDICTABLE** if *fs* specifies a register that does not exist. In Release 6 and later, a Reserved Instruction exception occurs if *fs* specifies a register that does not exist.

The result is **UNPREDICTABLE** if *fs* specifies the UNFR or NFRE write-only control. Release 6 and later implementations are required to produce a Reserved Instruction exception; software must assume it is **UNPREDICTABLE**.

Operation:

```

if fs = 0 then
    temp ← FIR
elseif fs = 1 then /* read UFR (CP1 Register 1) */
    if FIRUFRP then
        if not Config5UFR then SignalException(ReservedInstruction) endif
        temp ← StatusFR
    else
        if ConfigAR ≥ 2 SignalException(ReservedInstruction) /* Release 6 traps */
        endif
        temp ← UNPREDICTABLE
    endif
endif

```

```

elseif fs = 4 then /* read fs=4 UNFR not supported for reading - UFR suffices */
    if ConfigAR ≥ 2 SignalException(ReservedInstruction) /* Release 6 traps */
    endif
    temp ← UNPREDICTABLE
elseif fs=5 then /* user read of FRE, if permitted */
    if ConfigAR ≤ 2 then temp ← UNPREDICTABLE
    else
        if not Config5UFR then SignalException(ReservedInstruction) endif
        temp ← 031 || Config5FRE
    endif
elseif fs = 25 then /* FCCR */
    temp ← 024 || FCSR31..25 || FCSR23
elseif fs = 26 then /* FEXR */
    temp ← 014 || FCSR17..12 || 05 || FCSR6..2 || 02
elseif fs = 28 then /* FENR */
    temp ← 020 || FCSR11..7 || 04 || FCSR24 || FCSR1..0
elseif fs = 31 then /* FCSR */
    temp ← FCSR
else
    if Config2AR ≥ 2 SignalException(ReservedInstruction)
    /*Release 6 traps; includes NFRE*/
    endif
    temp ← UNPREDICTABLE
endif

if Config2AR < 2 then
    GPR[rt] ← temp
endif

```

Exceptions:

Coprocessor Unusable, Reserved Instruction

Historical Information:

For the MIPS I, II and III architectures, the contents of GPR *rt* are **UNPREDICTABLE** for the instruction immediately following CFC1.

MIPS V and MIPS32 introduced the three control registers that access portions of FCSR. These registers were not available in MIPS I, II, III, or IV.

MIPS32 Release 5 introduced the UFR and UNFR register aliases that allow user level access to *Status_{FR}*. Release 6 removes them.

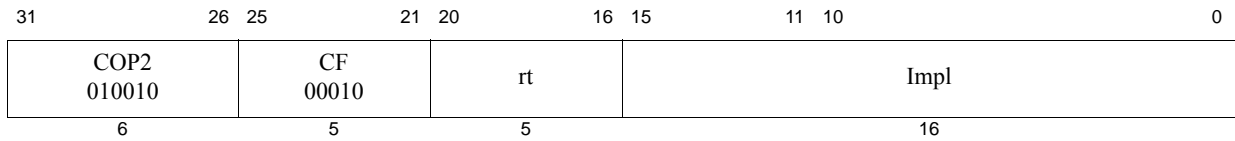

Format: CFC2 rt, Impl

MIPS32

The syntax shown above is an example using CFC1 as a model. The specific syntax is implementation dependent.

Purpose: Move Control Word From Coprocessor 2

To copy a word from a Coprocessor 2 control register to a GPR

Description: $GPR[rt] \leftarrow CP2CCR[Impl]$

Copy the 32-bit word from the Coprocessor 2 control register denoted by the *Impl* field. The interpretation of the *Impl* field is left entirely to the Coprocessor 2 implementation and is not specified by the architecture.

Restrictions:

The result is **UNPREDICTABLE** if *Impl* specifies a register that does not exist.

Operation:

```
temp ← CP2CCR[Impl]
GPR[rt] ← temp
```

Exceptions:

Coprocessor Unusable, Reserved Instruction

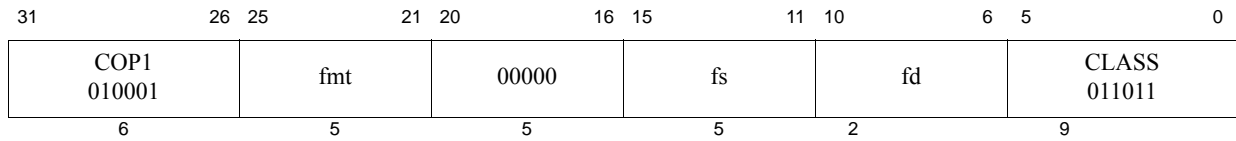

Format: CLASS.fmt
 CLASS.S fd, fs
 CLASS.D fd, fs

MIPS32 Release 6
MIPS32 Release 6

Purpose: Scalar Floating-Point Class Mask

Scalar floating-point class shown as a bit mask for Zero, Negative, Infinite, Subnormal, Quiet NaN, or Signaling NaN.

Description: $FPR[fd] \leftarrow class(FPR[fs])$

Stores in *fd* a bit mask reflecting the floating-point class of the floating point scalar value *fs*.

The mask has 10 bits as follows. Bits 0 and 1 indicate NaN values: signaling NaN (bit 0) and quiet NaN (bit 1). Bits 2, 3, 4, 5 classify negative values: infinity (bit 2), normal (bit 3), subnormal (bit 4), and zero (bit 5). Bits 6, 7, 8, 9 classify positive values: infinity (bit 6), normal (bit 7), subnormal (bit 8), and zero (bit 9).

This instruction corresponds to the **class** operation of the IEEE Standard for Floating-Point Arithmetic 754TM-2008. This scalar FPU instruction also corresponds to the vector FCLASS.df instruction of MSA.

The input values and generated bit masks are not affected by the flush-subnormal-to-zero mode FCSR.FS.

The input operand is a scalar value in floating-point data format *fmt*. Bits beyond the width of *fmt* are ignored. The result is a 10-bit bitmask as described above, zero extended to *fmt*-width bits. Coprocessor register bits beyond *fmt*-width bits are UNPREDICTABLE (e.g., for CLASS.S bits 32-63 are UNPREDICTABLE on a 64-bit FPU, while bits 32-128 bits are UNPREDICTABLE if the processor supports MSA).

Restrictions:

No data-dependent exceptions are possible.

Availability and Compatibility:

This instruction is introduced by and required as of Release 6.

CLASS.fmt is defined only for formats S and D. Other formats must produce a Reserved Instruction exception (unless used for a different instruction).

Operation:

```

if not IsCoprocessorEnabled(1)
  then SignalException(CoprocessorUnusable, 1) endif
if not IsFloatingPointImplemented(fmt)
  then SignalException(ReservedInstruction) endif

fin ← ValueFPR(fs, fmt)
masktmp ← ClassFP(fin, fmt)
StoreFPR (fd, fmt, tmp)
/* end of instruction */

function ClassFP(tt, ts, n)
/* Implementation defined class operation. */
endfunction ClassFP

```

Exceptions:

Coprocessor Unusable, Reserved Instruction

Floating Point Exceptions:

Unimplemented Operation

pre-Release 6

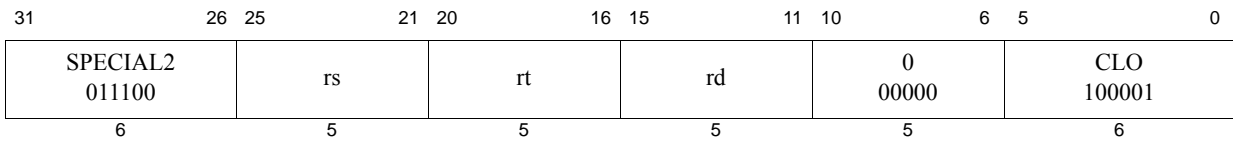

Release 6

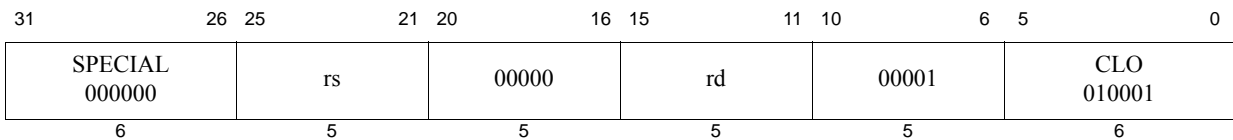
**Format:** CLO rd, rs**MIPS32****Purpose:** Count Leading Ones in Word

To count the number of leading ones in a word.

Description: $GPR[rd] \leftarrow \text{count_leading_ones } GPR[rs]$ Bits 31..0 of GPR *rs* are scanned from most significant to least significant bit. The number of leading ones is counted and the result is written to GPR *rd*. If all of bits **31..0** were set in GPR *rs*, the result written to GPR *rd* is 32.**Restrictions:**Pre-Release 6: To be compliant with the MIPS32Architecture, software must place the same GPR number in both the *rt* and *rd* fields of the instruction. The operation of the instruction is **UNPREDICTABLE** if the *rt* and *rd* fields of the instruction contain different values. Release 6's new instruction encoding does not contain an *rt* field.**Availability and Compatibility:**

This instruction has been recoded for Release 6.

Operation:

```

temp ← 32
for i in 31 .. 0
  if GPR[rs]i = 0 then
    temp ← 31 - i
    break
  endif
endfor
GPR[rd] ← temp

```

Exceptions:

None

Programming Notes:

As shown in the instruction drawing above, the Release 6 architecture sets the 'rt' field to a value of 00000.

pre-Release 6

31	26 25	21 20	16 15	11 10	6 5	0
SPECIAL2 011100	rs	rt	rd	0 00000	CLZ 100000	
6	5	5	5	5	6	

Release 6

31	26 25	21 20	16 15	11 10	6 5	0
SPECIAL 000000	rs	00000	rd	00001	CLZ 010000	
6	5	5	5	5	6	

Format: CLZ rd, rs**MIPS32****Purpose:** Count Leading Zeros in Word

Count the number of leading zeros in a word.

Description: $\text{GPR}[rd] \leftarrow \text{count_leading_zeros } \text{GPR}[rs]$

Bits **31..0** of GPR *rs* are scanned from most significant to least significant bit. The number of leading zeros is counted and the result is written to GPR *rd*. If no bits were set in GPR *rs*, the result written to GPR *rd* is 32.

Restrictions:

Pre-Release 6: To be compliant with the MIPS32 Architecture, software must place the same GPR number in both the *rt* and *rd* fields of the instruction. The operation of the instruction is **UNPREDICTABLE** if the *rt* and *rd* fields of the instruction contain different values. Release 6's new instruction encoding does not contain an *rt* field.

Availability and Compatibility:

This instruction has been recoded for Release 6.

Operation:

```
temp ← 32
for i in 31 .. 0
  if GPR[rs]i = 1 then
    temp ← 31 - i
    break
  endif
endfor
GPR[rd] ← temp
```

Exceptions:

None

Programming Notes:

Release 6 sets the 'rt' field to a value of 00000.

31	26 25	21 20	16 15	11 10	6 5 4	0
COP1 010001	CMP.condn.S 10100	ft	fs	fd	0	condn
COP1 010001	CMP.condn.D 10101	ft	fs	fd	0	condn
6	5	5	5	5	1	5

Format: `CMP.condn.fmt`
`CMP.condn.S fd, fs, ft`
`CMP.condn.D fd, fs, ft`

MIPS32 Release 6
MIPS32 Release 6

Purpose: Floating Point Compare Setting Mask

To compare FP values and record the result as a format-width mask of all 0s or all 1s in a floating point register

Description: $FPR[fd] \leftarrow FPR[fs] \text{ compare_cond } FPR[ft]$

The value in `FPR fs` is compared to the value in `FPR ft`.

The comparison is exact and neither overflows nor underflows.

If the comparison specified by the `condn` field of the instruction is true for the operand values, the result is true; otherwise, the result is false. If no exception is taken, the result is written into `FPR fd`; true is all 1s and false is all 0s, repeated the operand width of `fmt`. All other bits beyond the operand width `fmt` are UNPREDICTABLE. For example, a 32-bit single precision comparison writes a mask of 32 0s or 1s into bits 0 to 31 of `FPR fd`. It makes bits 32 to 63 UNPREDICTABLE if a 64-bit FPU without MSA is present. It makes bits 32 to 127 UNPREDICTABLE if MSA is present.

The values are in format `fmt`. These instructions, however, do not use an `fmt` field to determine the data type.

The `condn` field of the instruction specifies the nature of the comparison: equals, less than, and so on, unordered or ordered, signalling or quiet, as specified in [Table 3.9 “Comparing CMP.condn.fmt, IEEE 754-2008, C.cond.fmt, and MSA FP compares” on page 136](#).

Release 6: The `condn` field bits have specific purposes: `cond4` and `cond2..1` specify the nature of the comparison (equals, less than, and so on); `cond0` specifies whether the comparison is ordered or unordered, that is false or true if any operand is a NaN; `cond3` indicates whether the instruction should signal an exception on QNaN inputs. However, in the future the MIPS ISA may be extended in ways that do not preserve these meanings.

All encodings of the `condn` field that are not specified (for example, items shaded in [Table 3.9](#)) are reserved in Release 6 and produce a Reserved Instruction exception.

If one of the values is an SNaN, or if a signalling comparison is specified and at least one of the values is a QNaN, an Invalid Operation condition is raised and the Invalid Operation flag is set in the `FCSR`. If the Invalid Operation `Enable` bit is set in the `FCSR`, no result is written and an Invalid Operation exception is taken immediately. Otherwise, the mask result is written into `FPR fd`.

There are four mutually exclusive ordering relations for comparing floating point values; one relation is always true and the others are false. The familiar relations are *greater than*, *less than*, and *equal*. In addition, the IEEE floating point standard defines the relation *unordered*, which is true when at least one operand value is NaN; NaN compares unordered with everything, including itself. Comparisons ignore the sign of zero, so +0 equals -0.

The comparison condition is a logical predicate, or equation, of the ordering relations such as *less than or equal*, *equal*, *not less than*, or *unordered or equal*. Compare distinguishes among the 16 comparison predicates. The Boolean result of the instruction is obtained by substituting the Boolean value of each ordering relation for the two FP values in the equation. For example: If the *equal* relation is true, then all four example predicates above yield a true result. If the *unordered* relation is true then only the final predicate, *unordered or equal*, yields a true result.

The predicates implemented are described in [Table 3.9 “Comparing CMP.condn.fmt, IEEE 754-2008, C.cond.fmt, and MSA FP compares” on page 136](#). Not all of the 16 IEEE predicates are implemented directly by hardware. For the directed comparisons (LT, LE, GT, GE) the missing predicates can be obtained by reversing the FPR register operands ft and fs . For example, the hardware implements the “Ordered Less Than” predicate $LT(fs,ft)$; reversing the operands $LT(ft,fs)$ produces the dual predicate “Unordered or Greater Than or Equal” $UGE(fs,ft)$. [Table 3.9](#) shows these mappings. Reversing inputs is ineffective for the symmetric predicates such as EQ; Release 6 implements these negative predicates directly, so that all mask values can be generated in a single instruction.

[Table 3.9](#) compares CMP.condn.fmt to (1) the MIPS32 Pre-Release 6 C.cond.fmt instructions, and (2) the (MSA) MIPS SIMD Architecture packed vector floating point comparison instructions. CMP.condn.fmt provides exactly the same comparisons for FPU scalar values that MSA provides for packed vectors, with similar mnemonics. CMP.condn.fmt provides a superset of the MIPS32 Release 5 C.cond.fmt comparisons.

In addition, [Table 3.9](#) shows the corresponding IEEE 754-2008 comparison operations.

Table 3.9 Comparing CMP.condn.fmt, IEEE 754-2008, C.cond.fmt, and MSA FP compares

Shaded entries in the table are unimplemented, and reserved.

Instruction Encodings																				
Invalid Operand Exception		CMP.condn.fmt: 010001 fffff ttttt sssss dddd 0cccc C.cond.fmt: 010001 fffff ttttt sssss CCC0 11cccc MSA: 011110 000of ttttt sssss dddd mmmmmmm																		
		MSA: minor opcode mmmmmmm Bits 5...0 = 26 - 011010 CMP: condn Bit 5.4 = 00 C: only applicable								MSA: minor opcode mmmmmmm Bits 5...0 = 28 - 011100 CMP: condn Bit 5.4 = 01 C: not applicable										
		Predicates								Negated Predicates										
no (non-signalling) yes (always signal SNaN)		Relation				C condn.fmt	MSA	CMP condn.fmt	Long names	IEEE	Relation				C condn.fmt	MSA	CMP condn.fmt	Long names	IEEE	
		>	<	=	?						>	<	=	?						
	0	0000	F	F	F	F	F	FCAF	AF	False Always False		T	T	T	T	T	AT	True Always True		
	1	0001	F	F	F	T	UN	FCUN	UN	Unordered	compareQuietUnordered? isUnordered	T	T	T	F	OR	FCOR	OR	Ordered	compareQuietOrdered <<> NOT(isUnordered)
	2	0010	F	F	T	F	EQ	FCEQ	EQ	Equal	compareQuietEqual =	T	T	F	T	NEQ	FCUNE	UNE	Not Equal	compareQuietNotEqual ?<>, NOT(=), ≠
	3	0011	F	F	T	T	UEQ	FCUEQ	UEQ	Unordered or Equal		T	T	F	F	OGL	FCNE	NE	Ordered Greater Than or Less Than	
	4	0100	F	T	F	F	OLT	FCLT	LT	Ordered Less Than	compareQuietLess isLess	T	F	T	T	UGE		UGE	Unordered or Greater Than or Equal	compareQuietNotLess ?>=, NOT(isLess)
	5	0101	F	T	F	T	ULT	FCULT	ULT	Unordered or Less Than	compareQuietLessUnor- dered ?<, NOT(isGreaterEqual)	T	F	T	F	OGE		OGE	Ordered Greater Than or Equal	compareQuiet- GreatrEqual isGreaterEqual
	6	0110	F	T	T	F	OLE	FCLE	LE	Ordered Less than or Equal	compareQuietLessEqual isLessEqual	T	F	F	T	UGT		UGT	Unordered or Greater Than	compareQuietGreaterUn- ordered ?>, NOT(isLessEqual)
	7	0111	F	T	T	T	ULE	FCULE	ULE	Unordered or Less Than or Equal	compareQuietNotGreater ?<<=, NOT(isGreater)	T	F	F	F	OGT		OGT	Ordered Greater Than	compareQuietGreater isGreater

Table 3.9 Comparing CMP.condn.fmt, IEEE 754-2008, C.cond.fmt, and MSA FP compares (Continued)

Shaded entries in the table are unimplemented, and reserved.

Instruction Encodings																				
		CMP.condn.fmt: 010001 fffff ttttt sssss dddd 0cccc					C.cond.fmt: 010001 fffff ttttt sssss CCC00 1lcccc					MSA: 011110 oooof ttttt sssss dddd mmmmm								
		MSA: minor opcode mmmmm Bits 5...0 = 26 - 011010 CMP: condn Bit 5.4 = 00 C: only applicable					MSA: minor opcode mmmmm Bits 5...0 = 28 - 011100 CMP: condn Bit 5.4 = 01 C: not applicable													
Invalid Operand Exception	MSA: operation oooo Bits 25...22 C: cond cccc - Bits 3..0 CMP: condn cccc - Bits 3..0	Predicates							Negated Predicates											
		Relation				condn.fmt	MSA	CMP condn.fmt	Long names	IEEE	Relation				condn.fmt	MSA	CMP condn.fmt	Long names	IEEE	
		>	<	=	?	C					>	<	=	?	C					
yes (signalling)	8	1000	F	F	F	F	SF	FSAF	SAF	Signalling False Signalling Always False		T	T	T	T	ST		SAT	Signalling True Signalling Always True	
	9	1001	F	F	F	T	NGLE	FSUN	SUN	Not Greater Than or Less Than or Equal Signalling Unordered		T	T	T	F	GLE	FSOR	SOR	Greater Than or Less Than or Equal Signalling Ordered	
	10	1010	F	F	T	F	SEQ	FSEQ	SEQ	Signalling Equal Ordered Signalling Equal	compareSignalling Equal	T	T	F	T	SNE	FSUNE	SUNE	Signalling Not Equal Signalling Unordered or Not Equal	compareSignalling-NotEqual
	11	1011	F	F	T	T	NGL	FSUEQ	SUEQ	Not Greater Than or Less Than Signalling Unordered or Equal		T	T	F	F	GL	FSNE	SNE	Greater Than or Less Than Signalling Ordered Not Equal	
	12	1100	F	T	F	F	LT	FSLT	SLT	Less Than Ordered Signalling Less Than	compareSignallingLess <	T	F	T	T	NLT		SUGE	Not Less Than Signalling Unordered or Greater Than or Equal	compareSignallingNot-Less NOT(<)
	13	1101	F	T	F	T	NGE	FSULT	SULT	Not Greater Than or Equal Unordered or Less Than	compareSignalling-LessUnordered NOT(>=)	T	F	T	F	GE		SOGE	Signalling Ordered Greater Than or Equal	compareSignalling-GreaterEqual >=, >
	14	1110	F	T	T	F	LE	FSLE	SLE	Less Than or Equal Ordered Signalling Less Than or Equal	compareSignalling-LessEqual <=, <=	T	F	F	T	NLE		SUGT	Not Less Than or Equal Signalling Unordered or Greater Than	compareSignalling-GreaterUnordered NOT(<=)
	15	1111	F	T	T	T	NGT	FSULE	SULE	Not Greater Than Signalling Unordered or Less Than or Equal	compareSignalling-NotGreater NOT(>)	T	F	F	F	GT		SOGT	Greater Than Signalling Ordered Greater Than	compareSignalling-Greater >

Restrictions:**Operation:**

```

if SNaN(ValueFPR(fs, fmt)) or SNaN(ValueFPR(ft, fmt)) or
   QNaN(ValueFPR(fs, fmt)) or QNaN(ValueFPR(ft, fmt))
then
  less ← false
  equal ← false
  unordered ← true
  if (SNaN(ValueFPR(fs,fmt)) or SNaN(ValueFPR(ft,fmt))) or
     (cond3 and (QNaN(ValueFPR(fs,fmt)) or QNaN(ValueFPR(ft,fmt)))) then
    SignalException(InvalidOperation)
  endif
else
  less ← ValueFPR(fs, fmt) <fmt ValueFPR(ft, fmt)
  equal ← ValueFPR(fs, fmt) =fmt ValueFPR(ft, fmt)
  unordered ← false
endif
condition ← cond4 xor (
  (cond2 and less)
  or (cond1 and equal)
  or (cond0 and unordered) )
StoreFPR (fd, fmt, ExtendBit.fmt(condition))

```

Exceptions:

Coprocessor Unusable, Reserved Instruction

Floating Point Exceptions:

Unimplemented Operation, Invalid Operation

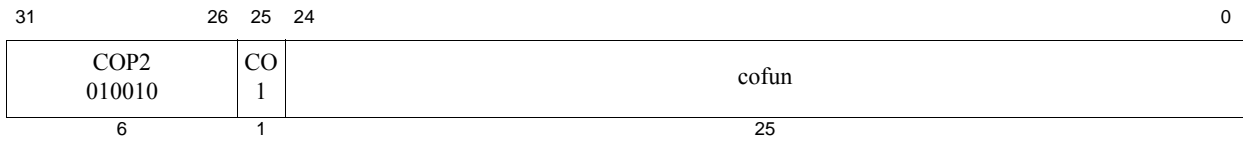

Format: COP2 func

MIPS32

Purpose: Coprocessor Operation to Coprocessor 2

To perform an operation to Coprocessor 2.

Description: `CoprocessorOperation(2, cofun)`

An implementation-dependent operation is performed to Coprocessor 2, with the *cofun* value passed as an argument. The operation may specify and reference internal coprocessor registers, and may change the state of the coprocessor conditions, but does not modify state within the processor. Details of coprocessor operation and internal state are described in the documentation for each Coprocessor 2 implementation.

Restrictions:

Operation:

`CoprocessorOperation(2, cofun)`

Exceptions:

Coprocessor Unusable, Reserved Instruction

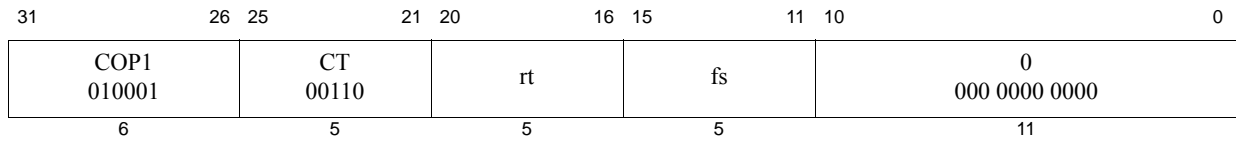

Format: CTC1 rt, fs

MIPS32

Purpose: Move Control Word to Floating Point

To copy a word from a GPR to an FPU control register.

Description: $FP_Control[fs] \leftarrow GPR[rt]$

Copy the low word from GPR *rt* into the FP (coprocessor 1) control register indicated by *fs*.

Writing to the floating point *Control/Status* register, the *FCSR*, causes the appropriate exception if any *Cause* bit and its corresponding *Enable* bit are both set. The register is written before the exception occurs. Writing to *FEXR* to set a cause bit whose enable bit is already set, or writing to *FENR* to set an enable bit whose cause bit is already set causes the appropriate exception. The register is written before the exception occurs and the *EPC* register contains the address of the CTC1 instruction.

The definition of this instruction has been extended in Release 5 to support user mode read and write of *Status_{FR}* under the control of *Config5_{UFR}*. This optional feature is meant to facilitate transition from *FR=0* to *FR=1* floating-point register modes in order to obsolete *FR=0* mode in a future architecture release. User code may set and clear *Status_{FR}* without kernel intervention, providing kernel explicitly provides permission.

This UFR facility is not supported in Release 6 since Release 6 only allows *FR=1* mode. Accessing the UFR and UNFR registers causes a Reserved Instruction exception in Release 6 since *FIR_{UFRP}* is always 0.

The definition of this instruction has been extended in Release 6 to allow user code to read and modify the *Config5_{FRE}* bit. Such modification is allowed when this bit is present (as indicated by *FIR_{UFRP}*) and user mode modification of the bit is enabled by the kernel (as indicated by *Config5_{UFE}*). Setting *Config5_{FRE}* to 1 causes all floating point instructions which are not compatible with *FR=1* mode to take an Reserved Instruction exception. This makes it possible to run pre-Release 6 *FR=0* floating point code on a Release 6 core which only supports *FR=1* mode, provided the kernel has been set up to trap and emulate *FR=0* behavior for these instructions. These instructions include floating-point arithmetic instructions that read/write single-precision registers, LWC1, SWC1, MTC1, and MFC1 instructions.

The FRE facility uses COP1 register aliases FRE and NFRE to access *Config5_{FRE}*.

Restrictions:

There are a few control registers defined for the floating point unit. Prior to Release 6, the result is **UNPREDICTABLE** if *fs* specifies a register that does not exist. In Release 6 and later, a Reserved Instruction exception occurs if *fs* specifies a register that does not exist.

Furthermore, the result is **UNPREDICTABLE** if *fd* specifies the UFR, UNFR, FRE and NFRE aliases, with *fs* anything other than 00000, GPR[0]. Release 6 implementations and later are required to produce a Reserved Instruction exception; software must assume it is **UNPREDICTABLE**.

Operation:

```
temp ← GPR[rt]31..0
if (fs = 1 or fs = 4) then
    /* clear UFR or UNFR(CP1 Register 1)*/
    if ConfigAR ≥ 2 SignalException(ReservedInstruction) /* Release 6 traps */ endif
```

```

    if not Config5UFR then SignalException(ReservedInstruction) endif
    if not (rt = 0 and FIRUFRP) then UNPREDICTABLE /*end of instruction*/ endif
    if fs = 1 then StatusFR ← 0
    elseif fs = 4 then StatusFR ← 1
    else /* cannot happen */
elseif fs=5 then /* user write of 1 to FRE, if permitted */
    if ConfigAR ≤ 2 then UNPREDICTABLE
    else
        if rt ≠ 0 then SignalException(ReservedInstruction) endif
        if not Config5UFR then SignalException(ReservedInstruction) endif
        Config5UFR ← 0
    endif
elseif fs=6 then /* user write of 0 to FRE, if permitted (NFRE alias) */
    if ConfigAR ≤ 2 then UNPREDICTABLE
    else
        if rt ≠ 0 then SignalException(ReservedInstruction) endif
        if not Config5UFR then SignalException(ReservedInstruction) endif
        Config5UFR ← 1
    endif
elseif fs = 25 then /* FCCR */
    if temp31..8 ≠ 024 then
        UNPREDICTABLE
    else
        FCSR ← temp7..1 || FCSR24 || temp0 || FCSR22..0
    endif
elseif fs = 26 then /* FEXR */
    if temp31..18 ≠ 0 or temp11..7 ≠ 0 or temp2..0 ≠ 0 then
        UNPREDICTABLE
    else
        FCSR ← FCSR31..18 || temp17..12 || FCSR11..7 ||
            temp6..2 || FCSR1..0
    endif
elseif fs = 28 then /* FENR */
    if temp31..12 ≠ 0 or temp6..3 ≠ 0 then
        UNPREDICTABLE
    else
        FCSR ← FCSR31..25 || temp2 || FCSR23..12 || temp11..7
            || FCSR6..2 || temp1..0
    endif
elseif fs = 31 then /* FCSR */
    if (FCSRImpl field is not implemented) and(temp22..18 ≠ 0) then
        UNPREDICTABLE
    elseif (FCSRImpl field is implemented) and temp20..18 ≠ 0 then
        UNPREDICTABLE
    else
        FCSR ← temp
    endif
else
    if Config2AR ≥ 2 SignalException(ReservedInstruction) /* Release 6 traps */
    endif
    UNPREDICTABLE
endif
CheckFPException()

```

Exceptions:

Coprocessor Unusable, Reserved Instruction

Floating Point Exceptions:

Unimplemented Operation, Invalid Operation, Division-by-zero, Inexact, Overflow, Underflow

Historical Information:

For the MIPS I, II and III architectures, the contents of floating point control register *fs* are **UNPREDICTABLE** for the instruction immediately following CTC1.

MIPS V and MIPS32 introduced the three control registers that access portions of *FCSR*. These registers were not available in MIPS I, II, III, or IV.

MIPS32 Release 5 introduced the UFR and UNFR register aliases that allow user level access to *Status_{FR}*.

MIPS32 Release 6 introduced the FRE and NFRE register aliases that allow user to cause traps for *FR=0* mode emulation.

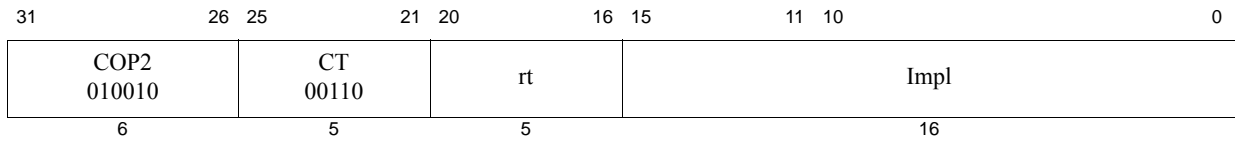

Format: CTC2 *rt*, *Impl*

MIPS32

The syntax shown above is an example using CTC1 as a model. The specific syntax is implementation dependent.

Purpose: Move Control Word to Coprocessor 2

To copy a word from a GPR to a Coprocessor 2 control register.

Description: $CP2CCR[Impl] \leftarrow GPR[rt]$

Copy the low word from GPR *rt* into the Coprocessor 2 control register denoted by the *Impl* field. The interpretation of the *Impl* field is left entirely to the Coprocessor 2 implementation and is not specified by the architecture.

Restrictions:

The result is **UNPREDICTABLE** if *rd* specifies a register that does not exist.

Operation:

```
temp ← GPR[rt]
CP2CCR[Impl] ← temp
```

Exceptions:

Coprocessor Unusable, Reserved Instruction

31	26 25	21 20	16 15	11 10	6 5	0
COP1 010001	fmt	0 00000	fs	fd	CVT.D 100001	
6	5	5	5	5	6	

Format: CVT.D.fmt
 CVT.D.S fd, fs
 CVT.D.W fd, fs
 CVT.D.L fd, fs

MIPS32
MIPS32
MIPS32 Release 2

Purpose: Floating Point Convert to Double Floating Point

To convert an FP or fixed point value to double FP.

Description: $FPR[fd] \leftarrow \text{convert_and_round}(FPR[fs])$

The value in FPR *fs*, in format *fmt*, is converted to a value in double floating point format and rounded according to the current rounding mode in *FCSR*. The result is placed in FPR *fd*. If *fmt* is S or W, then the operation is always exact.

Restrictions:

The fields *fs* and *fd* must specify valid FPRs, *fs* for type *fmt* and *fd* for double floating point. If the fields are not valid, the result is **UNPREDICTABLE**.

The operand must be a value in format *fmt*; if it is not, the result is **UNPREDICTABLE** and the value of the operand FPR becomes **UNPREDICTABLE**.

For CVT.D.L, the result of this instruction is **UNPREDICTABLE** if the processor is executing in the *FR=0* 32-bit FPU register model.

Operation:

`StoreFPR (fd, D, ConvertFmt(ValueFPR(fs, fmt), fmt, D))`

Exceptions:

Coprocessor Unusable, Reserved Instruction

Floating Point Exceptions:

Invalid Operation, Unimplemented Operation, Inexact

31	26 25	21 20	16 15	11 10	6 5	0
COP1 010001	fmt	0 00000	fs	fd	CVT.L 100101	
6	5	5	5	5	6	

Format: CVT.L.fmt
 CVT.L.S fd, fs
 CVT.L.D fd, fs

MIPS32 Release 2
MIPS32 Release 2

Purpose: Floating Point Convert to Long Fixed Point

To convert an FP value to a 64-bit fixed point.

Description: $FPR[fd] \leftarrow \text{convert_and_round}(FPR[fs])$

Convert the value in format *fmt* in FPR *fs* to long fixed point format and round according to the current rounding mode in *FCSR*. The result is placed in FPR *fd*.

When the source value is Infinity, NaN, or rounds to an integer outside the range -2^{63} to $2^{63}-1$, the result cannot be represented correctly, an IEEE Invalid Operation condition exists, and the Invalid Operation flag is set in the *FCSR*. If the Invalid Operation *Enable* bit is set in the *FCSR*, no result is written to *fd* and an Invalid Operation exception is taken immediately. Otherwise, a default result is written to *fd*. On cores with $FCSR_{NAN2008}=0$, the default result is $2^{63}-1$. On cores with $FCSR_{NAN2008}=1$, the default result is:

- 0 when the input value is NaN
- $2^{63}-1$ when the input value is $+\infty$ or rounds to a number larger than $2^{63}-1$
- $-2^{63}-1$ when the input value is $-\infty$ or rounds to a number smaller than $-2^{63}-1$

Restrictions:

The fields *fs* and *fd* must specify valid FPRs, *fs* for type *fmt* and *fd* for long fixed point. If the fields are not valid, the result is **UNPREDICTABLE**.

The operand must be a value in format *fmt*; if it is not, the result is **UNPREDICTABLE** and the value of the operand FPR becomes **UNPREDICTABLE**.

The result of this instruction is **UNPREDICTABLE** if the processor is executing in the *FR=0* 32-bit FPU register model; it is predictable if executing on a 64-bit FPU in the *FR=1* mode, but not with *FR=0*, and not on a 32-bit FPU.

Operation:

StoreFPR (fd, L, ConvertFmt(ValueFPR(fs, fmt), fmt, L))

Exceptions:

Coprocessor Unusable, Reserved Instruction

Floating Point Exceptions:

Invalid Operation, Unimplemented Operation, Inexact,

31	26 25	21 20	16 15	11 10	6 5	0
COP1 010001	fmt 10000	ft	fs	fd	CVT.PS 100110	
6	5	5	5	5	6	

Format: CVT.PS.S *fd*, *fs*, *ft*

MIPS32 Release 2, removed in Release 6

Purpose: Floating Point Convert Pair to Paired Single

To convert two FP values to a paired single value.

Description: $FPR[fd] \leftarrow FPR[fs]_{31..0} \parallel FPR[ft]_{31..0}$

The single-precision values in FPR *fs* and *ft* are written into FPR *fd* as a paired-single value. The value in FPR *fs* is written into the upper half, and the value in FPR *ft* is written into the lower half.

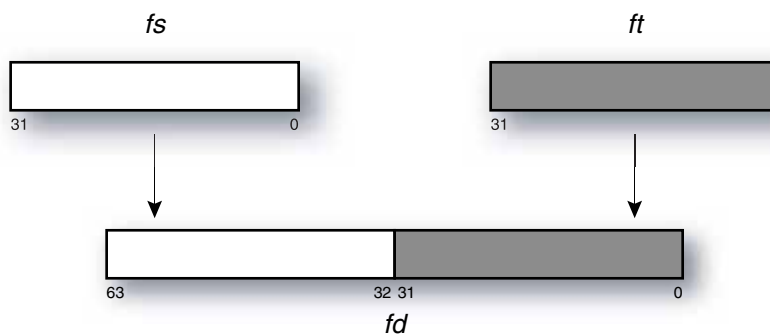

CVT.PS.S is similar to PLL.PS, except that it expects operands of format *S* instead of *PS*.

The move is non-arithmetic; it causes no IEEE 754 exceptions, and the $FCSR_{Cause}$ and $FCSR_{Flags}$ fields are not modified.

Restrictions:

The fields *fs* and *ft* must specify FPRs valid for operands of type *S*. If the fields are not valid, the result is **UNPREDICTABLE**.

The operand must be a value in format *S*; if it is not, the result is **UNPREDICTABLE** and the value of the operand FPR becomes **UNPREDICTABLE**.

The result of this instruction is **UNPREDICTABLE** if the processor is executing in the $FR=0$ 32-bit FPU register model; it is predictable if executing on a 64-bit FPU in the $FR=1$ mode, but not with $FR=0$, and not on a 32-bit FPU.

Availability and Compatibility:

This instruction has been removed in Release 6.

Operation:

$\text{StoreFPR}(fd, S, \text{ValueFPR}(fs, S) \parallel \text{ValueFPR}(ft, S))$

Exceptions:

Coprocessor Unusable, Reserved Instruction

Floating Point Exceptions:

Invalid Operation, Unimplemented Operation

31	26 25	21 20	16 15	11 10	6 5	0
COP1 010001	fmt 10110	0 00000	fs	fd	CVT.S.PL 101000	
6	5	5	5	5	6	

Format: CVT.S.PL *fd*, *fs*

MIPS32 Release 2, removed in Release 6

Purpose: Floating Point Convert Pair Lower to Single Floating Point

To convert one half of a paired single FP value to single FP.

Description: $FPR[fd] \leftarrow FPR[fs]_{31..0}$

The lower paired single value in FPR *fs*, in format *PS*, is converted to a value in single floating point format. The result is placed in FPR *fd*. This instruction can be used to isolate the lower half of a paired single value.

The operation is non-arithmetic; it causes no IEEE 754 exceptions, and the *FCSR_{Cause}* and *FCSR_{Flags}* fields are not modified.

Restrictions:

The fields *fs* and *fd* must specify valid FPRs—*fs* for type *PS* and *fd* for single floating point. If the fields are not valid, the result is **UNPREDICTABLE**.

The operand must be a value in format *PS*; if it is not, the result is **UNPREDICTABLE** and the value of the operand FPR becomes **UNPREDICTABLE**.

The result of CVT.S.PL is **UNPREDICTABLE** if the processor is executing in the *FR*=0 32-bit FPU register model; it is predictable if executing on a 64-bit FPU in the *FR*=1 mode, but not with *FR*=0, and not on a 32-bit FPU.

Availability and Compatibility:

This instruction has been removed in Release 6.

Operation:

`StoreFPR (fd, S, ConvertFmt(ValueFPR(fs, PS), PL, S))`

Exceptions:

Coprocessor Unusable, Reserved Instruction

Floating Point Exceptions:

31	26 25	21 20	16 15	11 10	6 5	0
COP1 010001	fmt 10110	0 00000	fs	fd	CVT.S.PU 100000	
6	5	5	5	5	6	

Format: CVT.S.PU *fd*, *fs*

MIPS32 Release 2, , removed in Release 6

Purpose: Floating Point Convert Pair Upper to Single Floating Point

To convert one half of a paired single FP value to single FP

Description: $FPR[fd] \leftarrow FPR[fs]_{63..32}$

The upper paired single value in FPR *fs*, in format *PS*, is converted to a value in single floating point format. The result is placed in FPR *fd*. This instruction can be used to isolate the upper half of a paired single value.

The operation is non-arithmetic; it causes no IEEE 754 exceptions, and the $FCSR_{Cause}$ and $FCSR_{Flags}$ fields are not modified.

Restrictions:

The fields *fs* and *fd* must specify valid FPRs—*fs* for type *PS* and *fd* for single floating point. If the fields are not valid, the result is **UNPREDICTABLE**.

The operand must be a value in format *PS*; if it is not, the result is **UNPREDICTABLE** and the value of the operand FPR becomes **UNPREDICTABLE**.

The result of CVT.S.PU is **UNPREDICTABLE** if the processor is executing the $FR=0$ 32-bit FPU register model; it is predictable if executing on a 64-bit FPU in the $FR=1$ mode, but not with $FR=0$, and not on a 32-bit FPU

Availability and Compatibility:

This instruction was removed in Release 6.

Operation:

$\text{StoreFPR}(fd, S, \text{ConvertFmt}(\text{ValueFPR}(fs, PS), PU, S))$

Exceptions:

Coprocessor Unusable, Reserved Instruction

Floating Point Exceptions:

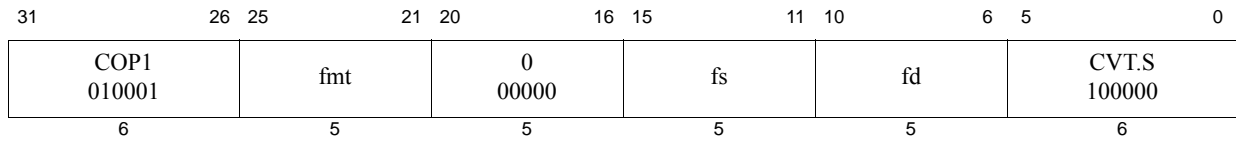

Format: CVT.S.fmt
 CVT.S.D fd, fs
 CVT.S.W fd, fs
 CVT.S.L fd, fs

MIPS32
MIPS32
MIPS32 Release 2

Purpose: Floating Point Convert to Single Floating Point

To convert an FP or fixed point value to single FP.

Description: $FPR[fd] \leftarrow \text{convert_and_round}(FPR[fs])$

The value in FPR *fs*, in format *fmt*, is converted to a value in single floating point format and rounded according to the current rounding mode in *FCSR*. The result is placed in FPR *fd*.

Restrictions:

The fields *fs* and *fd* must specify valid FPRs—*fs* for type *fmt* and *fd* for single floating point. If the fields are not valid, the result is **UNPREDICTABLE**.

The operand must be a value in format *fmt*; if it is not, the result is **UNPREDICTABLE** and the value of the operand FPR becomes **UNPREDICTABLE**.

For CVT.S.L, the result of this instruction is **UNPREDICTABLE** if the processor is executing in the *FR*=0 32-bit FPU register model; it is predictable if executing on a 64-bit FPU in the *FR*=1 mode, but not with *FR*=0, and not on a 32-bit FPU.

Operation:

`StoreFPR(fd, S, ConvertFmt(ValueFPR(fs, fmt), fmt, S))`

Exceptions:

Coprocessor Unusable, Reserved Instruction

Floating Point Exceptions:

Invalid Operation, Unimplemented Operation, Inexact, Overflow, Underflow

31	26 25	21 20	16 15	11 10	6 5	0
COP1 010001	fmt	0 00000	fs	fd	CVT.W 100100	
6	5	5	5	5	6	

Format: CVT.W.fmt
 CVT.W.S fd, fs
 CVT.W.D fd, fs

MIPS32
MIPS32

Purpose: Floating Point Convert to Word Fixed Point

To convert an FP value to 32-bit fixed point.

Description: $FPR[fd] \leftarrow \text{convert_and_round}(FPR[fs])$

The value in FPR *fs*, in format *fmt*, is converted to a value in 32-bit word fixed point format and rounded according to the current rounding mode in *FCSR*. The result is placed in FPR *fd*.

When the source value is Infinity, NaN, or rounds to an integer outside the range -2^{31} to $2^{31}-1$, the result cannot be represented correctly, an IEEE Invalid Operation condition exists, and the Invalid Operation flag is set in the *FCSR*. If the Invalid Operation *Enable* bit is set in the *FCSR*, no result is written to *fd* and an Invalid Operation exception is taken immediately. Otherwise, a default result is written to *fd*. On cores with $FCSR_{NAN2008}=0$, the default result is $2^{63}-1$. On cores with $FCSR_{NAN2008}=1$, the default result is:

- 0 when the input value is NaN
- $2^{63}-1$ when the input value is $+\infty$ or rounds to a number larger than $2^{63}-1$
- $-2^{63}-1$ when the input value is $-\infty$ or rounds to a number smaller than $-2^{63}-1$

Restrictions:

The fields *fs* and *fd* must specify valid FPRs: *fs* for type *fmt* and *fd* for word fixed point. If the fields are not valid, the result is **UNPREDICTABLE**.

The operand must be a value in format *fmt*; if it is not, the result is **UNPREDICTABLE** and the value of the operand FPR becomes **UNPREDICTABLE**.

Operation:

$\text{StoreFPR}(fd, W, \text{ConvertFmt}(\text{ValueFPR}(fs, fmt), fmt, W))$

Exceptions:

Coprocessor Unusable, Reserved Instruction

Floating Point Exceptions:

Invalid Operation, Unimplemented Operation, Inexact

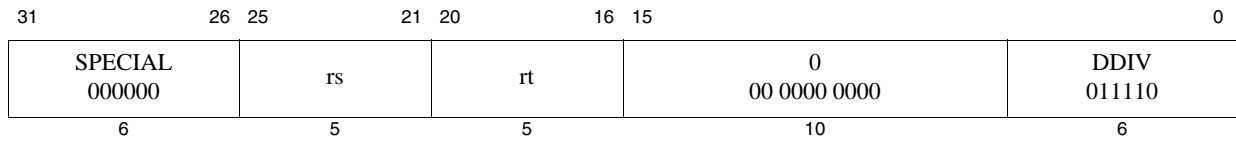

Format: DDIV *rs*, *rt*

MIPS64, removed in Release 6

Purpose: Doubleword Divide

To divide 64-bit signed integers.

Description: $(LO, HI) \leftarrow GPR[rs] / GPR[rt]$

The 64-bit doubleword in GPR *rs* is divided by the 64-bit doubleword in GPR *rt*, treating both operands as signed values. The 64-bit quotient is placed into special register *LO* and the 64-bit remainder is placed into special register *HI*.

No arithmetic exception occurs under any circumstances.

Restrictions:

If the divisor in GPR *rt* is zero, the arithmetic result value is **UNPREDICTABLE**.

Availability and Compatibility:

This instruction has been removed in Release 6.

Operation:

```
LO ← GPR[rs] div GPR[rt]
HI ← GPR[rs] mod GPR[rt]
```

Exceptions:

Reserved Instruction

Programming Notes:

See “Programming Notes” for the DIV instruction.

Historical Perspective:

In MIPS III, if either of the two instructions preceding the divide is an MFHI or MFLO, the result of the MFHI or MFLO is **UNPREDICTABLE**. Reads of the *HI* or *LO* special register must be separated from subsequent instructions that write to them by two or more instructions. This restriction was removed in MIPS IV and MIPS32 and all subsequent levels of the architecture.

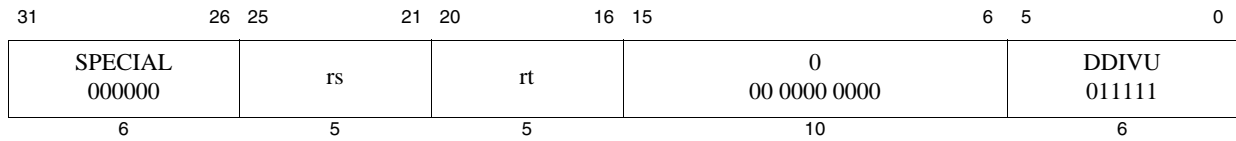

Format: DDIVU *rs*, *rt*

MIPS64, removed in Release 6

Purpose: Doubleword Divide Unsigned

To divide 64-bit unsigned integers.

Description: $(LO, HI) \leftarrow GPR[rs] / GPR[rt]$

The 64-bit doubleword in GPR *rs* is divided by the 64-bit doubleword in GPR *rt*, treating both operands as unsigned values. The 64-bit quotient is placed into special register *LO* and the 64-bit remainder is placed into special register *HI*.

No arithmetic exception occurs under any circumstances.

Restrictions:

If the divisor in GPR *rt* is zero, the arithmetic result value is **UNPREDICTABLE**.

Availability and Compatibility:

This instruction has been removed in Release 6.

Operation:

$$\begin{aligned}
 q &\leftarrow (0 \parallel GPR[rs]) \operatorname{div} (0 \parallel GPR[rt]) \\
 r &\leftarrow (0 \parallel GPR[rs]) \operatorname{mod} (0 \parallel GPR[rt]) \\
 LO &\leftarrow q_{63..0} \\
 HI &\leftarrow r_{63..0}
 \end{aligned}$$

Exceptions:

Reserved Instruction

Programming Notes:

See “Programming Notes” for the DIV instruction.

Historical Perspective:

In MIPS III, if either of the two instructions preceding the divide is an MFHI or MFLO, the result of the MFHI or MFLO is **UNPREDICTABLE**. Reads of the *HI* or *LO* special register must be separated from subsequent instructions that write to them by two or more instructions. This restriction was removed in MIPS IV and MIPS32 and all subsequent levels of the architecture.

31	26	25	24	6	5	0
COP0 010000	CO 1	0 000 0000 0000 0000 0000			DERET 011111	
6	1	19			6	

Format: DERET

EJTAG

Purpose: Debug Exception Return

To Return from a debug exception.

Description:

DERET clears execution and instruction hazards, returns from Debug Mode and resumes non-debug execution at the instruction whose address is contained in the *DEPC* register. DERET does not execute the next instruction (i.e. it has no delay slot).

Restrictions:

A DERET placed between an LL and SC instruction does not cause the SC to fail.

If the *DEPC* register with the return address for the DERET was modified by an MTC0 or a DMTC0 instruction, a CP0 hazard exists that must be removed via software insertion of the appropriate number of SSNOP instructions (for implementations of Release 1 of the Architecture) or by an EHB, or other execution hazard clearing instruction (for implementations of Release 2 of the Architecture).

DERET implements a software barrier that resolves all execution and instruction hazards created by Coprocessor 0 state changes (for Release 2 implementations, refer to the SYNCI instruction for additional information on resolving instruction hazards created by writing the instruction stream). The effects of this barrier are seen starting with the instruction fetch and decode of the instruction at the PC to which the DERET returns.

This instruction is legal only if the processor is executing in Debug Mode.

Pre-Release 6: The operation of the processor is **UNDEFINED** if a DERET is executed in the delay slot of a branch or jump instruction.

Release 6 implementations are required to signal a Reserved Instruction exception if DERET is encountered in the delay slot or forbidden slot of a branch or jump instruction.

Operation:

```

DebugDM ← 0
DebugTEXI ← 0
if IsMIPS16Implemented() | (Config3ISA > 0) then
    PC ← DEPC31..1 || 0
    ISAMode ← DEPC0
else
    PC ← DEPC
endif
ClearHazards()

```

Exceptions:

Coprocessor Unusable, Reserved Instruction

31	26 25	21 20	16 15	11 10	6 5	4 3	2	0
COP0 0100 00	MFMC0 01 011	rt	12 0110 0	0 000 00	sc 0	0 0 0	0 000	0
6	5	5	5	5	1	2	3	

Format: DI
DI rt

MIPS32 Release 2
MIPS32 Release 2

Purpose: Disable Interrupts

To return the previous value of the *Status* register and disable interrupts. If DI is specified without an argument, GPR r0 is implied, which discards the previous value of the *Status* register.

Description: $GPR[rt] \leftarrow Status$; $Status_{IE} \leftarrow 0$

The current value of the *Status* register is loaded into general register *rt*. The Interrupt Enable (IE) bit in the *Status* register is then cleared.

Restrictions:

If access to Coprocessor 0 is not enabled, a Coprocessor Unusable Exception is signaled.

In implementations prior to Release 2 of the architecture, this instruction resulted in a Reserved Instruction exception.

Operation:

This operation specification is for the general interrupt enable/disable operation, with the *sc* field as a variable. The individual instructions DI and EI have a specific value for the *sc* field.

```
data ← Status
GPR[rt] ← data
StatusIE ← 0
```

Exceptions:

Coprocessor Unusable
Reserved Instruction (Release 1 implementations)

Programming Notes:

The effects of this instruction are identical to those accomplished by the sequence of reading *Status* into a GPR, clearing the IE bit, and writing the result back to *Status*. Unlike the multiple instruction sequence, however, the DI instruction cannot be aborted in the middle by an interrupt or exception.

This instruction creates an execution hazard between the change to the *Status* register and the point where the change to the interrupt enable takes effect. This hazard is cleared by the EHB, JALR.HB, JR.HB, or ERET instructions. Software must not assume that a fixed latency will clear the execution hazard.

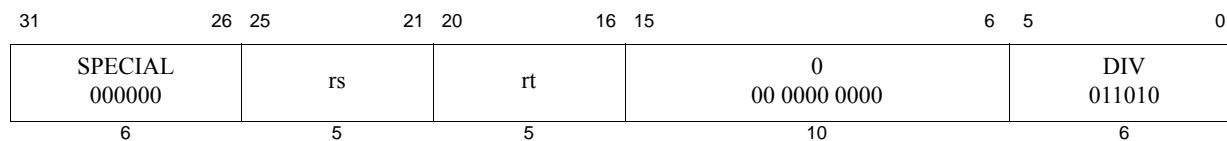

Format: DIV *rs*, *rt*

MIPS32, removed in Release 6

Purpose: Divide Word

To divide a 32-bit signed integers.

Description: (*HI*, *LO*) \leftarrow GPR[*rs*] / GPR[*rt*]

The 32-bit word value in GPR *rs* is divided by the 32-bit value in GPR *rt*, treating both operands as signed values. The 32-bit quotient is placed into special register *LO* and the 32-bit remainder is placed into special register *HI*.

No arithmetic exception occurs under any circumstances.

Restrictions:

If the divisor in GPR *rt* is zero, the arithmetic result value is **UNPREDICTABLE**.

Availability and Compatibility:

DIV has been removed in Release 6 and has been replaced by DIV and MOD instructions that produce only quotient and remainder, respectively. Refer to the Release 6 introduced ‘DIV’ and ‘MOD’ instructions in this manual for more information. This instruction remains current for all release levels lower than Release 6 of the MIPS architecture.

Operation:

$$\begin{aligned} q &\leftarrow \text{GPR}[rs]_{31..0} \text{ div } \text{GPR}[rt]_{31..0} \\ LO &\leftarrow q \\ r &\leftarrow \text{GPR}[rs]_{31..0} \text{ mod } \text{GPR}[rt]_{31..0} \\ HI &\leftarrow r \end{aligned}$$

Exceptions:

None

Programming Notes:

No arithmetic exception occurs under any circumstances. If divide-by-zero or overflow conditions are detected and some action taken, then the divide instruction is followed by additional instructions to check for a zero divisor and/or for overflow. If the divide is asynchronous then the zero-divisor check can execute in parallel with the divide. The action taken on either divide-by-zero or overflow is either a convention within the program itself, or within the system software. A possibility is to take a BREAK exception with a *code* field value to signal the problem to the system software.

As an example, the C programming language in a UNIX® environment expects division by zero to either terminate the program or execute a program-specified signal handler. C does not expect overflow to cause any exceptional condition. If the C compiler uses a divide instruction, it also emits code to test for a zero divisor and execute a BREAK instruction to inform the operating system if a zero is detected.

By default, most compilers for the MIPS architecture emits additional instructions to check for the divide-by-zero and overflow cases when this instruction is used. In many compilers, the assembler mnemonic “DIV r0, rs, rt” can be used to prevent these additional test instructions to be emitted.

In some processors the integer divide operation may proceed asynchronously and allow other CPU instructions to execute before it is complete. An attempt to read *LO* or *HI* before the results are written interlocks until the results are

ready. Asynchronous execution does not affect the program result, but offers an opportunity for performance improvement by scheduling the divide so that other instructions can execute in parallel.

Historical Perspective:

In MIPS 1 through MIPS III, if either of the two instructions preceding the divide is an MFHI or MFLO, the result of the MFHI or MFLO is **UNPREDICTABLE**. Reads of the *HI* or *LO* special register must be separated from subsequent instructions that write to them by two or more instructions. This restriction was removed in MIPS IV and MIPS32 and all subsequent levels of the architecture.

31	26 25	21 20	16 15	11 10	6 5	0
SPECIAL 000000	rs	rt	rd	DIV 00010	SOP32 011010	
SPECIAL 000000	rs	rt	rd	MOD 00011	SOP32 011010	
SPECIAL 000000	rs	rt	rd	DIVU 00010	SOP33 011011	
SPECIAL 000000	rs	rt	rd	MODU 00011	SOP33 011011	
6	5	5	5	5	6	

Format: DIV MOD DIVU MODU
 DIV rd,rs,rt
 MOD rd,rs,rt
 DIVU rd,rs,rt
 MODU rd,rs,rt

MIPS32 Release 6
 MIPS32 Release 6
 MIPS32 Release 6
 MIPS32 Release 6

Purpose: Divide Integers (with result to GPR)

DIV: Divide Words Signed
 MOD: Modulo Words Signed
 DIVU: Divide Words Unsigned
 MODU: Modulo Words Unsigned

Description:

DIV: GPR[rd] ← (divide.signed(GPR[rs], GPR[rt]))
 MOD: GPR[rd] ← (modulo.signed(GPR[rs], GPR[rt]))
 DIVU: GPR[rd] ← (divide.unsigned(GPR[rs], GPR[rt]))
 MODU: GPR[rd] ← (modulo.unsigned(GPR[rs], GPR[rt]))

The Release 6 divide and modulo instructions divide the operands in GPR rs and GPR rt, and place the quotient or remainder in GPR rd.

For each of the div/mod operator pairs DIV/M OD, DIVU/MODU, the results satisfy the equation $(A \text{ div } B) * B + (A \text{ mod } B) = A$, where $(A \text{ mod } B)$ has same sign as the dividend A, and $\text{abs}(A \text{ mod } B) < \text{abs}(B)$. This equation uniquely defines the results.

NOTE: if the divisor B=0, this equation cannot be satisfied, and the result is UNPREDICTABLE. This is commonly called “truncated division”.

DIV performs a signed 32-bit integer division, and places the 32-bit quotient result in the destination register.

MOD performs a signed 32-bit integer division, and places the 32-bit remainder result in the destination register. The remainder result has the same sign as the dividend.

DIVU performs an unsigned 32-bit integer division, and places the 32-bit quotient result in the destination register.

MODU performs an unsigned 32-bit integer division, and places the 32-bit remainder result in the destination register.

Restrictions:

If the divisor in GPR rt is zero, the result value is UNPREDICTABLE.

Availability and Compatibility:

These instructions are introduced by and required as of Release 6.

Release 6 divide instructions have the same opcode mnemonic as the pre-Release 6 divide instructions (DIV, DIVU). The instruction encodings are different, as are the instruction semantics: the Release 6 instruction produces only the quotient, whereas the pre-Release 6 instruction produces quotient and remainder in HI/LO registers respectively, and separate modulo instructions are required to obtain the remainder.

The assembly syntax distinguishes the Release 6 from the pre-Release 6 divide instructions. For example, Release 6 “DIV rd, rs, rt” specifies 3 register operands, versus pre-Release 6 “DIV rs, rt”, which has only two register arguments, with the HI/LO registers implied. Some assemblers accept the pseudo-instruction syntax “DIV rd, rs, rt” and expand it to do “DIV rs, rt; MFHI rd”. Phrases such as “DIV with GPR output” and “DIV with HI/LO output” may be used when disambiguation is necessary.

Pre-Release 6 divide instructions that produce quotient and remainder in the HI/LO registers produce a Reserved Instruction exception on Release 6. In the future, the instruction encoding may be reused for other instructions.

Programming Notes:

Because the divide and modulo instructions are defined to not trap if dividing by zero, it is safe to emit code that checks for zero-divide after the divide or modulo instruction.

Operation

```

DIV, MOD:
    s1 ← signed_word(GPR[rs])
    s2 ← signed_word(GPR[rt])
DIVU, MODU:
    s1 ← unsigned_word(GPR[rs])
    s2 ← unsigned_word(GPR[rt])

DIV, DIVU:
    quotient ← s1 div s2
MOD, MODU:
    remainder ← s1 mod s2

DIV:   GPR[rd] ← quotient
MOD:   GPR[rd] ← remainder
DIVU:  GPR[rd] ← quotient
MODU:  GPR[rd] ← remainder
/* end of instruction */
    
```

Exceptions:

No arithmetic exceptions occur. Division by zero produces an UNPREDICTABLE result.

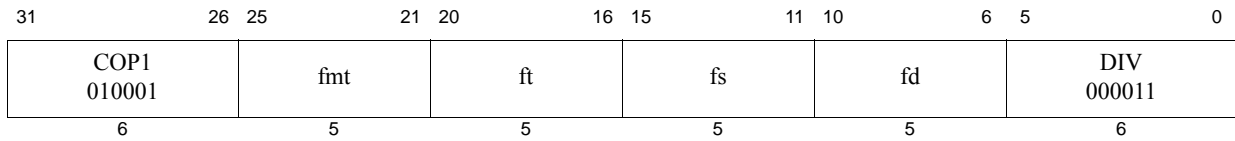

Format: DIV.fmt
 DIV.S *fd*, *fs*, *ft*
 DIV.D *fd*, *fs*, *ft*

MIPS32
MIPS32

Purpose: Floating Point Divide

To divide FP values.

Description: $FPR[fd] \leftarrow FPR[fs] / FPR[ft]$

The value in FPR *fs* is divided by the value in FPR *ft*. The result is calculated to infinite precision, rounded according to the current rounding mode in *FCSR*, and placed into FPR *fd*. The operands and result are values in format *fmt*.

Restrictions:

The fields *fs*, *ft*, and *fd* must specify FPRs valid for operands of type *fmt*. If the fields are not valid, the result is **UNPREDICABLE**.

The operands must be values in format *fmt*; if they are not, the result is **UNPREDICTABLE** and the value of the operand FPRs becomes **UNPREDICTABLE**.

Operation:

`StoreFPR (fd, fmt, ValueFPR(fs, fmt) / ValueFPR(ft, fmt))`

Exceptions:

Coprocessor Unusable, Reserved Instruction

Floating Point Exceptions:

Inexact, Invalid Operation, Unimplemented Operation, Division-by-zero, Overflow, Underflow

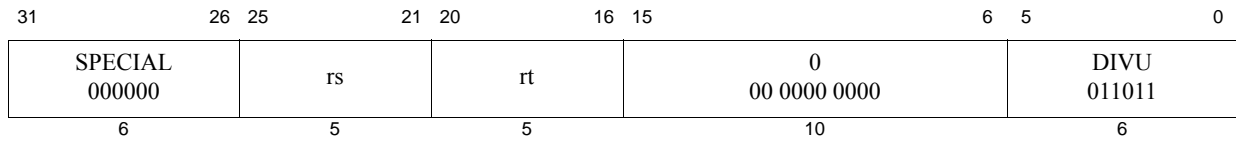

Format: DIVU *rs*, *rt*

MIPS32, removed in Release 6

Purpose: Divide Unsigned Word

To divide 32-bit unsigned integers

Description: (*HI*, *LO*) \leftarrow GPR[*rs*] / GPR[*rt*]

The 32-bit word value in GPR *rs* is divided by the 32-bit value in GPR *rt*, treating both operands as unsigned values. The 32-bit quotient is placed into special register *LO* and the 32-bit remainder is placed into special register *HI*.

No arithmetic exception occurs under any circumstances.

Restrictions:

If the divisor in GPR *rt* is zero, the arithmetic result value is **UNPREDICTABLE**.

Availability and Compatibility:

This instruction has been removed in Release 6.

Operation:

```

q ← (0 || GPR[rs]31..0) div (0 || GPR[rt]31..0)
r ← (0 || GPR[rs]31..0) mod (0 || GPR[rt]31..0)
LO ← sign_extend(q31..0)
HI ← sign_extend(r31..0)

```

Exceptions:

None

Programming Notes:

Pre-Release 6 instruction DIV has been removed in Release 6 and has been replaced by DIV and MOD instructions that produce only quotient and remainder, respectively. Refer to the Release 6 introduced ‘DIV’ and ‘MOD’ instructions in this manual for more information. This instruction remains current for all release levels lower than Release 6 of the MIPS architecture.

See “Programming Notes” for the [DIV](#) instruction.

Historical Perspective:

In MIPS 1 through MIPS III, if either of the two instructions preceding the divide is an MFHI or MFLO, the result of the MFHI or MFLO is UNPREDICTABLE. Reads of the *HI* or *LO* special register must be separated from subsequent instructions that write to them by two or more instructions. This restriction was removed in MIPS IV and MIPS32 and all subsequent levels of the architecture.

31	26 25	21 20	16 15	11 10	6 5	4 3	2	0
COP0 010000	MFMC0 01011	rt	0 00000	0 00000	sc 1	0 00	4 100	
6	5	5	5	5	1	2	3	

Format: DVP rt

MIPS32 Release 6

Purpose: Disable Virtual Processor

To disable all virtual processors in a physical core other than the virtual processor that issued the instruction.

Description: $GPR[rt] \leftarrow VPControl$; $VPControl_{DIS} \leftarrow 1$

Disabling a virtual processor means that instruction fetch is terminated, and all outstanding instructions for the affected virtual processor(s) must be complete before the DVP itself is allowed to retire. Any outstanding events such as hardware instruction or data prefetch, or page-table walks must also be terminated.

The DVP instruction has implicit SYNC(*stype*=0) semantics but with respect to the other virtual processors in the physical core.

After all other virtual processors have been disabled, $VPControl_{DIS}$ is set. Prior to modification and if *rt* is non-zero, $VPControl$ is written to $GPR[rt]$. If DVP is specified without *rt*, then *rt* must be 0.

DVP may also take effect on a virtual processor that has executed a WAIT or a PAUSE instruction. If a virtual processor has executed a WAIT instruction, then it cannot resume execution on an interrupt until an EVP has been executed. If the EVP is executed before the interrupt arrives, then the virtual processor resumes in a state as if the DVP had not been executed, that is, it waits for the interrupt.

If a virtual processor has executed a PAUSE instruction, then it cannot resume execution until an EVP has been executed, even if LLbit is cleared. If an EVP is executed before the LLbit is cleared, then the virtual processor resumes in a state as if the DVP has not been executed, that is, it waits for the LLbit to clear.

The execution of a DVP must be followed by the execution of an EVP. The execution of an EVP causes execution to resume immediately—where applicable—on all other virtual processors, as if the DVP had not been executed. The execution is completely restorable after the EVP. If an event occurs in between the DVP and EVP that renders state of the virtual processor UNPREDICTABLE (such as power-gating), then the effect of EVP is UNPREDICTABLE.

DVP may only take effect if $VPControl_{DIS}=0$. Otherwise it is treated as a NOP instruction.

If a virtual processor is disabled due to a DVP, then interrupts are also disabled for the virtual processor, that is, logically $Status_{IE}=0$. $Status_{IE}$ for the target virtual processors though is not cleared though as software cannot access state on the virtual processors that have been disabled. Similarly, deferred exceptions will not cause a disabled virtual processor to be re-enabled for execution, at least until execution is re-enabled by the EVP instruction. The virtual processor that executes the DVP, however, continues to be interruptible.

In an implementation, the ability of a virtual processor to execute instructions may also be under control external to the physical core which contains the virtual processor. If disabled by DVP, a virtual processor must not resume fetch in response to the assertion of this external signal to enable fetch. Conversely, if fetch is disabled by such external control, then execution of EVP will not cause fetch to resume at a target virtual processor for which the control is deasserted.

This instruction never executes speculatively. It must be the oldest unretired instruction to take effect.

This instruction is only available in Release 6 implementations. For implementations that do not support multi-threading ($Config5_{VP}=0$), this instruction must be treated as a NOP instruction.

Restrictions:

If access to Coprocessor 0 is not enabled, a Coprocessor Unusable Exception is signaled.

In implementations prior to Release 6 of the architecture, this instruction resulted in a Reserved Instruction exception.

Operation:

The pseudo-code below assumes that the DVP is executed by virtual processor 0, while the target virtual processor is numbered ‘n’, where n is each of all remaining virtual processors.

```

if (VPControlDIS = 0)

    // Pseudo-code in italics provides recommended action wrt other VPs
    disable_fetch(VPn) {
        if PAUSE(VPn) retires prior or at disable event
            then VPn execution is not resumed if LLbit is cleared prior to EVP
    }
    disable_interrupt(VPn) {
        if WAIT(VPn) retires prior or at disable event
            then interrupts are ignored by VPn until EVP
    }
    // DVP0 not retired until instructions for VPn completed
    while (VPn outstanding instruction)
        DVP0 unretired
    endwhile

endif

data ← VPControl
GPR[rt] ← data
VPControlDIS ← 1

```

Exceptions:

Coprocessor Unusable
Reserved Instruction (pre-Release 6 implementations)

Programming Notes:

DVP may disable execution in the target virtual processor regardless of the operating mode - kernel, supervisor, user. Kernel software may also be in a critical region, or in a high-priority interrupt handler when the disable occurs. Since the instruction is itself privileged, such events are considered acceptable.

Before executing an EVP in a DVP/EVP pair, software should first read VPControl_{DIS}, returned by DVP, to determine whether the virtual processors are already disabled. If so, the DVP/EVP sequence should be abandoned. This step allows software to safely nest DVP/EVP pairs.

Privileged software may use DVP/EVP to disable virtual processors on a core, such as for the purpose of doing a cache flush without interference from other processes in a system with multiple virtual processors or physical cores.

DVP (and EVP) may be used in other cases such as for power-savings or changing state that is applicable to all virtual processors in a core, such as virtual processor scheduling priority, as described below :

```

ll t0 0(a0)
dvp    // disable all other virtual processors
pause  // wait for LLbit to clear
evp    // enable all othe virtual processors

```

```
ll t0 0(a0)
dvp    // disable all other virtual processors
<change core-wide state>
evp    // enable all other virtual processors
```

31	26 25	21 20	16 15	11 10	6 5	0
SPECIAL 000000	0 00000	0 00000	0 00000	3 00011	SLL 000000	
6	5	5	5	5	6	

Format: EHB

Assembly Idiom MIPS32 Release 2

Purpose: Execution Hazard Barrier

To stop instruction execution until all execution hazards have been cleared.

Description:

EHB is used to denote execution hazard barrier. The actual instruction is interpreted by the hardware as SLL r0, r0, 3. This instruction alters the instruction issue behavior on a pipelined processor by stopping execution until all execution hazards have been cleared. Other than those that might be created as a consequence of setting *Status_{CU0}*, there are no execution hazards visible to an unprivileged program running in User Mode. All execution hazards created by previous instructions are cleared for instructions executed immediately following the EHB, even if the EHB is executed in the delay slot of a branch or jump. The EHB instruction does not clear instruction hazards—such hazards are cleared by the JALR.HB, JR.HB, and ERET instructions.

Restrictions:

None

Operation:

```
ClearExecutionHazards()
```

Exceptions:

None

Programming Notes:

In Release 2 implementations, this instruction resolves all execution hazards. On a superscalar processor, EHB alters the instruction issue behavior in a manner identical to SSNOP. For backward compatibility with Release 1 implementations, the last of a sequence of SSNOPs can be replaced by an EHB. In Release 1 implementations, the EHB will be treated as an SSNOP, thereby preserving the semantics of the sequence. In Release 2 implementations, replacing the final SSNOP with an EHB should have no performance effect because a properly sized sequence of SSNOPs will have already cleared the hazard. As EHB becomes the standard in MIPS implementations, the previous SSNOPs can be removed, leaving only the EHB.

31	26 25	21 20	16 15	11 10	6 5	4 3	2	0
COP0 0100 00	MFMC0 01 011	rt	12 0110 0	0 000 00	sc 1	0 0 0	0 000	0
6	5	5	5	5	1	2	3	

Format: EI
EI rt

MIPS32 Release 2
MIPS32 Release 2

Purpose: Enable Interrupts

To return the previous value of the *Status* register and enable interrupts. If EI is specified without an argument, GPR r0 is implied, which discards the previous value of the *Status* register.

Description: $GPR[rt] \leftarrow Status; Status_{IE} \leftarrow 1$

The current value of the *Status* register is loaded into general register *rt*. The Interrupt Enable (*IE*) bit in the *Status* register is then set.

Restrictions:

If access to Coprocessor 0 is not enabled, a Coprocessor Unusable Exception is signaled.

In implementations prior to Release 2 of the architecture, this instruction resulted in a Reserved Instruction exception.

Operation:

This operation specification is for the general interrupt enable/disable operation, with the *sc* field as a variable. The individual instructions DI and EI have a specific value for the *sc* field.

```
data ← Status
GPR[rt] ← data
StatusIE ← 1
```

Exceptions:

Coprocessor Unusable
Reserved Instruction (Release 1 implementations)

Programming Notes:

The effects of this instruction are identical to those accomplished by the sequence of reading *Status* into a GPR, setting the *IE* bit, and writing the result back to *Status*. Unlike the multiple instruction sequence, however, the EI instruction cannot be aborted in the middle by an interrupt or exception.

This instruction creates an execution hazard between the change to the *Status* register and the point where the change to the interrupt enable takes effect. This hazard is cleared by the EHB, JALR.HB, JR.HB, or ERET instructions. Software must not assume that a fixed latency will clear the execution hazard.

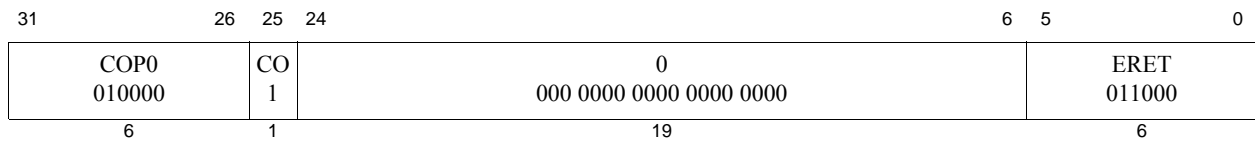

Format: ERET

MIPS32

Purpose: Exception Return

To return from interrupt, exception, or error trap.

Description:

ERET clears execution and instruction hazards, conditionally restores $SRSCtl_{CSS}$ from $SRSCtl_{PSS}$ in a Release 2 implementation, and returns to the interrupted instruction at the completion of interrupt, exception, or error processing. ERET does not execute the next instruction (that is, it has no delay slot).

Restrictions:

Pre-Release 6: The operation of the processor is **UNDEFINED** if an ERET is executed in the delay slot of a branch or jump instruction.

Release 6: Implementations are required to signal a Reserved Instruction exception if ERET is encountered in the delay slot or forbidden slot of a branch or jump instruction.

An ERET placed between an LL and SC instruction will always cause the SC to fail.

ERET implements a software barrier that resolves all execution and instruction hazards created by Coprocessor 0 state changes (for Release 2 implementations, refer to the SYNCI instruction for additional information on resolving instruction hazards created by writing the instruction stream). The effects of this barrier are seen starting with the instruction fetch and decode of the instruction at the PC to which the ERET returns.

In a Release 2 implementation, ERET does not restore $SRSCtl_{CSS}$ from $SRSCtl_{PSS}$ if $Status_{BEV} = 1$, or if $Status_{ERL} = 1$ because any exception that sets $Status_{ERL}$ to 1 (Reset, Soft Reset, NMI, or cache error) does not save $SRSCtl_{CSS}$ in $SRSCtl_{PSS}$. If software sets $Status_{ERL}$ to 1, it must be aware of the operation of an ERET that may be subsequently executed.

Operation:

```

if StatusERL = 1 then
    temp ← ErrorEPC
    StatusERL ← 0
else
    temp ← EPC
    StatusEXL ← 0
    if (ArchitectureRevision ≥ 2) and (SRSCtlHSS > 0) and (StatusBEV = 0) then
        SRSCtlCSS ← SRSCtlPSS
    endif
endif
if IsMIPS16Implemented() | (Config3ISA > 0) then
    PC ← temp31..1 || 0
    ISAMode ← temp0
else
    PC ← temp
endif
LLbit ← 0
ClearHazards()

```

Exceptions:

Coprocessor Unusable Exception

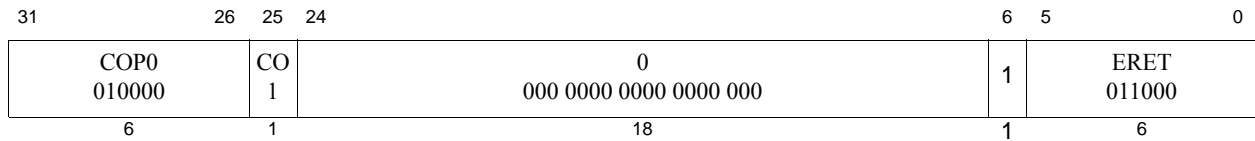

Format: ERETNC

MIPS32 Release 5

Purpose: Exception Return No Clear

To return from interrupt, exception, or error trap without clearing the LLbit.

Description:

ERETNC clears execution and instruction hazards, conditionally restores $SRSCtl_{CSS}$ from $SRSCtl_{PSS}$ when implemented, and returns to the interrupted instruction at the completion of interrupt, exception, or error processing. ERETNC does not execute the next instruction (i.e., it has no delay slot).

ERETNC is identical to ERET except that an ERETNC will not clear the LLbit that is set by execution of an LL instruction, and thus when placed between an LL and SC sequence, will never cause the SC to fail.

An ERET must continue to be used by default in interrupt and exception processing handlers. The handler may have accessed a synchronizable block of memory common to code that is atomically accessing the memory, and where the code caused the exception or was interrupted. Similarly, a process context-swap must also continue to use an ERET in order to avoid a possible false success on execution of SC in the restored context.

Multiprocessor systems with non-coherent cores (i.e., without hardware coherence snooping) should also continue to use ERET, because it is the responsibility of software to maintain data coherence in the system.

An ERETNC is useful in cases where interrupt/exception handlers and kernel code involved in a process context-swap can guarantee no interference in accessing synchronizable memory across different contexts. ERETNC can also be used in an OS-level debugger to single-step through code for debug purposes, avoiding the false clearing of the LLbit and thus failure of an LL and SC sequence in single-stepped code.

Software can detect the presence of ERETNC by reading $Config5_{LLB}$.

Restrictions:

Release 6 implementations are required to signal a Reserved Instruction exception if ERETNC is executed in the delay slot or Release 6 forbidden slot of a branch or jump instruction.

ERETNC implements a software barrier that resolves all execution and instruction hazards created by Coprocessor 0 state changes. (For Release 2 implementations, refer to the SYNCI instruction for additional information on resolving instruction hazards created by writing the instruction stream.) The effects of this barrier are seen starting with the instruction fetch and decode of the instruction in the PC to which the ERETNC returns.

Operation:

```

if StatusERL = 1 then
    temp ← ErrorEPC
    StatusERL ← 0
else
    temp ← EPC
    StatusEXL ← 0
    if (ArchitectureRevision ≥ 2) and (SRSCtlHSS > 0) and (StatusBEV = 0) then
        SRSCtlCSS ← SRSCtlPSS
    endif
endif
if IsMIPS16Implemented() | (Config3ISA > 0) then

```

```
PC ← temp31..1 || 0
ISAMode ← temp0
else
  PC ← temp
endif
ClearHazards()
```

Exceptions:

Coprocessor Unusable Exception

31	26 25	21 20	16 15	11 10	6 5	4 3	2	0
COP0 010000	MFMC0 01011	rt	0 00000	0 00000	sc 0	0 00	4 100	
6	5	5	5	5	1	2	3	

Format: EVP rt

MIPS32 Release 6

Purpose: Enable Virtual Processor

To enable all virtual processors in a physical core other than the virtual processor that issued the instruction.

Description: $GPR[rt] \leftarrow VPControl$; $VPControl_{DIS} \leftarrow 0$

Enabling a virtual processor means that instruction fetch is resumed.

After all other virtual processors have been enabled, $VPControl_{DIS}$ is cleared. Prior to modification, if rt is non-zero, $VPControl$ is written to $GPR[rt]$. If EVP is specified without rt , then rt must be 0.

See the DVP instruction to understand the application of EVP in the context of WAIT/PAUSE/external-control (“DVP” on page 162).

The execution of a DVP must be followed by the execution of an EVP. The execution of an EVP causes execution to resume immediately, *where applicable*, on all other virtual processors, as if the DVP had not been executed, that is, execution is completely restorable after the EVP. On the other hand, if an event occurs in between the DVP and EVP that renders state of the virtual processor UNPREDICTABLE (such as power-gating), then the effect of EVP is UNPREDICTABLE.

EVP may only take effect if $VPControl_{DIS}=1$. Otherwise it is treated as a NOP

This instruction never executes speculatively. It must be the oldest unretired instruction to take effect.

This instruction is only available in Release 6 implementations. For implementations that do not support multi-threading ($Config5_{VP}=0$), this instruction must be treated as a NOP instruction.

Restrictions:

If access to Coprocessor 0 is not enabled, a Coprocessor Unusable Exception is signaled.

In implementations prior to Release 6 of the architecture, this instruction resulted in a Reserved Instruction exception.

Operation:

The pseudo-code below assumes that the EVP is executed by virtual processor 0, while the target virtual processor is numbered ‘n’, where n is each of all remaining virtual processors.

```

if (VPControlDIS = 1)

    // Pseudo-code in italics provides recommended action wrt other VPs
    enable_fetch(VPn) {
        if PAUSE(VPn) retires prior or at disable event
            then VPn execution is not resumed if LLbit is cleared prior to EVP
    }
    enable_interrupt(VPn) {
        if WAIT(VPn) retires prior or at disable event
            then interrupts are ignored by VPn until EVP
    }

```

```

        endif

    data ← VPControl
    GPR[rt] ← data
    VPControlDIS ← 0

```

Exceptions:

Coprocessor Unusable
Reserved Instruction (pre-Release 6 implementations)

Programming Notes:

Before executing an EVP in a DVP/EVP pair, software should first read `VPControlDIS`, returned by DVP, to determine whether the virtual processors are already disabled. If so, the DVP/EVP sequence should be abandoned. This step allows software to safely nest DVP/EVP pairs.

Privileged software may use DVP/EVP to disable virtual processors on a core, such as for the purpose of doing a cache flush without interference from other processes in a system with multiple virtual processors or physical cores.

DVP (and EVP) may be used in other cases such as for power-savings or changing state that is applicable to all virtual processors in a core, such as virtual processor scheduling priority, as described below:

```

ll t0 0(a0)
dvp    // disable all other virtual processors
pause  // wait for LLbit to clear
evp    // enable all othe virtual processors

ll t0 0(a0)
dvp    // disable all other virtual processors
<change core-wide state>
evp    // enable all othe virtual processors

```

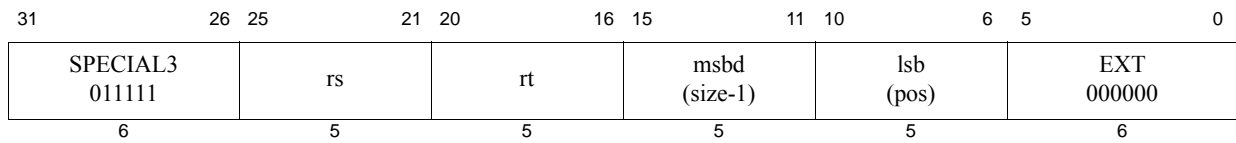

Format: EXT *rt*, *rs*, *pos*, *size*

MIPS32 Release 2

Purpose: Extract Bit Field

To extract a bit field from GPR *rs* and store it right-justified into GPR *rt*.

Description: $GPR[rt] \leftarrow \text{ExtractField}(GPR[rs], \text{msbd}, \text{lsb})$

The bit field starting at bit *pos* and extending for *size* bits is extracted from GPR *rs* and stored zero-extended and right-justified in GPR *rt*. The assembly language arguments *pos* and *size* are converted by the assembler to the instruction fields *msbd* (the most significant bit of the destination field in GPR *rt*), in instruction bits **15..11**, and *lsb* (least significant bit of the source field in GPR *rs*), in instruction bits **10..6**, as follows:

```
msbd ← size-1
lsb ← pos
```

The values of *pos* and *size* must satisfy all of the following relations:

```
0 ≤ pos < 32
0 < size ≤ 32
0 < pos+size ≤ 32
```

Figure 3-9 shows the symbolic operation of the instruction.

Figure 3.5 Operation of the EXT Instruction

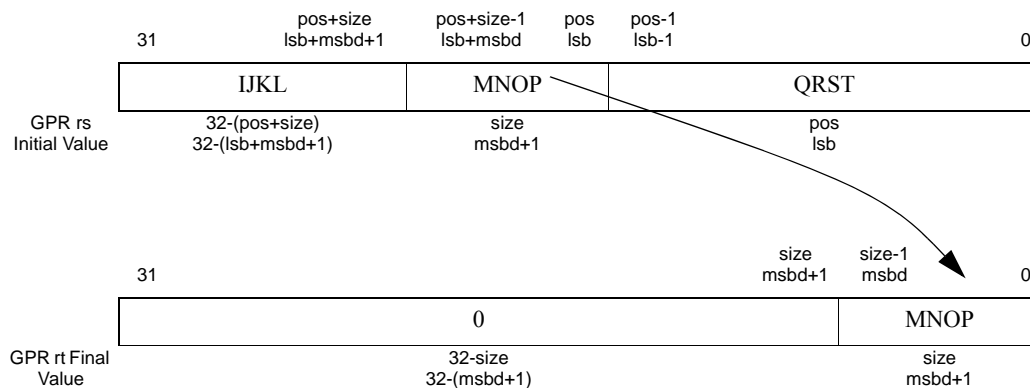

Restrictions:

In implementations prior to Release 2 of the architecture, this instruction resulted in a Reserved Instruction exception. The operation is **UNPREDICTABLE** if $lsb+msbd > 31$.

Operation:

```
if (lsb + msbd) > 31) then
    UNPREDICTABLE
endif
temp ← 032-(msbd+1) || GPR[rs]msbd+lsb..lsb
GPR[rt] ← temp
```

Exceptions:

Reserved Instruction

31	26 25	21 20	16 15	11 10	6 5	0
COP1 010001	fmt	0 00000	fs	fd	FLOOR.L 001011	
6	5	5	5	5	6	

Format: FLOOR.L.fmt
 FLOOR.L.S fd, fs
 FLOOR.L.D fd, fs

MIPS32 Release 2
MIPS32 Release 2

Purpose: Floating Point Floor Convert to Long Fixed Point

To convert an FP value to 64-bit fixed point, rounding down

Description: $FPR[fd] \leftarrow \text{convert_and_round}(FPR[fs])$

The value in FPR *fs*, in format *fmt*, is converted to a value in 64-bit long fixed point format and rounded toward \geq (rounding mode 3). The result is placed in FPR *fd*.

When the source value is Infinity, NaN, or rounds to an integer outside the range -2^{63} to $2^{63}-1$, the result cannot be represented correctly, an IEEE Invalid Operation condition exists, and the Invalid Operation flag is set in the *FCSR*. If the Invalid Operation Enable bit is set in the *FCSR*, no result is written to *fd* and an Invalid Operation exception is taken immediately. Otherwise, a default result is written to *fd*. On cores with $FCSR_{NAN2008}=0$, the default result is $2^{63}-1$. On cores with $FCSR_{NAN2008}=1$, the default result is:

- 0 when the input value is NaN
- $2^{63}-1$ when the input value is $+\infty$ or rounds to a number larger than $2^{63}-1$
- $-2^{63}-1$ when the input value is $-\infty$ or rounds to a number smaller than $-2^{63}-1$

Restrictions:

The fields *fs* and *fd* must specify valid FPRs: *fs* for type *fmt* and *fd* for long fixed point. If the fields are not valid, the result is **UNPREDICTABLE**.

The operand must be a value in format *fmt*; if it is not, the result is **UNPREDICTABLE** and the value of the operand FPR becomes **UNPREDICTABLE**.

The result of this instruction is **UNPREDICTABLE** if the processor is executing in the $FR=0$ 32-bit FPU register model; it is predictable if executing on a 64-bit FPU in the $FR=1$ mode, but not with $FR=0$, and not on a 32-bit FPU.

Operation:

$\text{StoreFPR}(fd, L, \text{ConvertFmt}(\text{ValueFPR}(fs, fmt), fmt, L))$

Exceptions:

Coprocessor Unusable, Reserved Instruction

Floating Point Exceptions:

Invalid Operation, Unimplemented Operation, Inexact

31	26 25	21 20	16 15	11 10	6 5	0
COP1 010001	fmt	0 00000	fs	fd	FLOOR.W 001111	
6	5	5	5	5	6	

Format: FLOOR.W.fmt

FLOOR.W.S fd, fs

FLOOR.W.D fd, fs

MIPS32

MIPS32

Purpose: Floating Point Floor Convert to Word Fixed Point

To convert an FP value to 32-bit fixed point, rounding down

Description: $FPR[fd] \leftarrow \text{convert_and_round}(FPR[fs])$

The value in FPR *fs*, in format *fmt*, is converted to a value in 32-bit word fixed point format and rounded toward \rightarrow (rounding mode 3). The result is placed in FPR *fd*.

When the source value is Infinity, NaN, or rounds to an integer outside the range -2^{31} to $2^{31}-1$, the result cannot be represented correctly, an IEEE Invalid Operation condition exists, and the Invalid Operation flag is set in the *FCSR*. If the Invalid Operation *Enable* bit is set in the *FCSR*, no result is written to *fd* and an Invalid Operation exception is taken immediately. Otherwise, a default result is written to *fd*. On cores with $FCSR_{NAN2008}=0$, the default result is $2^{31}-1$. On cores with $FCSR_{NAN2008}=1$, the default result is:

- 0 when the input value is NaN
- $2^{31}-1$ when the input value is $+\infty$ or rounds to a number larger than $2^{31}-1$
- $-2^{31}-1$ when the input value is $-\infty$ or rounds to a number smaller than $-2^{31}-1$

Restrictions:

The fields *fs* and *fd* must specify valid FPRs: *fs* for type *fmt* and *fd* for word fixed point. If the fields are not valid, the result is **UNPREDICTABLE**.

The operand must be a value in format *fmt*; if it is not, the result is **UNPREDICTABLE** and the value of the operand FPR becomes **UNPREDICTABLE**.

Operation:

$\text{StoreFPR}(fd, W, \text{ConvertFmt}(\text{ValueFPR}(fs, fmt), fmt, W))$

Exceptions:

Coprocessor Unusable, Reserved Instruction

Floating Point Exceptions:

Invalid Operation, Unimplemented Operation, Inexact

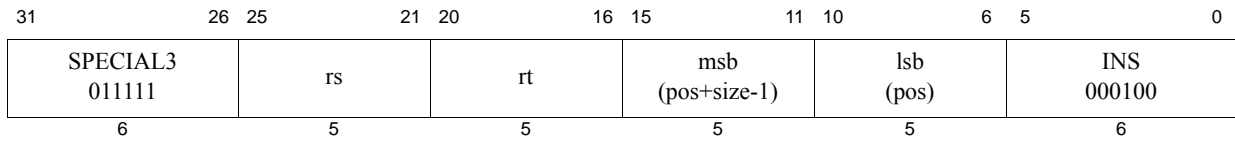

Format: INS *rt*, *rs*, *pos*, *size*

MIPS32 Release 2

Purpose: Insert Bit Field

To merge a right-justified bit field from GPR *rs* into a specified field in GPR *rt*.

Description: $GPR[rt] \leftarrow \text{InsertField}(GPR[rt], GPR[rs], msb, lsb)$

The right-most *size* bits from GPR *rs* are merged into the value from GPR *rt* starting at bit position *pos*. The result is placed back in GPR *rt*. The assembly language arguments *pos* and *size* are converted by the assembler to the instruction fields *msb* (the most significant bit of the field), in instruction bits 15..11, and *lsb* (least significant bit of the field), in instruction bits 10..6, as follows:

```
msb ← pos+size-1
lsb ← pos
```

The values of *pos* and *size* must satisfy all of the following relations:

```
0 ≤ pos < 32
0 < size ≤ 32
0 < pos+size ≤ 32
```

Figure 3-10 shows the symbolic operation of the instruction.

Figure 3.6 Operation of the INS Instruction

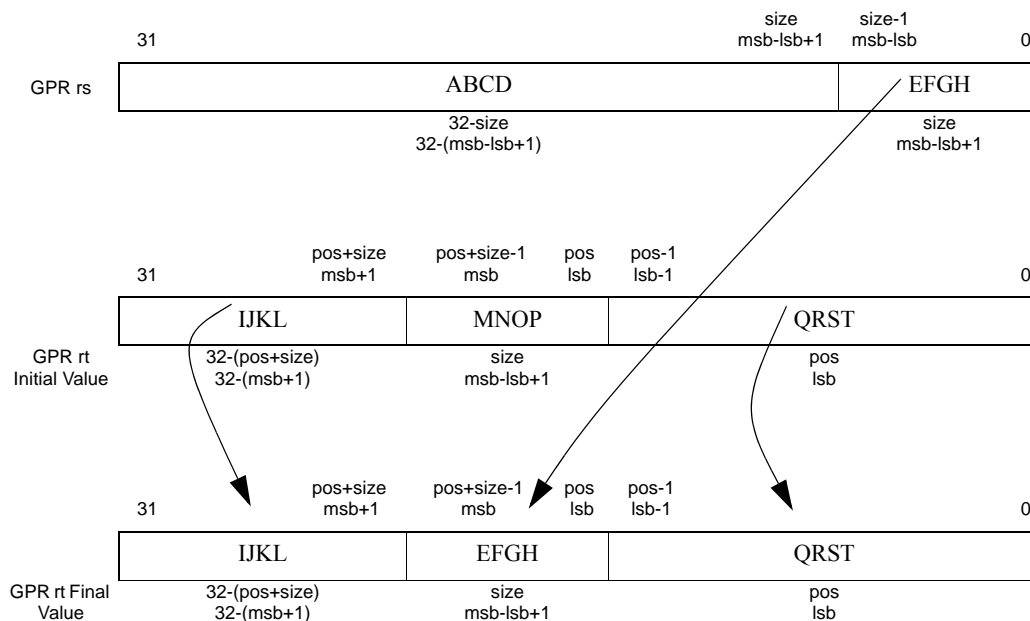

Restrictions:

In implementations prior to Release 2 of the architecture, this instruction resulted in a Reserved Instruction exception.

The operation is **UNPREDICTABLE** if $lsb > msb$.

Operation:

```
if lsb > msb) then
    UNPREDICTABLE
endif
GPR[rt] ← GPR[rt]31..msb+1 || GPR[rs]msb-1sb..0 || GPR[rt]1sb-1..0
```

Exceptions:

Reserved Instruction

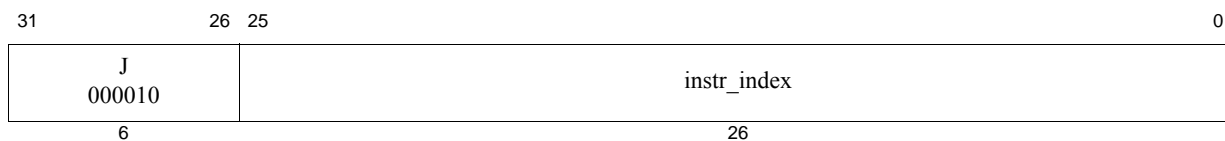

Format: J target

MIPS32

Purpose: Jump

To branch within the current 256 MB-aligned region.

Description:

This is a PC-region branch (not PC-relative); the effective target address is in the “current” 256 MB-aligned region. The low 28 bits of the target address is the *instr_index* field shifted left 2bits. The remaining upper bits are the corresponding bits of the address of the instruction in the delay slot (not the branch itself).

Jump to the effective target address. Execute the instruction that follows the jump, in the branch delay slot, before executing the jump itself.

Restrictions:

Control Transfer Instructions (CTIs) should not be placed in branch delay slots or Release 6 forbidden slots. CTIs include all branches and jumps, NAL, ERET, ERETNC, DERET, WAIT, and PAUSE.

Pre-Release 6: Processor operation is **UNPREDICTABLE** if a control transfer instruction (CTI) is placed in the delay slot of a branch or jump.

Release 6: If a control transfer instruction (CTI) is executed in the delay slot of a branch or jump, Release 6 implementations are required to signal a Reserved Instruction exception.

Operation:

I:
I+1: $PC \leftarrow PC_{GPRLEN-1..28} \parallel instr_index \parallel 0^2$

Exceptions:

None

Programming Notes:

Forming the branch target address by catenating PC and index bits rather than adding a signed offset to the PC is an advantage if all program code addresses fit into a 256MB region aligned on a 256MB boundary. It allows a branch from anywhere in the region to anywhere in the region, an action not allowed by a signed relative offset.

This definition creates the following boundary case: When the jump instruction is in the last word of a 256MB region, it can branch only to the following 256MB region containing the branch delay slot.

The Jump instruction has been deprecated in Release 6. Use BC instead.

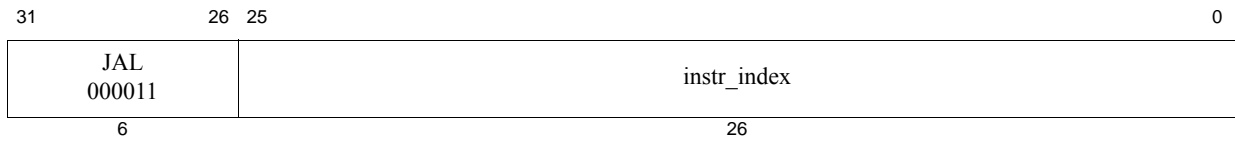

Format: JAL target

MIPS32

Purpose: Jump and Link

To execute a procedure call within the current 256MB-aligned region.

Description:

Place the return address link in GPR 31. The return link is the address of the second instruction following the branch, at which location execution continues after a procedure call.

This is a PC-region branch (not PC-relative); the effective target address is in the “current” 256MB-aligned region. The low 28 bits of the target address is the *instr_index* field shifted left 2bits. The remaining upper bits are the corresponding bits of the address of the instruction in the delay slot (not the branch itself).

Jump to the effective target address. Execute the instruction that follows the jump, in the branch delay slot, before executing the jump itself.

Restrictions:

Control Transfer Instructions (CTIs) should not be placed in branch delay slots or Release 6 forbidden slots. CTIs include all branches and jumps, NAL, ERET, ERETNC, DERET, WAIT, and PAUSE.

Pre-Release 6: Processor operation is **UNPREDICTABLE** if a control transfer instruction (CTI) is placed in the delay slot of a branch or jump.

Release 6: If a control transfer instruction (CTI) is executed in the delay slot of a branch or jump, Release 6 implementations are required to signal a Reserved Instruction exception.

Operation:

I: GPR[31] ← PC + 8
I+1: PC ← PC_{GPRLEN-1..28} || instr_index || 0²

Exceptions:

None

Programming Notes:

Forming the branch target address by concatenating PC and index bits rather than adding a signed offset to the PC is an advantage if all program code addresses fit into a 256MB region aligned on a 256MB boundary. It allows a branch from anywhere in the region to anywhere in the region, an action not allowed by a signed relative offset.

This definition creates the following boundary case: When the branch instruction is in the last word of a 256MB region, it can branch only to the following 256MB region containing the branch delay slot.

The Jump-and-Link instruction has been deprecated in Release 6. Use BALC instead.

pre-Release 6

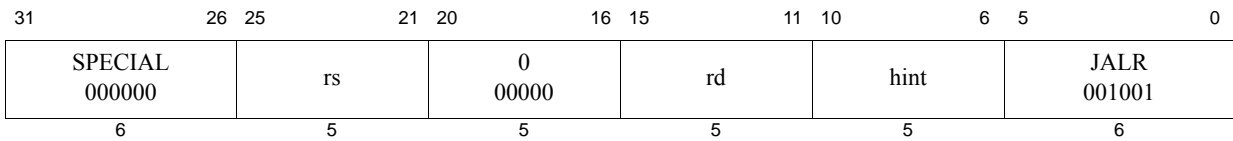

Release 6

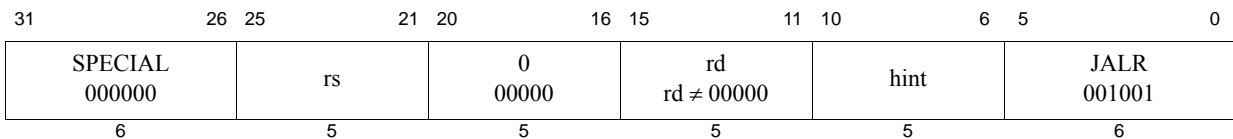

Format: JALR rs (rd = 31 implied)
JALR rd, rs

MIPS32
MIPS32

Purpose: Jump and Link Register

To execute a procedure call to an instruction address in a register

Description: $GPR[rd] \leftarrow return_addr, PC \leftarrow GPR[rs]$

Place the return address link in GPR *rd*. The return link is the address of the second instruction following the branch, where execution continues after a procedure call.

For processors that do not implement the MIPS16e or microMIPS ISA:

- Jump to the effective target address in GPR *rs*. If the target address is not 4-byte aligned, an Address Error exception will occur when the target address is fetched.

For processors that do implement the MIPS16e or microMIPS ISA:

- Jump to the effective target address in GPR *rs*. Set the ISA Mode bit to the value in GPR *rs* bit 0. Set bit 0 of the target address to zero. If the target ISA Mode bit is 0 and the target address is not 4-byte aligned, an Address Error exception will occur when the target instruction is fetched.

In both cases, execute the instruction that follows the jump, in the branch delay slot, before executing the jump itself.

In Release 1 of the architecture, the only defined hint field value is 0, which sets default handling of JALR. In Release 2 of the architecture, bit 10 of the hint field is used to encode a hazard barrier. See the [JALR.HB](#) instruction description for additional information.

Restrictions:

Control Transfer Instructions (CTIs) should not be placed in branch delay slots or Release 6 forbidden slots. CTIs include all branches and jumps, NAL, ERET, ERETNC, DERET, WAIT, and PAUSE.

Pre-Release 6: Processor operation is **UNPREDICTABLE** if a control transfer instruction (CTI) is placed in the delay slot of a branch or jump.

Release 6: If a control transfer instruction (CTI) is executed in the delay slot of a branch or jump, Release 6 implementations are required to signal a Reserved Instruction exception.

Jump-and-Link Restartability: Register specifiers *rs* and *rd* must not be equal, because such an instruction does not have the same effect when re-executed. The result of executing such an instruction is **UNPREDICTABLE**. This restriction permits an exception handler to resume execution by re-executing the branch when an exception occurs in the delay slot.

Restrictions Related to Multiple Instruction Sets: This instruction can change the active instruction set, if more than one instruction set is implemented.

If only one instruction set is implemented, then the effective target address must obey the alignment rules of the instruction set. If multiple instruction sets are implemented, the effective target address must obey the alignment rules of the intended instruction set of the target address as specified by the bit 0 or GPR *rs*.

For processors that do not implement the microMIPS32/64 ISA, the effective target address in GPR *rs* must be naturally-aligned. For processors that do not implement the MIPS16e ASE nor microMIPS32/64 ISA, if either of the two least-significant bits are not zero, an Address Error exception occurs when the branch target is subsequently fetched as an instruction.

For processors that do implement the MIPS16e ASE or microMIPS32/64 ISA, if target ISAMode bit is zero (GPR *rs* bit 0) and bit 1 is one, an Address Error exception occurs when the jump target is subsequently fetched as an instruction.

Availability and Compatibility:

Release 6 maps JR and JR.HB to JALR and JALR.HB with *rd* = 0:

Pre-Release 6, JR and JALR were distinct instructions, both with primary opcode SPECIAL, but with distinct function codes.

Release 6: JR is defined to be JALR with the destination register specifier *rd* set to 0. The primary opcode and function field are the same for JR and JALR. The pre-Release 6 instruction encoding for JR is removed in Release 6.

Release 6 assemblers should accept the JR and JR.HB mnemonics, mapping them to the Release 6 instruction encodings.

Operation:

```

I: temp ← GPR[rs]
   GPR[rd] ← PC + 8
I+1: if (Config3ISA = 0) and (Config1CA = 0) then
      PC ← temp
   else
      PC ← tempGPREN-1..1 || 0
      ISAMode ← temp0
   endif

```

Exceptions:

None

Programming Notes:

This jump-and-link register instruction can select a register for the return link; other link instructions use GPR 31. The default register for GPR *rd*, if omitted in the assembly language instruction, is GPR 31.

pre-Release 6:

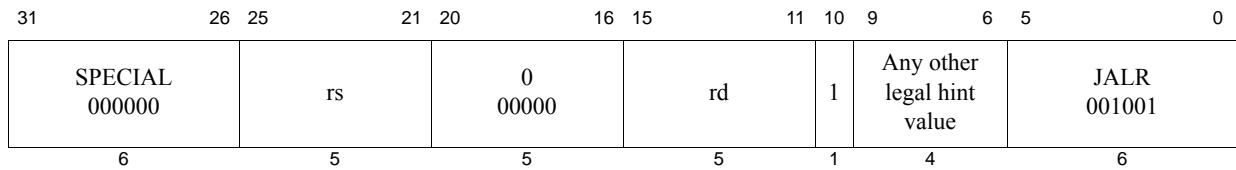

Release 6:

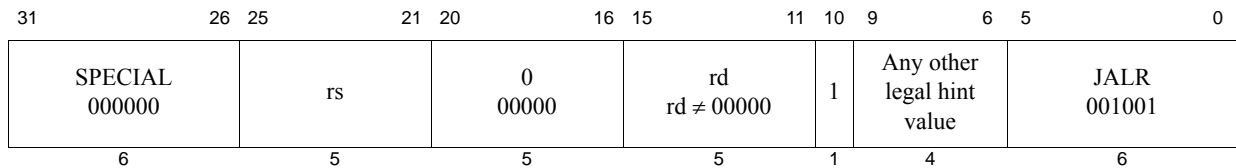

Format: JALR.HB rs (rd = 31 implied)
JALR.HB rd, rs

MIPS32 Release 2
MIPS32 Release 2

Purpose: Jump and Link Register with Hazard Barrier

To execute a procedure call to an instruction address in a register and clear all execution and instruction hazards

Description: $GPR[rd] \leftarrow return_addr$, $PC \leftarrow GPR[rs]$, clear execution and instruction hazards

Place the return address link in GPR *rd*. The return link is the address of the second instruction following the branch, where execution continues after a procedure call.

For processors that do not implement the MIPS16e or microMIPS ISA:

- Jump to the effective target address in GPR *rs*. If the target address is not 4-byte aligned, an Address Error exception will occur when the target address is fetched.

For processors that do implement the MIPS16e or microMIPS ISA:

- Jump to the effective target address in GPR *rs*. Set the ISA Mode bit to the value in GPR *rs* bit 0. Set bit 0 of the target address to zero. If the target ISA Mode bit is 0 and the target address is not 4-byte aligned, an Address Error exception will occur when the target instruction is fetched.

In both cases, execute the instruction that follows the jump, in the branch delay slot, before executing the jump itself.

JALR.HB implements a software barrier that resolves all execution and instruction hazards created by Coprocessor 0 state changes (for Release 2 implementations, refer to the SYNCI instruction for additional information on resolving instruction hazards created by writing the instruction stream). The effects of this barrier are seen starting with the instruction fetch and decode of the instruction at the PC to which the JALR.HB instruction jumps. An equivalent barrier is also implemented by the ERET instruction, but that instruction is only available if access to Coprocessor 0 is enabled, whereas JALR.HB is legal in all operating modes.

This instruction clears both execution and instruction hazards. Refer to the [EHB](#) instruction description for the method of clearing execution hazards alone.

JALR.HB uses bit 10 of the instruction (the upper bit of the hint field) to denote the hazard barrier operation.

Restrictions:

JALR.HB does not clear hazards created by any instruction that is executed in the delay slot of the JALR.HB. Only hazards created by instructions executed before the JALR.HB are cleared by the JALR.HB.

After modifying an instruction stream mapping or writing to the instruction stream, execution of those instructions has **UNPREDICTABLE** behavior until the instruction hazard has been cleared with JALR.HB, JR.HB, ERET, or DERET. Further, the operation is **UNPREDICTABLE** if the mapping of the current instruction stream is modified.

Control Transfer Instructions (CTIs) should not be placed in branch delay slots or Release 6 forbidden slots. CTIs include all branches and jumps, NAL, ERET, ERETNC, DERET, WAIT, and PAUSE.

Pre-Release 6: Processor operation is **UNPREDICTABLE** if a control transfer instruction (CTI) is placed in the delay slot of a branch or jump.

Release 6: If a control transfer instruction (CTI) is executed in the delay slot of a branch or jump, Release 6 implementations are required to signal a Reserved Instruction exception.

Jump-and-Link Restartability: Register specifiers *rs* and *rd* must not be equal, because such an instruction does not have the same effect when re-executed. The result of executing such an instruction is **UNPREDICTABLE**. This restriction permits an exception handler to resume execution by re-executing the branch when an exception occurs in the delay slot.

Restrictions Related to Multiple Instruction Sets: This instruction can change the active instruction set, if more than one instruction set is implemented.

If only one instruction set is implemented, then the effective target address must obey the alignment rules of the instruction set. If multiple instruction sets are implemented, the effective target address must obey the alignment rules of the intended instruction set of the target address as specified by the bit 0 or GPR *rs*.

For processors that do not implement the microMIPS32/64 ISA, the effective target address in GPR *rs* must be naturally-aligned. For processors that do not implement the MIPS16 ASE nor microMIPS32/64 ISA, if either of the two least-significant bits are not zero, an Address Error exception occurs when the branch target is subsequently fetched as an instruction.

For processors that do implement the MIPS16 ASE or microMIPS32/64 ISA, if bit 0 is zero and bit 1 is one, an Address Error exception occurs when the jump target is subsequently fetched as an instruction.

Availability and Compatibility:

Release 6 maps JR and JR.HB to JALR and JALR.HB with *rd* = 0:

Pre-Release 6, JR.HB and JALR.HB were distinct instructions, both with primary opcode SPECIAL, but with distinct function codes.

Release 6: JR.HB is defined to be JALR.HB with the destination register specifier *rd* set to 0. The primary opcode and function field are the same for JR.HB and JALR.HB. The pre-Release 6 instruction encoding for JR.HB is removed in Release 6.

Release 6 assemblers should accept the JR and JR.HB mnemonics, mapping them to the Release 6 instruction encodings.

Operation:

```

I: temp ← GPR[rs]
   GPR[rd] ← PC + 8
I+1: if (Config3ISA = 0) and (Config1CA = 0) then
      PC ← temp
    else
      PC ← tempGPREN-1..1 || 0
      ISAMode ← temp0
    endif
   ClearHazards()

```

Exceptions:

None

Programming Notes:

This branch-and-link instruction can select a register for the return link; other link instructions use GPR 31. The

default register for GPR *rd*, if omitted in the assembly language instruction, is GPR 31.

Release 6 JR.HB *rs* is implemented as JALR.HB *r0, rs*. For example, as JALR.HB with the destination set to the zero register, *r0*.

This instruction implements the final step in clearing execution and instruction hazards before execution continues. A hazard is created when a Coprocessor 0 or TLB write affects execution or the mapping of the instruction stream, or after a write to the instruction stream. When such a situation exists, software must explicitly indicate to hardware that the hazard should be cleared. Execution hazards alone can be cleared with the EHB instruction. Instruction hazards can only be cleared with a JR.HB, JALR.HB, or ERET instruction. These instructions cause hardware to clear the hazard before the instruction at the target of the jump is fetched. Note that because these instructions are encoded as jumps, the process of clearing an instruction hazard can often be included as part of a call (JALR) or return (JR) sequence, by simply replacing the original instructions with the HB equivalent.

Example: Clearing hazards due to an ASID change

```

/*
 * Code used to modify ASID and call a routine with the new
 * mapping established.
 *
 * a0 = New ASID to establish
 * a1 = Address of the routine to call
 */
mfc0   v0, C0_EntryHi      /* Read current ASID */
li     v1, ~M_EntryHiASID /* Get negative mask for field */
and    v0, v0, v1          /* Clear out current ASID value */
or     v0, v0, a0          /* OR in new ASID value */
mtc0   v0, C0_EntryHi      /* Rewrite EntryHi with new ASID */
jalr.hb a1                 /* Call routine, clearing the hazard */

```

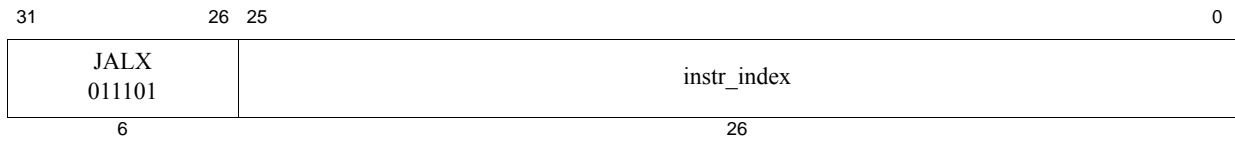
Format: JALX target

MIPS32 with (microMIPS or MIPS16e), removed in Release 6

Purpose: Jump and Link Exchange

To execute a procedure call within the current 256 MB-aligned region and change the *ISA Mode* from MIPS32 to microMIPS32 or MIPS16e.

Description:

Place the return address link in GPR 31. The return link is the address of the second instruction following the branch, at which location execution continues after a procedure call. The value stored in GPR 31 bit 0 reflects the current value of the *ISA Mode* bit.

This is a PC-region branch (not PC-relative); the effective target address is in the “current” 256 MB-aligned region. The low 28 bits of the target address is the *instr_index* field shifted left 2 bits. The remaining upper bits are the corresponding bits of the address of the instruction in the delay slot (not the branch itself).

Jump to the effective target address, toggling the *ISA Mode* bit. Execute the instruction that follows the jump, in the branch delay slot, before executing the jump itself.

Restrictions:

This instruction only supports 32-bit aligned branch target addresses.

Control Transfer Instructions (CTIs) should not be placed in branch delay slots. CTIs include all branches and jumps, NAL, ERET, ERETNC, DERET, WAIT, and PAUSE.

Processor operation is **UNPREDICTABLE** if a control transfer instruction (CTI) is placed in the delay slot of a branch or jump.

Availability and Compatibility:

If the microMIPS base architecture is not implemented and the MIPS16e ASE is not implemented, a Reserved Instruction exception is initiated.

The JALX instruction has been removed in Release 6. Pre-Release 6 code using JALX cannot run on Release 6 by trap-and-emulate. Equivalent functionality is provided by the JIALC instruction added by Release 6.

Operation:

```

I:    GPR[31] ← PC + 8
I+1:  PC ← PCGPRLEN-1..28 || instr_index || 02
      ISAMode ← (not ISAMode)

```

Exceptions:

None

Programming Notes:

Forming the branch target address by concatenating PC and index bits rather than adding a signed offset to the PC is an advantage if all program code addresses fit into a 256 MB region aligned on a 256 MB boundary. It allows a branch from anywhere in the region to anywhere in the region, an action not allowed by a signed relative offset.

This definition creates the following boundary case: When the branch instruction is in the last word of a 256 MB

region, it can branch only to the following 256 MB region containing the branch delay slot.

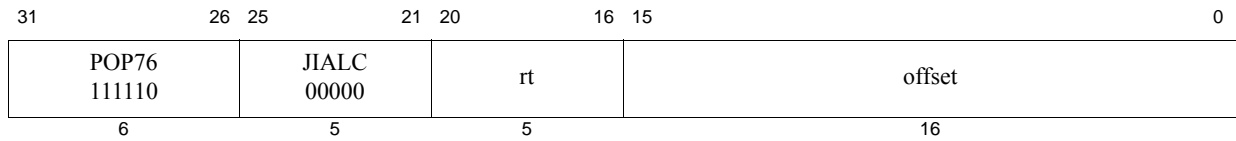

Format: JIALC *rt*, *offset*

MIPS32 Release 6

Purpose: Jump Indexed and Link, Compact

Description: $GPR[31] \leftarrow PC+4$, $PC \leftarrow (GPR[rt] + sign_extend(offset))$

The jump target is formed by sign extending the offset field of the instruction and adding it to the contents of GPR *rt*.

The offset is NOT shifted, that is, each bit of the offset is added to the corresponding bit of the GPR.

Places the return address link in GPR 31. The return link is the address of the following instruction, where execution continues after a procedure call returns.

For processors that do not implement the MIPS16e or microMIPS ISA:

- Jump to the effective target address derived from GPR *rt* and the offset. If the target address is not 4-byte aligned, an Address Error exception will occur when the target address is fetched.

For processors that do implement the MIPS16e or microMIPS ISA:

- Jump to the effective target address derived from GPR *rt* and the offset. Set the ISA Mode bit to bit 0 of the effective address. Set bit 0 of the target address to zero. If the target ISA Mode bit is 0 and the target address is not 4-byte aligned, an Address Error exception will occur when the target instruction is fetched.

Compact jumps do not have delay slots. The instruction after the jump is NOT executed when the jump is executed.

Restrictions:

This instruction is an unconditional, always taken, compact jump, and hence has neither a delay slot nor a forbidden slot. The instruction after the jump is not executed when the jump is executed.

The register specifier may be set to the link register \$31, because compact jumps do not have the restartability issues of jumps with delay slots. However, this is not common programming practice.

Availability and Compatibility:

This instruction is introduced by and required as of Release 6.

Release 6 instructions JIALC and BNEZC differ only in the *rs* field, instruction bits 21-25. JIALC and BNEZC occupy the same encoding as pre-Release 6 instruction encoding SDC2, which is recoded in Release 6.

Exceptions:

None

Operation:

```
temp ← GPR[rt] + sign_extend(offset)
GPR[31] ← PC + 4
if (Config3ISA = 0) and (Config1CA = 0) then
    PC ← temp
else
    PC ← (tempGPREN-1..1 || 0)
    ISAMode ← temp0
endif
```

Programming Notes:

JIALC does NOT shift the offset before adding it to the register. This can be used to eliminate tags in the least significant bits that would otherwise produce misalignment. It also allows JIALC to be used as a substitute for the JALX instruction, removed in Release 6, where the lower bits of the target PC, formed by the addition of $GPR[rt]$ and the unshifted offset, specify the target ISA mode.

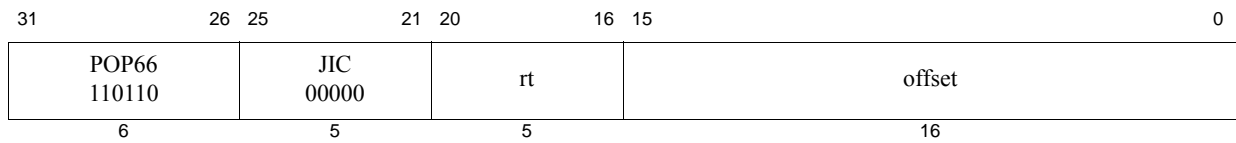

Format: JIC *rt*, *offset*

MIPS32 Release 6

Purpose: Jump Indexed, Compact

Description: $PC \leftarrow (GPR[rt] + \text{sign_extend}(\text{offset}))$

The branch target is formed by sign extending the offset field of the instruction and adding it to the contents of GPR *rt*.

The offset is NOT shifted, that is, each bit of the offset is added to the corresponding bit of the GPR.

For processors that do not implement the MIPS16e or microMIPS ISA:

- Jump to the effective target address derived from GPR *rt* and the offset. If the target address is not 4-byte aligned, an Address Error exception will occur when the target address is fetched.

For processors that do implement the MIPS16e or microMIPS ISA:

- Jump to the effective target address derived from GPR *rt* and the offset. Set the ISA Mode bit to bit 0 of the effective address. Set bit 0 of the target address to zero. If the target ISA Mode bit is 0 and the target address is not 4-byte aligned, an Address Error exception will occur when the target instruction is fetched.

Compact jumps do not have a delay slot. The instruction after the jump is NOT executed when the jump is executed.

Restrictions:

This instruction is an unconditional, always taken, compact jump, and hence has neither a delay slot nor a forbidden slot. The instruction after the jump is not executed when the jump is executed.

Availability and Compatibility:

This instruction is introduced by and required as of Release 6.

Release 6 instructions JIC and BEQZC differ only in the *rs* field. JIC and BEQZC occupy the same encoding as pre-Release 6 instruction LDC2, which is recoded in Release 6.

Exceptions:

None

Operation:

```
temp ← GPR[rt] + sign_extend(offset)
if (Config3ISA = 0) and (Config1CA = 0) then
    PC ← temp
else
    PC ← (tempGPREN-1..1 || 0)
    ISAMode ← temp0
endif
```

Programming Notes:

JIC does NOT shift the offset before adding it the register. This can be used to eliminate tags in the least significant bits that would otherwise produce misalignment. It also allows JIALC to be used as a substitute for the JALX instruction, removed in Release 6, where the lower bits of the target PC, formed by the addition of GPR[*rt*] and the unshifted offset, specify the target ISAMode.

pre-Release 6:

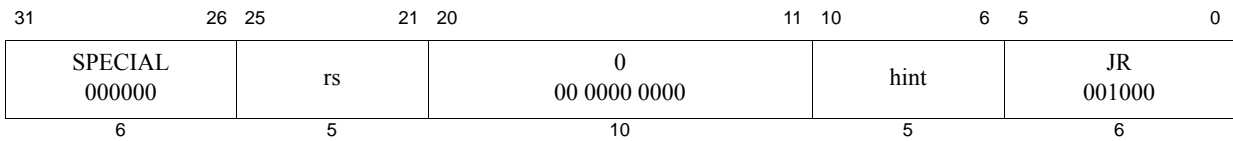

Release 6:

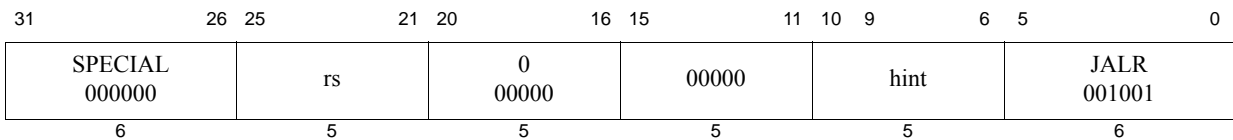
**Format:** JR rs**MIPS32**
Assembly idiom MIPS32 Release 6**Purpose:** Jump Register

To execute a branch to an instruction address in a register

Description: $PC \leftarrow GPR[rs]$ Jump to the effective target address in GPR *rs*. Execute the instruction following the jump, in the branch delay slot, before jumping.*For processors that do not implement the MIPS16e or microMIPS ISA:*

- Jump to the effective target address in GPR *rs*. If the target address is not 4-byte aligned, an Address Error exception will occur when the target address is fetched.

For processors that do implement the MIPS16e or microMIPS ISA:

- Jump to the effective target address in GPR *rs*. Set the ISA Mode bit to the value in GPR *rs* bit 0. Set bit 0 of the target address to zero. If the target ISA Mode bit is 0 and the target address is not 4-byte aligned, an Address Error exception will occur when the target instruction is fetched.

Restrictions:*Control Transfer Instructions (CTIs) should not be placed in branch delay slots or Release 6 forbidden slots. CTIs include all branches and jumps, NAL, ERET, ERETNC, DERET, WAIT, and PAUSE.*Pre-Release 6: Processor operation is **UNPREDICTABLE** if a control transfer instruction (CTI) is placed in the delay slot of a branch or jump.

Release 6: If a control transfer instruction (CTI) is executed in the delay slot of a branch or jump, Release 6 implementations are required to signal a Reserved Instruction exception.

Restrictions Related to Multiple Instruction Sets: This instruction can change the active instruction set, if more than one instruction set is implemented.If only one instruction set is implemented, then the effective target address must obey the alignment rules of the instruction set. If multiple instruction sets are implemented, the effective target address must obey the alignment rules of the intended instruction set of the target address as specified by the bit 0 or GPR *rs*.For processors that do not implement the microMIPS ISA, the effective target address in GPR *rs* must be naturally-aligned. For processors that do not implement the MIPS16e ASE or microMIPS ISA, if either of the two least-significant bits are not zero, an Address Error exception occurs when the branch target is subsequently fetched as an instruction.

For processors that do implement the MIPS16e ASE or microMIPS ISA, if bit 0 is zero and bit 1 is one, an Address Error exception occurs when the jump target is subsequently fetched as an instruction.

In release 1 of the architecture, the only defined hint field value is 0, which sets default handling of JR. In Release 2 of the architecture, bit 10 of the hint field is used to encode an instruction hazard barrier. See the [JR.HB](#) instruction description for additional information.

Availability and Compatibility:

Release 6 maps JR and JR.HB to JALR and JALR.HB with rd = 0:

Pre-Release 6, JR and JALR were distinct instructions, both with primary opcode SPECIAL, but with distinct function codes.

Release 6: JR is defined to be JALR with the destination register specifier *rd* set to 0. The primary opcode and function field are the same for JR and JALR. The pre-Release 6 instruction encoding for JR is removed in Release 6.

Release 6 assemblers should accept the JR and JR.HB mnemonics, mapping them to the Release 6 instruction encodings.

Operation:

```

I: temp ← GPR[rs]
I+1:if (Config3ISA = 0) and (Config1CA = 0) then
    PC ← temp
    else
    PC ← tempGPREN-1..1 || 0
    ISAMode ← temp0
endif

```

Exceptions:

None

Programming Notes:

Software should use the value 31 for the *rs* field of the instruction word on return from a JAL, JALR, or BGEZAL, and should use a value other than 31 for remaining uses of JR.

pre-Release 6:

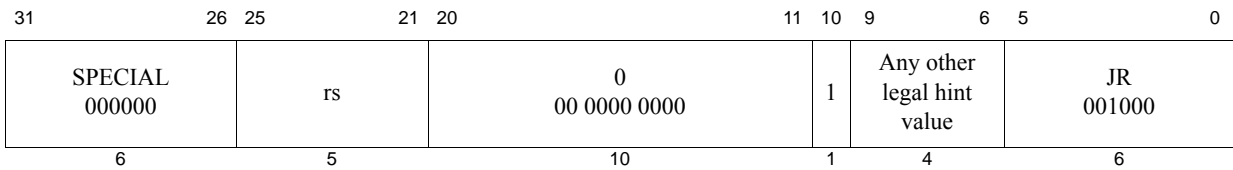

Release 6:

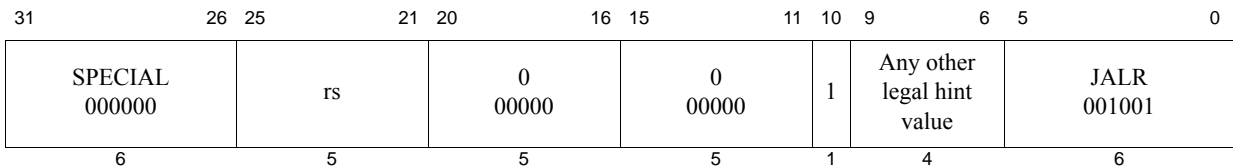
**Format:** JR.HB rs**MIPS32 Release 2
Assembly idiom Release 6****Purpose:** Jump Register with Hazard Barrier

To execute a branch to an instruction address in a register and clear all execution and instruction hazards.

Description: $PC \leftarrow GPR[rs]$, clear execution and instruction hazardsJump to the effective target address in GPR *rs*. Execute the instruction following the jump, in the branch delay slot, before jumping.*For processors that do not implement the MIPS16e or microMIPS ISA:*

- Jump to the effective target address in GPR *rs*. If the target address is not 4-byte aligned, an Address Error exception will occur when the target address is fetched.

For processors that do implement the MIPS16e or microMIPS ISA:

- Jump to the effective target address in GPR *rs*. Set the ISA Mode bit to the value in GPR *rs* bit 0. Set bit 0 of the target address to zero. If the target ISA Mode bit is 0 and the target address is not 4-byte aligned, an Address Error exception will occur when the target instruction is fetched.

JR.HB implements a software barrier that resolves all execution and instruction hazards created by Coprocessor 0 state changes (for Release 2 implementations, refer to the SYNCI instruction for additional information on resolving instruction hazards created by writing the instruction stream). The effects of this barrier are seen starting with the instruction fetch and decode of the instruction at the PC to which the JR.HB instruction jumps. An equivalent barrier is also implemented by the ERET instruction, but that instruction is only available if access to Coprocessor 0 is enabled, whereas JR.HB is legal in all operating modes.

This instruction clears both execution and instruction hazards. Refer to the EHB instruction description for the method of clearing execution hazards alone.

JR.HB uses bit 10 of the instruction (the upper bit of the hint field) to denote the hazard barrier operation.

Restrictions:

JR.HB does not clear hazards created by any instruction that is executed in the delay slot of the JR.HB. Only hazards created by instructions executed before the JR.HB are cleared by the JR.HB.

After modifying an instruction stream mapping or writing to the instruction stream, execution of those instructions has **UNPREDICTABLE** behavior until the hazard has been cleared with JALR.HB, JR.HB, ERET, or DERET. Further, the operation is **UNPREDICTABLE** if the mapping of the current instruction stream is modified.

Control Transfer Instructions (CTIs) should not be placed in branch delay slots or Release 6 forbidden slots. CTIs

include all branches and jumps, NAL, ERET, ERETNC, DERET, WAIT, and PAUSE.

Pre-Release 6: Processor operation is **UNPREDICTABLE** if a control transfer instruction (CTI) is placed in the delay slot of a branch or jump.

Release 6: If a control transfer instruction (CTI) is executed in the delay slot of a branch or jump, Release 6 implementations are required to signal a Reserved Instruction exception.

Restrictions Related to Multiple Instruction Sets: This instruction can change the active instruction set, if more than one instruction set is implemented.

If only one instruction set is implemented, then the effective target address must obey the alignment rules of the instruction set. If multiple instruction sets are implemented, the effective target address must obey the alignment rules of the intended instruction set of the target address as specified by the bit 0 or GPR *rs*.

For processors that do not implement the microMIPS ISA, the effective target address in GPR *rs* must be naturally-aligned. For processors that do not implement the MIPS16 ASE or microMIPS ISA, if either of the two least-significant bits are not zero, an Address Error exception occurs when the branch target is subsequently fetched as an instruction.

For processors that do implement the MIPS16 ASE or microMIPS ISA, if bit 0 is zero and bit 1 is one, an Address Error exception occurs when the jump target is subsequently fetched as an instruction.

Availability and Compatibility:

Release 6 maps JR and JR.HB to JALR and JALR.HB with rd = 0:

Pre-Release 6, JR.HB and JALR.HB were distinct instructions, both with primary opcode SPECIAL, but with distinct function codes.

Release 6: JR.HB is defined to be JALR.HB with the destination register specifier *rd* set to 0. The primary opcode and function field are the same for JR.HB and JALR.HB. The pre-Release 6 instruction encoding for JR.HB is removed in Release 6.

Release 6 assemblers should accept the JR and JR.HB mnemonics, mapping them to the Release 6 instruction encodings.

Operation:

```

I: temp ← GPR[rs]
I+1:if (Config3ISA = 0) and (Config1CA = 0) then
    PC ← temp
    else
        PC ← tempGPREN-1..1 || 0
        ISAMode ← temp0
    endif
ClearHazards()

```

Exceptions:

None

Programming Notes:

This instruction implements the final step in clearing execution and instruction hazards before execution continues. A hazard is created when a Coprocessor 0 or TLB write affects execution or the mapping of the instruction stream, or after a write to the instruction stream. When such a situation exists, software must explicitly indicate to hardware that the hazard should be cleared. Execution hazards alone can be cleared with the EHB instruction. Instruction hazards can only be cleared with a JR.HB, JALR.HB, or ERET instruction. These instructions cause hardware to clear the hazard before the instruction at the target of the jump is fetched. Note that because these instructions are encoded as jumps, the process of clearing an instruction hazard can often be included as part of a call (JALR) or return (JR)

sequence, by simply replacing the original instructions with the HB equivalent.

Example: Clearing hazards due to an ASID change

```

/*
 * Routine called to modify ASID and return with the new
 * mapping established.
 *
 * a0 = New ASID to establish
 */
mfc0   v0, CO_EntryHi      /* Read current ASID */
li     v1, ~M_EntryHiASID /* Get negative mask for field */
and    v0, v0, v1          /* Clear out current ASID value */
or     v0, v0, a0          /* OR in new ASID value */
mtc0   v0, CO_EntryHi      /* Rewrite EntryHi with new ASID */
jr.hb  ra                  /* Return, clearing the hazard */
nop

```

Example: Making a write to the instruction stream visible

```

/*
 * Routine called after new instructions are written to
 * make them visible and return with the hazards cleared.
 */
{Synchronize the caches - see the SYNCI and CACHE instructions}
sync   v0, v0              /* Force memory synchronization */
jr.hb  ra                  /* Return, clearing the hazard */
nop

```

Example: Clearing instruction hazards in-line

```

la     AT, 10f
jr.hb AT                   /* Jump to next instruction, clearing */
nop    /* hazards */
10:

```

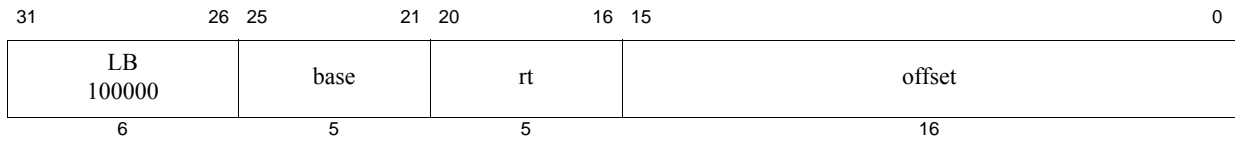

Format: LB *rt*, *offset*(*base*)

MIPS32

Purpose: Load Byte

To load a byte from memory as a signed value.

Description: $GPR[rt] \leftarrow \text{memory}[GPR[base] + \text{offset}]$

The contents of the 8-bit byte at the memory location specified by the effective address are fetched, sign-extended, and placed in GPR *rt*. The 16-bit signed *offset* is added to the contents of GPR *base* to form the effective address.

Restrictions:

None

Operation:

```

vAddr ← sign_extend(offset) + GPR[base]
(pAddr, CCA) ← AddressTranslation (vAddr, DATA, LOAD)
pAddr ← pAddrPSIZE-1..2 || (pAddr1..0 xor ReverseEndian2)
memword ← LoadMemory (CCA, BYTE, pAddr, vAddr, DATA)
byte ← vAddr1..0 xor BigEndianCPU2
GPR[rt] ← sign_extend(memword7+8*byte..8*byte)

```

Exceptions:

TLB Refill, TLB Invalid, Address Error, Watch

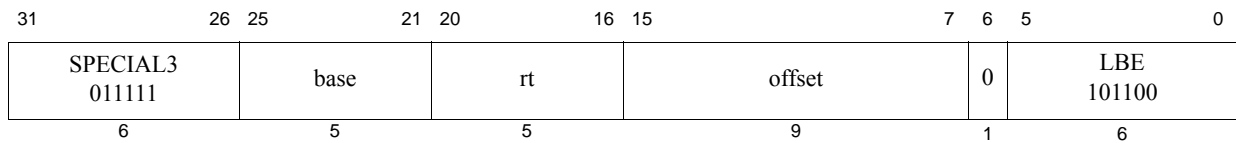

Format: LBE *rt*, *offset*(*base*)

MIPS32

Purpose: Load Byte EVA

To load a byte as a signed value from user mode virtual address space when executing in kernel mode.

Description: $GPR[rt] \leftarrow \text{memory}[GPR[base] + \text{offset}]$

The contents of the 8-bit byte at the memory location specified by the effective address are fetched, sign-extended, and placed in GPR *rt*. The 9-bit signed *offset* is added to the contents of GPR *base* to form the effective address.

The LBE instruction functions the same as the LB instruction, except that address translation is performed using the user mode virtual address space mapping in the TLB when accessing an address within a memory segment configured to use the MUSUK access mode and executing in kernel mode. Memory segments using UUSK or MUSK access modes are also accessible. Refer to Volume III, Enhanced Virtual Addressing section for additional information.

Implementation of this instruction is specified by the *Config5_{EVA}* field being set to one.

Restrictions:

Only usable when access to Coprocessor0 is enabled and accessing an address within a segment configured using UUSK, MUSK or MUSUK access mode.

Operation:

```
vAddr ← sign_extend(offset) + GPR[base]
(pAddr, CCA) ← AddressTranslation(vAddr, DATA, LOAD)
pAddr ← pAddrPSIZE-1..2 || (pAddr1..0 xor ReverseEndian2)
memword ← LoadMemory(CCA, BYTE, pAddr, vAddr, DATA)
byte ← vAddr1..0 xor BigEndianCPU2
GPR[rt] ← sign_extend(memword7+8*byte..8*byte)
```

Exceptions:

TLB Refill, TLB Invalid

Bus Error, Address Error, Watch, Reserved Instruction, Coprocessor Unusable

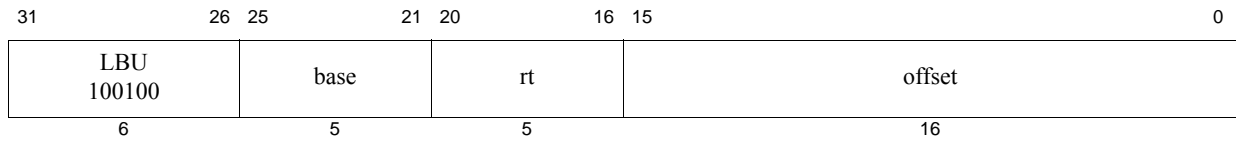

Format: LBU *rt*, *offset*(*base*)

MIPS32

Purpose: Load Byte Unsigned

To load a byte from memory as an unsigned value

Description: $GPR[rt] \leftarrow \text{memory}[GPR[base] + \text{offset}]$

The contents of the 8-bit byte at the memory location specified by the effective address are fetched, zero-extended, and placed in GPR *rt*. The 16-bit signed *offset* is added to the contents of GPR *base* to form the effective address.

Restrictions:

None

Operation:

```

vAddr ← sign_extend(offset) + GPR[base]
(pAddr, CCA) ← AddressTranslation (vAddr, DATA, LOAD)
pAddr ← pAddr_PSIZE-1..2 || (pAddr_1..0 xor ReverseEndian2)
memword ← LoadMemory (CCA, BYTE, pAddr, vAddr, DATA)
byte ← vAddr_1..0 xor BigEndianCPU2
GPR[rt] ← zero_extend(memword7+8*byte..8*byte)

```

Exceptions:

TLB Refill, TLB Invalid, Address Error, Watch

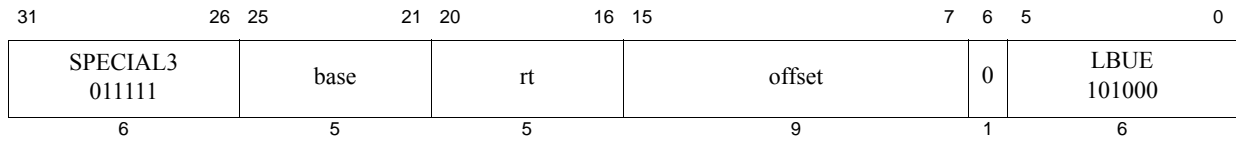

Format: LBUE *rt*, *offset*(*base*)

MIPS32

Purpose: Load Byte Unsigned EVA

To load a byte as an unsigned value from user mode virtual address space when executing in kernel mode.

Description: $GPR[rt] \leftarrow \text{memory}[GPR[base] + \text{offset}]$

The contents of the 8-bit byte at the memory location specified by the effective address are fetched, zero-extended, and placed in GPR *rt*. The 9-bit signed *offset* is added to the contents of GPR *base* to form the effective address.

The LBUE instruction functions the same as the LBU instruction, except that address translation is performed using the user mode virtual address space mapping in the TLB when accessing an address within a memory segment configured to use the MUSUK access mode. Memory segments using UUSK or MUSK access modes are also accessible. Refer to Volume III, Enhanced Virtual Addressing section for additional information.

Implementation of this instruction is specified by the *Config5_{EVA}* field being set to one.

Restrictions:

Only usable when access to Coprocessor0 is enabled and accessing an address within a segment configured using UUSK, MUSK or MUSUK access mode.

Operation:

```
vAddr ← sign_extend(offset) + GPR[base]
(pAddr, CCA) ← AddressTranslation(vAddr, DATA, LOAD)
pAddr ← pAddrPSIZE-1..2 || (pAddr1..0 xor ReverseEndian2)
memword ← LoadMemory(CCA, BYTE, pAddr, vAddr, DATA)
byte ← vAddr1..0 xor BigEndianCPU2
GPR[rt] ← zero_extend(memword7+8*byte..8*byte)
```

Exceptions:

TLB Refill, TLB Invalid, Bus Error, Address Error, Watch, Reserved Instruction, Coprocessor Unusable

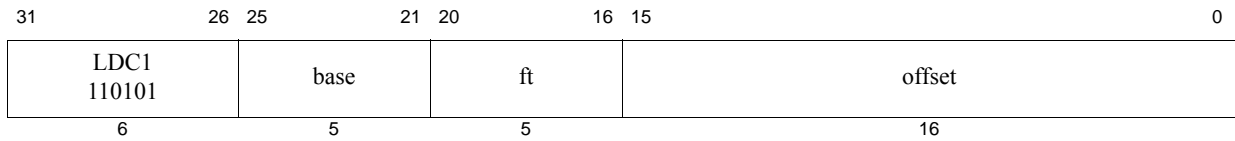

Format: LDC1 ft, offset(base)

MIPS32

Purpose: Load Doubleword to Floating Point

To load a doubleword from memory to an FPR.

Description: $FPR[ft] \leftarrow memory[GPR[base] + offset]$

The contents of the 64-bit doubleword at the memory location specified by the aligned effective address are fetched and placed in FPR *ft*. The 16-bit signed *offset* is added to the contents of GPR *base* to form the effective address.

Restrictions:

Pre-Release 6: An Address Error exception occurs if $EffectiveAddress_{2..0} \neq 0$ (not doubleword-aligned).

Release 6 allows hardware to provide address misalignment support in lieu of requiring natural alignment.

Note: The pseudocode is not completely adapted for Release 6 misalignment support as the handling is implementation dependent.

Operation:

```

vAddr ← sign_extend(offset) + GPR[base]
(pAddr, CCA) ← AddressTranslation(vAddr, DATA, LOAD)
paddr ← paddr xor ((BigEndianCPU xor ReverseEndian) || 02)
memlsw ← LoadMemory(CCA, WORD, pAddr, vAddr, DATA)
paddr ← paddr xor 0b100
memmsw ← LoadMemory(CCA, WORD, pAddr, vAddr+4, DATA)
memdoubleword ← memmsw || memlsw
StoreFPR(ft, UNINTERPRETED_DOUBLEWORD, memdoubleword)

```

Exceptions:

Coprocessor Unusable, Reserved Instruction, TLB Refill, TLB Invalid, Address Error, Watch

pre-Release 6

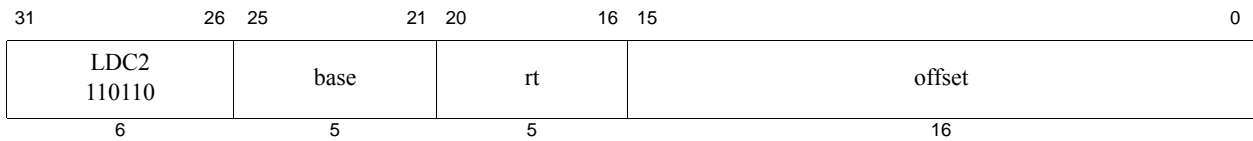

Release 6

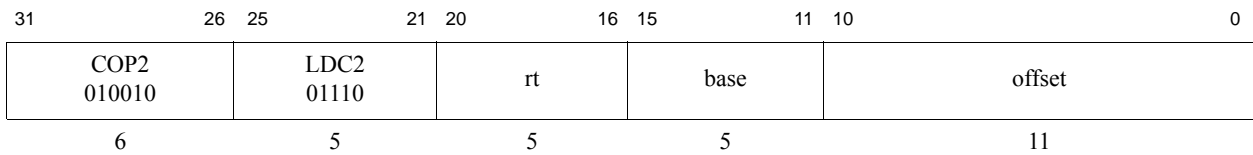
**Format:** LDC2 *rt*, *offset*(*base*)**MIPS32****Purpose:** Load Doubleword to Coprocessor 2

To load a doubleword from memory to a Coprocessor 2 register.

Description: $CPR[2,rt,0] \leftarrow \text{memory}[GPR[base] + offset]$

The contents of the 64-bit doubleword at the memory location specified by the aligned effective address are fetched and placed in Coprocessor 2 register *rt*. The signed *offset* is added to the contents of GPR *base* to form the effective address.

Restrictions:Pre-Release 6: An Address Error exception occurs if $\text{EffectiveAddress}_{2..0} \neq 0$ (not doubleword-aligned).

Release 6 allows hardware to provide address misalignment support in lieu of requiring natural alignment.

Note: The pseudocode is not completely adapted for Release 6 misalignment support as the handling is implementation dependent.

Availability and Compatibility:

This instruction has been recoded for Release 6.

Operation:

```

vAddr ← sign_extend(offset) + GPR[base]
(pAddr, CCA) ← AddressTranslation(vAddr, DATA, LOAD)
paddr ← paddr xor ((BigEndianCPU xor ReverseEndian) || 02)
memlsw ← LoadMemory(CCA, WORD, pAddr, vAddr, DATA)
paddr ← paddr xor 0b100
memmsw ← LoadMemory(CCA, WORD, pAddr, vAddr+4, DATA)
←memlsw
memmsw

```

Exceptions:

Coprocessor Unusable, Reserved Instruction, TLB Refill, TLB Invalid, Address Error, Watch

Programming Notes:

Release 6 implements a 9-bit offset, whereas all release levels lower than Release 6 implement a 16-bit offset.

Programming Notes:

As shown in the instruction drawing above, Release 6 implements an 11-bit offset, whereas all release levels lower

than Release 6 of the MIPS architecture implement a 16-bit offset.

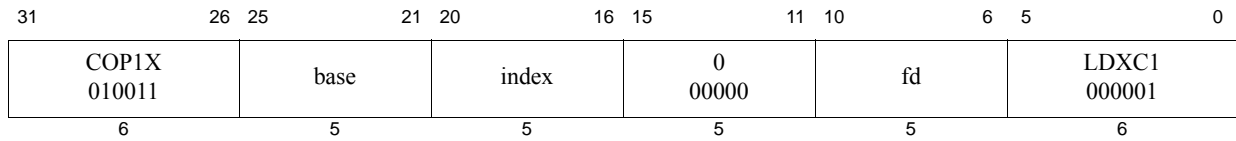

Format: LDXC1 fd, index(base)

MIPS32 Release 2 removed in Release 6

Purpose: Load Doubleword Indexed to Floating Point

To load a doubleword from memory to an FPR (GPR+GPR addressing)

Description: $FPR[fd] \leftarrow \text{memory}[GPR[base] + GPR[index]]$

The contents of the 64-bit doubleword at the memory location specified by the aligned effective address are fetched and placed in FPR *fd*. The contents of GPR *index* and GPR *base* are added to form the effective address.

Restrictions:

An Address Error exception occurs if $\text{EffectiveAddress}_{2..0} \neq 0$ (not doubleword-aligned).

Availability and Compatibility:

This instruction has been removed in Release 6.

Required in all versions of MIPS64 since MIPS64 Release 1. Not available in MIPS32 Release 1. Required in MIPS32 Release 2 and all subsequent versions of MIPS32. When required, required whenever FPU is present, whether a 32-bit or 64-bit FPU, whether in 32-bit or 64-bit FP Register Mode ($FIR_{F64}=0$ or 1, $Status_{FR}=0$ or 1).

Operation:

```

vAddr ← GPR[base] + GPR[index]
if vAddr2..0 ≠ 03 then
    SignalException(AddressError)
endif
(pAddr, CCA) ← AddressTranslation(vAddr, DATA, LOAD)
paddr ← paddr xor ((BigEndianCPU xor ReverseEndian) || 02)
memlsw ← LoadMemory(CCA, WORD, pAddr, vAddr, DATA)
paddr ← paddr xor 0b100
memmsw ← LoadMemory(CCA, WORD, pAddr, vAddr+4, DATA)
memdoubleword ← memmsw || memlsw
StoreFPR(fd, UNINTERPRETED_DOUBLEWORD, memdoubleword)

```

Exceptions:

TLB Refill, TLB Invalid, Address Error, Reserved Instruction, Coprocessor Unusable, Watch

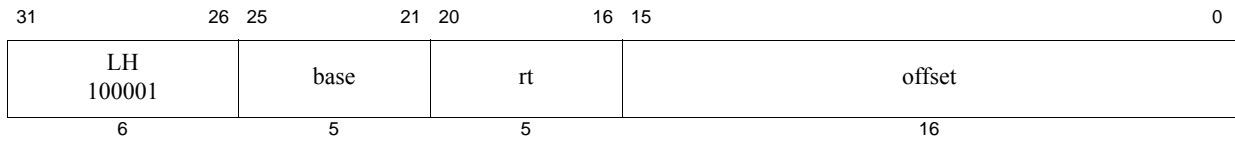

Format: LH *rt*, *offset*(*base*)

MIPS32

Purpose: Load Halfword

To load a halfword from memory as a signed value

Description: $GPR[rt] \leftarrow \text{memory}[GPR[base] + \text{offset}]$

The contents of the 16-bit halfword at the memory location specified by the aligned effective address are fetched, sign-extended, and placed in GPR *rt*. The 16-bit signed *offset* is added to the contents of GPR *base* to form the effective address.

Restrictions:

Pre-Release 6: The effective address must be naturally-aligned. If the least-significant bit of the address is non-zero, an Address Error exception occurs.

Release 6 allows hardware to provide address misalignment support in lieu of requiring natural alignment.

Note: The pseudocode is not completely adapted for Release 6 misalignment support as the handling is implementation dependent.

Operation:

```

vAddr ← sign_extend(offset) + GPR[base]
(pAddr, CCA) ← AddressTranslation(vAddr, DATA, LOAD)
pAddr ← pAddr_PSIZE-1..2 || (pAddr_1..0 xor (ReverseEndian || 0))
memword ← LoadMemory(CCA, HALFWORD, pAddr, vAddr, DATA)
byte ← vAddr_1..0 xor (BigEndianCPU || 0)
GPR[rt] ← sign_extend(memword_15+8*byte..8*byte)

```

Exceptions:

TLB Refill, TLB Invalid, Bus Error, Address Error, Watch

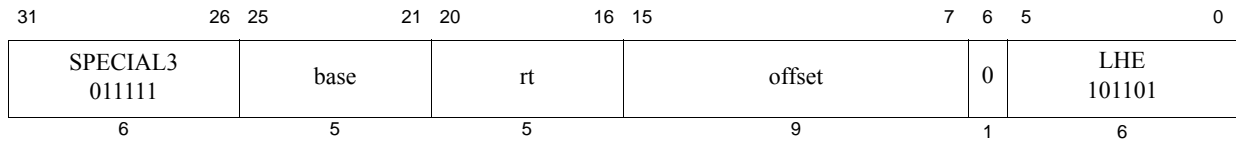

Format: LHE *rt*, *offset*(*base*)

MIPS32

Purpose: Load Halfword EVA

To load a halfword as a signed value from user mode virtual address space when executing in kernel mode.

Description: $GPR[rt] \leftarrow \text{memory}[GPR[base] + \text{offset}]$

The contents of the 16-bit halfword at the memory location specified by the aligned effective address are fetched, sign-extended, and placed in GPR *rt*. The 9-bit signed *offset* is added to the contents of GPR *base* to form the effective address.

The LHE instruction functions the same as the LH instruction, except that address translation is performed using the user mode virtual address space mapping in the TLB when accessing an address within a memory segment configured to use the MUSUK access mode. Memory segments using UUSK or MUSK access modes are also accessible. Refer to Volume III, Enhanced Virtual Addressing section for additional information.

Implementation of this instruction is specified by the *Config5_{EVA}* field being set to one.

Restrictions:

Only usable when access to Coprocessor0 is enabled and accessing an address within a segment configured using UUSK, MUSK or MUSUK access mode.

Pre-Release 6: The effective address must be naturally-aligned. If the least-significant bit of the address is non-zero, an Address Error exception occurs.

Release 6 allows hardware to provide address misalignment support in lieu of requiring natural alignment.

Note: The pseudocode is not completely adapted for Release 6 misalignment support as the handling is implementation dependent.

Operation:

```

vAddr ← sign_extend(offset) + GPR[base]
(pAddr, CCA) ← AddressTranslation(vAddr, DATA, LOAD)
pAddr ← pAddr_PSIZE-1..2 || (pAddr_1..0 xor (ReverseEndian || 0))
memword ← LoadMemory(CCA, HALFWORD, pAddr, vAddr, DATA)
byte ← vAddr_1..0 xor (BigEndianCPU || 0)
GPR[rt] ← sign_extend(memword_15+8*byte..8*byte)

```

Exceptions:

TLB Refill, TLB Invalid, Bus Error, Address Error

Watch, Reserved Instruction, Coprocessor Unusable

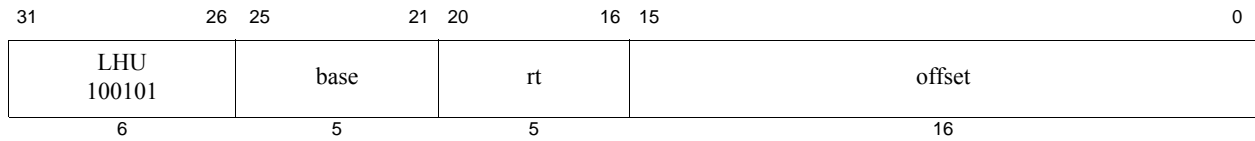

Format: LHU *rt*, *offset*(*base*)

MIPS32

Purpose: Load Halfword Unsigned

To load a halfword from memory as an unsigned value

Description: $GPR[rt] \leftarrow \text{memory}[GPR[base] + \text{offset}]$

The contents of the 16-bit halfword at the memory location specified by the aligned effective address are fetched, zero-extended, and placed in GPR *rt*. The 16-bit signed *offset* is added to the contents of GPR *base* to form the effective address.

Restrictions:

Pre-Release 6: The effective address must be naturally-aligned. If the least-significant bit of the address is non-zero, an Address Error exception occurs.

Release 6 allows hardware to provide address misalignment support in lieu of requiring natural alignment.

Note: The pseudocode is not completely adapted for Release 6 misalignment support as the handling is implementation dependent.

Operation:

```
vAddr ← sign_extend(offset) + GPR[base]
(pAddr, CCA) ← AddressTranslation(vAddr, DATA, LOAD)
pAddr ← pAddr_PSIZE-1..2 || (pAddr_1..0 xor (ReverseEndian || 0))
memword ← LoadMemory(CCA, HALFWORD, pAddr, vAddr, DATA)
byte ← vAddr_1..0 xor (BigEndianCPU || 0)
GPR[rt] ← zero_extend(memword_15+8*byte..8*byte)
```

Exceptions:

TLB Refill, TLB Invalid, Address Error, Watch

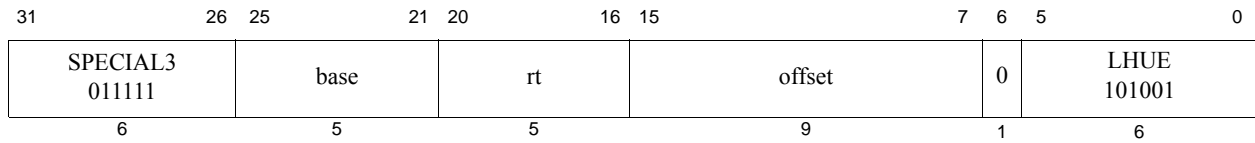

Format: LHUE *rt*, *offset*(*base*)

MIPS32

Purpose: Load Halfword Unsigned EVA

To load a halfword as an unsigned value from user mode virtual address space when executing in kernel mode.

Description: $GPR[rt] \leftarrow \text{memory}[GPR[base] + \text{offset}]$

The contents of the 16-bit halfword at the memory location specified by the aligned effective address are fetched, zero-extended, and placed in GPR *rt*. The 9-bit signed *offset* is added to the contents of GPR *base* to form the effective address.

The LHUE instruction functions the same as the LHU instruction, except that address translation is performed using the user mode virtual address space mapping in the TLB when accessing an address within a memory segment configured to use the MUSUK access mode. Memory segments using UUSK or MUSK access modes are also accessible. Refer to Volume III, Enhanced Virtual Addressing section for additional information.

Implementation of this instruction is specified by the *Config5_{EVA}* field being set to one.

Restrictions:

Only usable when access to Coprocessor0 is enabled and accessing an address within a segment configured using UUSK, MUSK or MUSUK access mode.

Pre-Release 6: The effective address must be naturally-aligned. If the least-significant bit of the address is non-zero, an Address Error exception occurs.

Release 6 allows hardware to provide address misalignment support in lieu of requiring natural alignment.

Note: The pseudocode is not completely adapted for Release 6 misalignment support as the handling is implementation dependent.

Operation:

```

vAddr ← sign_extend(offset) + GPR[base]
(pAddr, CCA) ← AddressTranslation(vAddr, DATA, LOAD)
pAddr ← pAddr_PSIZE-1..2 || (pAddr_1..0 xor (ReverseEndian || 0))
memword ← LoadMemory(CCA, HALFWORD, pAddr, vAddr, DATA)
byte ← vAddr_1..0 xor (BigEndianCPU || 0)
GPR[rt] ← zero_extend(memword_15+8*byte..8*byte)

```

Exceptions:

TLB Refill, TLB Invalid, Bus Error, Address Error, Watch, Reserved Instruction, Coprocessor Unusable

pre-Release 6

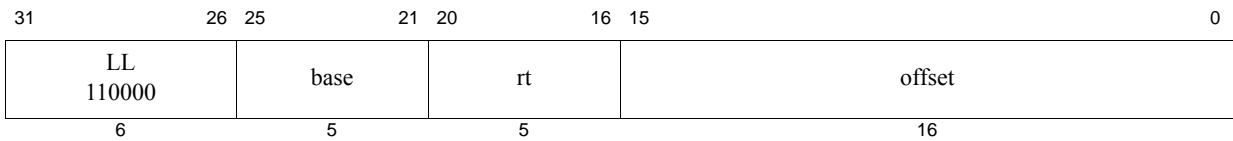

Release 6

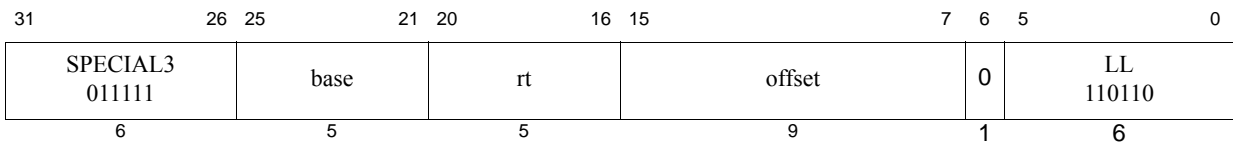
**Format:** LL *rt*, *offset*(*base*)**MIPS32****Purpose:** Load Linked Word

To load a word from memory for an atomic read-modify-write

Description: $GPR[rt] \leftarrow \text{memory}[GPR[base] + \text{offset}]$

The LL and SC instructions provide the primitives to implement atomic read-modify-write (RMW) operations for synchronizable memory locations.

The contents of the 32-bit word at the memory location specified by the aligned effective address are fetched and written into GPR *rt*. The signed *offset* is added to the contents of GPR *base* to form an effective address.

This begins a RMW sequence on the current processor. There can be only one active RMW sequence per processor. When an LL is executed it starts an active RMW sequence replacing any other sequence that was active. The RMW sequence is completed by a subsequent SC instruction that either completes the RMW sequence atomically and succeeds, or does not and fails.

Executing LL on one processor does not cause an action that, by itself, causes an SC for the same block to fail on another processor.

An execution of LL does not have to be followed by execution of SC; a program is free to abandon the RMW sequence without attempting a write.

Restrictions:

The addressed location must be synchronizable by all processors and I/O devices sharing the location; if it is not, the result is **UNPREDICTABLE**. Which storage is synchronizable is a function of both CPU and system implementations. See the documentation of the SC instruction for the formal definition.

The effective address must be naturally-aligned. If either of the 2 least-significant bits of the effective address is non-zero, an Address Error exception occurs.

Providing misaligned support for Release 6 is not a requirement for this instruction.

Availability and Compatibility:

This instruction has been reallocated an opcode in Release 6.

Operation:

```
vAddr ← sign_extend(offset) + GPR[base]
if vAddr1..0 ≠ 02 then
    SignalException(AddressError)
endif
(pAddr, CCA) ← AddressTranslation(vAddr, DATA, LOAD)
```

```
memword ← LoadMemory (CCA, WORD, pAddr, vAddr, DATA)
GPR[rt] ← memword
LLbit ← 1
```

Exceptions:

TLB Refill, TLB Invalid, Address Error, Watch

Programming Notes:

Release 6 implements a 9-bit offset, whereas all release levels lower than Release 6 implement a 16-bit offset.

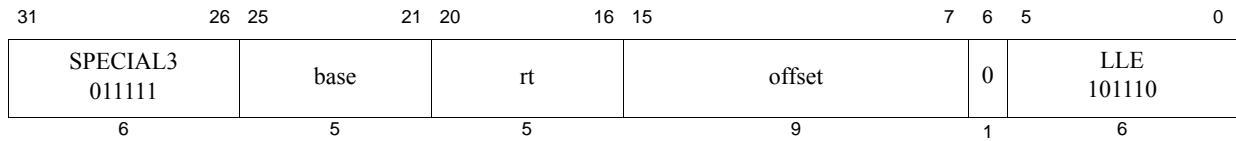

Format: LLE *rt*, *offset*(*base*)

MIPS32

Purpose: Load Linked Word EVA

To load a word from a user mode virtual address when executing in kernel mode for an atomic read-modify-write

Description: $GPR[rt] \leftarrow \text{memory}[GPR[base] + \text{offset}]$

The LLE and SCE instructions provide the primitives to implement atomic read-modify-write (RMW) operations for synchronizable memory locations using user mode virtual addresses while executing in kernel mode.

The contents of the 32-bit word at the memory location specified by the aligned effective address are fetched and written into GPR *rt*. The 9-bit signed *offset* is added to the contents of GPR *base* to form an effective address.

This begins a RMW sequence on the current processor. There can be only one active RMW sequence per processor. When an LLE is executed it starts an active RMW sequence replacing any other sequence that was active. The RMW sequence is completed by a subsequent SCE instruction that either completes the RMW sequence atomically and succeeds, or does not and fails.

Executing LLE on one processor does not cause an action that, by itself, causes an SCE for the same block to fail on another processor.

An execution of LLE does not have to be followed by execution of SCE; a program is free to abandon the RMW sequence without attempting a write.

The LLE instruction functions the same as the LL instruction, except that address translation is performed using the user mode virtual address space mapping in the TLB when accessing an address within a memory segment configured to use the MUSUK access mode. Memory segments using UUSK or MUSK access modes are also accessible. Refer to Volume III, Segmentation Control for additional information.

Implementation of this instruction is specified by the *Config5_{EVA}* field being set to one.

Restrictions:

The addressed location must be synchronizable by all processors and I/O devices sharing the location; if it is not, the result is **UNPREDICTABLE**. Which storage is synchronizable is a function of both CPU and system implementations. See the documentation of the [SCE](#) instruction for the formal definition.

The effective address must be naturally-aligned. If either of the 2 least-significant bits of the effective address is non-zero, an Address Error exception occurs.

Providing misaligned support for Release 6 is not a requirement for this instruction.

Operation:

```

vAddr ← sign_extend(offset) + GPR[base]
if vAddr1..0 ≠ 02 then
    SignalException(AddressError)
endif
(pAddr, CCA) ← AddressTranslation(vAddr, DATA, LOAD)
memword ← LoadMemory(CCA, WORD, pAddr, vAddr, DATA)
←GPR[rt] ← memword
LLbit ← 1

```

Exceptions:

TLB Refill, TLB Invalid, Address Error, Reserved Instruction, Watch, Coprocessor Unusable

Programming Notes:

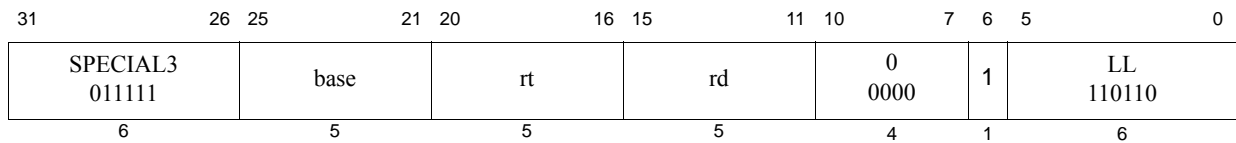

Format: LLWP *rt*, *rd*, (*base*)

MIPS32 Release 6

Purpose: Load Linked Word Paired

To load two words from memory for an atomic read-modify-write, writing a word each to two registers.

Description: $GPR[rd] \leftarrow \text{memory}[GPR[base]]_{63..32}$, $GPR[rt] \leftarrow \text{memory}[GPR[base]]_{31..0}$

The LLWP and SCWP instructions provide primitives to implement a paired word atomic read-modify-write (RMW) operation at a synchronizable memory location.

The 64-bit paired word, as a concatenation of two words, at the memory location specified by the double-word aligned effective address is read. The least significant word is written into GPR *rt*, and the most significant word is written into GPR *rd*.

A paired word read or write occurs as a pair of word reads or writes that is double-word atomic.

The instruction has no offset. The effective address is equal to the contents of GPR *base*.

The execution of LLWP begins a RMW sequence on the current processor. There can be only one active RMW sequence per processor. When an LLWP is executed it starts an active RMW sequence replacing any other sequence that was active. The RMW sequence is completed by a subsequent SCWP instruction that either completes the RMW sequence atomically and succeeds, or does not and fails.

Successful execution of the LLWP results in setting LLbit and writing COP0 *LLAddr*, where LLbit is the least-significant bit of *LLAddr*. *LLAddr* contains the data-type aligned address of the operation, in this case a double-word.

Executing LLWP on one processor does not cause an action that, by itself, causes a store conditional instruction type for the same block to fail on another processor.

An execution of LLWP does not have to be followed by execution of SCWP; a program is free to abandon the RMW sequence without attempting a write.

Restrictions:

The addressed location must be synchronizable by all processors and I/O devices sharing the location; if it is not, the result is **UNPREDICTABLE**. Which storage is synchronizable is a function of both CPU and system implementations. See the documentation of the [SC](#) instruction for the formal definition.

The architecture optionally allows support for Load-Linked and Store-Conditional instruction types in a cacheless processor. Support for cacheless operation is implementation dependent. In this case, *LLAddr* is optional.

Providing misaligned support is not a requirement for this instruction.

Availability and Compatibility

This instruction is introduced by Release 6. It is only present if $Config5_{XNP}=0$.

Operation:

```
vAddr ← GPR[base]
(pAddr, CCA) ← AddressTranslation(vAddr, DATA, LOAD)
// PAIREDWORD: two word data-type that is double-word atomic
memdoubleword ← LoadMemory(CCA, PAIREDWORD, pAddr, vAddr, DATA)
```

```
GPR[rt] ← memdoubleword31..0
GPR[rd] ← memdoubleword63..32
LLAddr ← pAddr // double-word aligned i.e., pAddr2..0 are 0, or not supported.
LLbit ← 1
```

Exceptions:

TLB Refill, TLB Invalid, Reserved Instruction, Address Error, Watch

Programming Notes:

An LLWP instruction for which the two destination registers are the same but non-zero is UNPREDICTABLE. An LLWP with two zero destination registers followed by a SCWP can be used to accomplish a double-word atomic write.

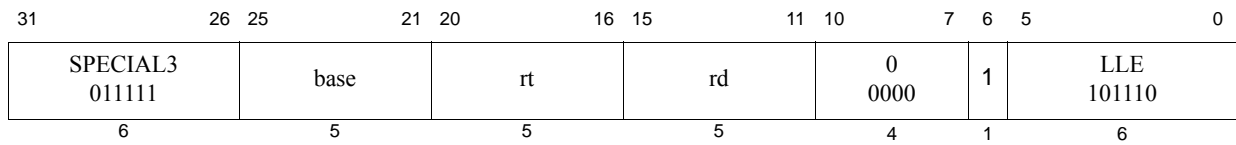

Format: LLWPE *rt*, *rd*, (*base*)

MIPS32 Release 6

Purpose: Load Linked Word Paired EVA

To load two words from memory for an atomic read-modify-write, writing a word each to two registers. The load occurs in kernel mode from user virtual address space.

Description: $GPR[rd] \leftarrow memory[GPR[base]]_{63..32}$, $GPR[rt] \leftarrow memory[GPR[base]]_{31..0}$

The LLWPE and SCWPE instructions provide primitives to implement a paired word atomic read-modify-write (RMW) operation at a synchronizable memory location.

The 64-bit paired word at the memory location specified by the double-word aligned effective address is read. The least significant word is written into GPR *rt*. The most significant word is written into GPR *rd*.

A paired word read or write occurs as a pair of word reads or writes that is double-word atomic.

The instruction has no offset. The effective address is equal to the contents of GPR *base*.

The execution of LLWPE begins a RMW sequence on the current processor. There can be only one active RMW sequence per processor. When an LLWPE is executed it starts an active RMW sequence replacing any other sequence that was active. The RMW sequence is completed by a subsequent SCWPE instruction that either completes the RMW sequence atomically and succeeds, or does not and fails.

Successful execution of the LLWPE results in setting LLbit and writing COPO *LLAddr*, where LLbit is the least-significant bit of *LLAddr*. *LLAddr* contains the data-type aligned address of the operation, in this case a double-word aligned address.

The LLWPE instruction functions the same as the LLWP instruction, except that address translation is performed using the user mode virtual address space mapping in the TLB when accessing an address within a memory segment configured to use the MUSUK access mode. Memory segments using UUSK or MUSK access modes are also accessible. Refer to Volume III, Segmentation Control for additional information.

Executing LLWPE on one processor does not cause an action that, by itself, causes a store conditional instruction type for the same block to fail on another processor.

An execution of LLWPE does not have to be followed by execution of SCWPE; a program is free to abandon the RMW sequence without attempting a write.

Restrictions:

The addressed location must be synchronizable by all processors and I/O devices sharing the location; if it is not, the result is **UNPREDICTABLE**. Which storage is synchronizable is a function of both CPU and system implementations. See the documentation of the SC instruction for the formal definition.

The architecture optionally allows support for Load-Linked and Store-Conditional instruction types in a cacheless processor. Support for cacheless operation is implementation dependent. In this case, *LLAddr* is optional.

Providing misaligned support is not a requirement for this instruction.

Availability and Compatibility

This instruction is introduced by Release 6. It is only present if $Config5_{XNP}=0$ and $Config5_{EVA}=1$.

Operation:

```
vAddr ← GPR[base]
(pAddr, CCA) ← AddressTranslation (vAddr, DATA, LOAD)
// PAIREDWORD: two word data-type that is double-word atomic
memdoubleword ← LoadMemory (CCA, PAIREDWORD, pAddr, vAddr, DATA)
GPR[rt] ← memdoubleword31..0
GPR[rd] ← memdoubleword63..32
LLAddr ← pAddr // double-word aligned i.e., pAddr2..0 are 0, or not supported.
LLbit ← 1
```

Exceptions:

TLB Refill, TLB Invalid, Reserved Instruction, Address Error, Watch, Coprocessor Unusable.

Programming Notes:

An LLWPE instruction for which the two destination registers are the same but non-zero is UNPREDICTABLE. An LLWPE with two zero destination registers followed by a SCWPE can be used to accomplish a double-word atomic write.

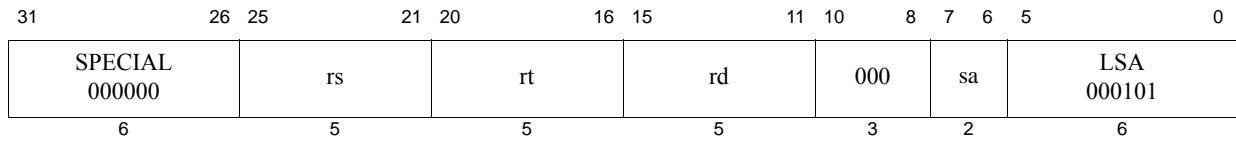

Format: LSA
LSA rd,rs,rt,sa

MIPS32 Release 6

Purpose: Load Scaled Address

Description:

$$\text{GPR}[\text{rd}] \leftarrow \text{sign_extend.32}(\text{GPR}[\text{rs}] \ll (\text{sa}+1) + \text{GPR}[\text{rt}])$$

LSA adds two values derived from registers *rs* and *rt*, with a scaling shift on *rs*. The scaling shift is formed by adding 1 to the 2-bit *sa* field, which is interpreted as unsigned. The scaling left shift varies from 1 to 5, corresponding to multiplicative scaling values of $\times 2$, $\times 4$, $\times 8$, $\times 16$, bytes, or 16, 32, 64, or 128 bits.

Restrictions:

None

Availability and Compatibility:

LSA instruction is introduced by and required as of Release 6.

Operation

$$\text{GPR}[\text{rd}] \leftarrow \text{sign_extend.32}(\text{GPR}[\text{rs}] \ll (\text{sa}+1) + \text{GPR}[\text{rt}])$$

Exceptions:

None

Pre-Release 6

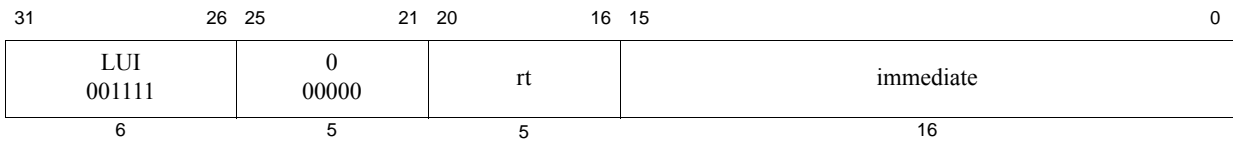

Release 6

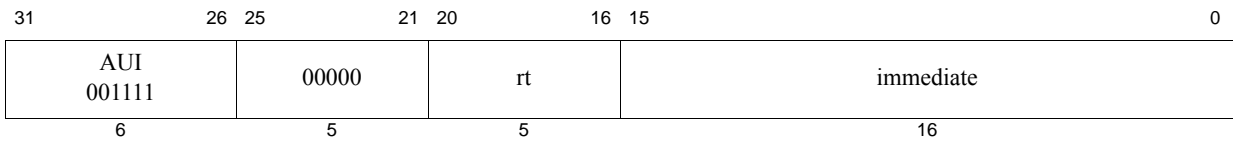
**Format:** LUI *rt*, *immediate*

MIPS32, Assembly Idiom Release 6

Purpose: Load Upper Immediate

To load a constant into the upper half of a word

Description: $GPR[rt] \leftarrow \text{immediate} \parallel 0^{16}$ The 16-bit *immediate* is shifted left 16 bits and concatenated with 16 bits of low-order zeros. The 32-bit result is placed into GPR *rt*.**Restrictions:**

None.

Operation: $GPR[rt] \leftarrow \text{immediate} \parallel 0^{16}$ **Exceptions:**

None

Programming Notes:In Release 6, LUI is an assembly idiom of AUI with *rs*=0.

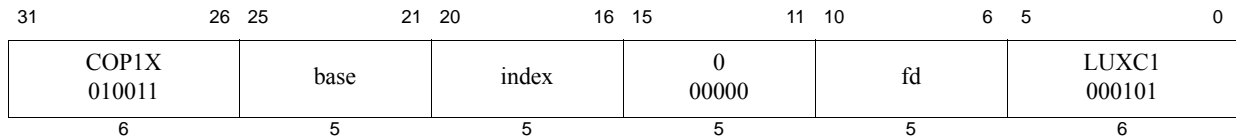

Format: LUXC1 *fd*, *index*(*base*)

MIPS32 Release 2, removed in Release 6

Purpose: Load Doubleword Indexed Unaligned to Floating Point

To load a doubleword from memory to an FPR (GPR+GPR addressing), ignoring alignment

Description: $FPR[fd] \leftarrow memory[(GPR[base] + GPR[index])_{PSIZE-1..3}]$

The contents of the 64-bit doubleword at the memory location specified by the effective address are fetched and placed into the low word of FPR *fd*. The contents of GPR *index* and GPR *base* are added to form the effective address. The effective address is doubleword-aligned; EffectiveAddress_{2..0} are ignored.

Restrictions:

The result of this instruction is **UNPREDICTABLE** if the processor is executing in the *FR*=0 32-bit FPU register model; it is predictable if executing on a 64-bit FPU in the *FR*=1 mode, but not with *FR*=0, and not on a 32-bit FPU.

Availability and Compatibility:

This instruction has been removed in Release 6.

Operation:

```
vAddr ← (GPR[base]+GPR[index])31..3 || 03
(pAddr, CCA) ← AddressTranslation(vAddr, DATA, LOAD)
pAddr ← pAddr xor ((BigEndianCPU xor ReverseEndian) || 02)
memlsw ← LoadMemory(CCA, WORD, pAddr, vAddr, DATA)
pAddr ← pAddr xor 0b100
memmsw ← LoadMemory(CCA, WORD, pAddr, vAddr+4, DATA)
memdoubleword ← memmsw || memlsw
StoreFPR(ft, UNINTERPRETED_DOUBLEWORD, memdoubleword)
```

Exceptions:

Coprocessor Unusable, Reserved Instruction, TLB Refill, TLB Invalid, Watch

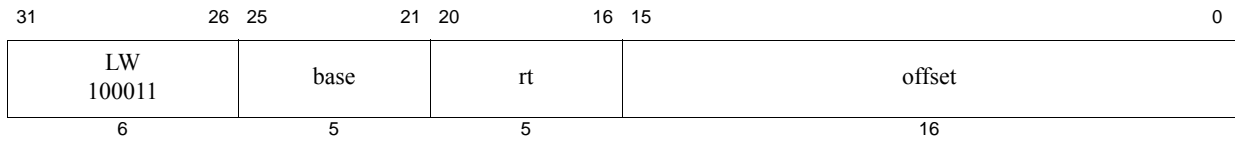

Format: LW *rt*, *offset*(*base*)

MIPS32

Purpose: Load Word

To load a word from memory as a signed value

Description: $GPR[rt] \leftarrow memory[GPR[base] + offset]$

The contents of the 32-bit word at the memory location specified by the aligned effective address are fetched, sign-extended to the GPR register length if necessary, and placed in GPR *rt*. The 16-bit signed *offset* is added to the contents of GPR *base* to form the effective address.

Restrictions:

Pre-Release 6: The effective address must be naturally-aligned. If either of the 2 least-significant bits of the address is non-zero, an Address Error exception occurs.

Release 6 allows hardware to provide address misalignment support in lieu of requiring natural alignment.

Note: The pseudocode is not completely adapted for Release 6 misalignment support as the handling is implementation dependent.

Operation:

```
vAddr ← sign_extend(offset) + GPR[base]
(pAddr, CCA) ← AddressTranslation(vAddr, DATA, LOAD)
memword ← LoadMemory(CCA, WORD, pAddr, vAddr, DATA)
GPR[rt] ← memword
```

Exceptions:

TLB Refill, TLB Invalid, Bus Error, Address Error, Watch

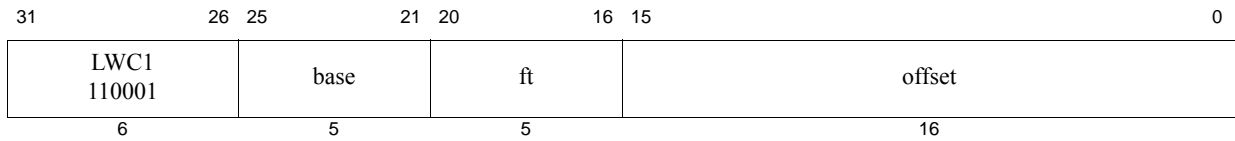

Format: LWC1 *ft*, *offset*(*base*)

MIPS32

Purpose: Load Word to Floating Point

To load a word from memory to an FPR

Description: $FPR[ft] \leftarrow \text{memory}[GPR[base] + \text{offset}]$

The contents of the 32-bit word at the memory location specified by the aligned effective address are fetched and placed into the low word of FPR *ft*. If FPRs are 64 bits wide, bits 63..32 of FPR *ft* become **UNPREDICTABLE**. The 16-bit signed *offset* is added to the contents of GPR *base* to form the effective address.

Restrictions:

Pre-Release 6: An Address Error exception occurs if $\text{EffectiveAddress}_{1..0} \neq 0$ (not word-aligned).

Release 6 allows hardware to provide address misalignment support in lieu of requiring natural alignment.

Note: The pseudocode is not completely adapted for Release 6 misalignment support as the handling is implementation dependent.

Operation:

```
vAddr ← sign_extend(offset) + GPR[base]
(pAddr, CCA) ← AddressTranslation(vAddr, DATA, LOAD)
memword ← LoadMemory(CCA, WORD, pAddr, vAddr, DATA)
StoreFPR(ft, UNINTERPRETED_WORD, memword)
```

Exceptions:

TLB Refill, TLB Invalid, Address Error, Reserved Instruction, Coprocessor Unusable, Watch

pre-Release 6

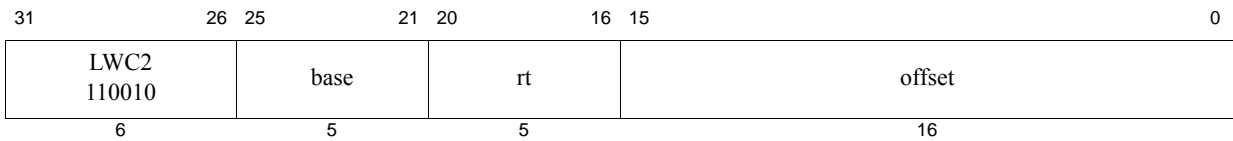

Release 6

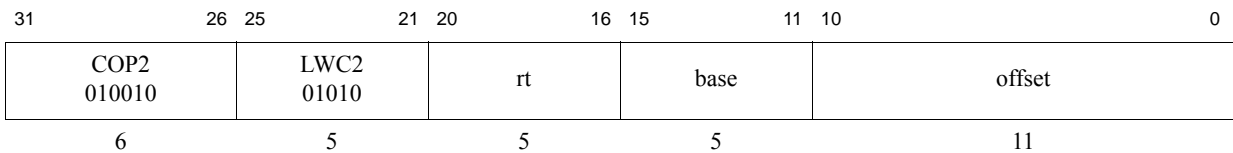
**Format:** LWC2 *rt*, *offset*(*base*)**MIPS32****Purpose:** Load Word to Coprocessor 2

To load a word from memory to a COP2 register.

Description: $CPR[2,rt,0] \leftarrow \text{memory}[GPR[base] + \text{offset}]$

The contents of the 32-bit word at the memory location specified by the aligned effective address are fetched and placed into the low word of *COP2* (Coprocessor 2) general register *rt*. The signed *offset* is added to the contents of GPR *base* to form the effective address.

Restrictions:Pre-Release 6: An Address Error exception occurs if $\text{+EffectiveAddress}_{1..0} \neq 0$ (not word-aligned).

Release 6 allows hardware to provide address misalignment support in lieu of requiring natural alignment.

Note: The pseudocode is not completely adapted for Release 6 misalignment support as the handling is implementation dependent.

Availability and Compatibility

This instruction has been recoded for Release 6.

Operation:

```

vAddr ← sign_extend(offset) + GPR[base]
(pAddr, CCA) ← AddressTranslation(vAddr, DATA, LOAD)
memword ← LoadMemory(CCA, DOUBLEWORD, pAddr, vAddr, DATA)
CPR[2,rt,0] ← memword

```

Exceptions:

TLB Refill, TLB Invalid, Address Error, Reserved Instruction, Coprocessor Unusable, Watch

Programming Notes:

Release 6 implements an 11-bit offset, whereas all release levels lower than Release 6 implement a 16-bit offset.

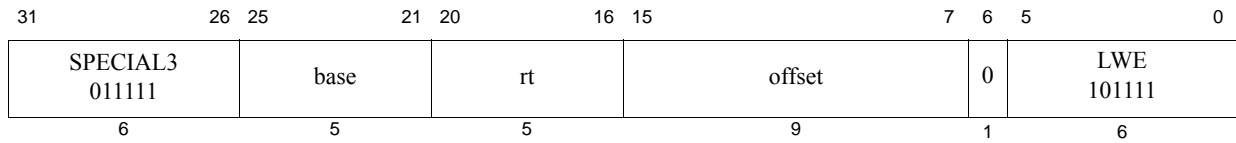

Format: LWE *rt*, *offset*(*base*)

MIPS32

Purpose: Load Word EVA

To load a word from user mode virtual address space when executing in kernel mode.

Description: $GPR[rt] \leftarrow \text{memory}[GPR[base] + \text{offset}]$

The contents of the 32-bit word at the memory location specified by the aligned effective address are fetched, sign-extended to the GPR register length if necessary, and placed in GPR *rt*. The 9-bit signed *offset* is added to the contents of GPR *base* to form the effective address.

The LWE instruction functions the same as the LW instruction, except that address translation is performed using the user mode virtual address space mapping in the TLB when accessing an address within a memory segment configured to use the MUSUK access mode. Memory segments using UUSK or MUSK access modes are also accessible. Refer to Volume III, Enhanced Virtual Addressing section for additional information.

Implementation of this instruction is specified by the *Config5_{EVA}* field being set to one.

Restrictions:

Only usable when access to Coprocessor0 is enabled and when accessing an address within a segment configured using UUSK, MUSK or MUSUK access mode.

Pre-Release 6: The effective address must be naturally-aligned. If either of the 2 least-significant bits of the address is non-zero, an Address Error exception occurs.

Release 6 allows hardware to provide address misalignment support in lieu of requiring natural alignment.

Note: The pseudocode is not completely adapted for Release 6 misalignment support as the handling is implementation dependent.

Operation:

```
vAddr ← sign_extend(offset) + GPR[base]
(pAddr, CCA) ← AddressTranslation(vAddr, DATA, LOAD)
memword ← LoadMemory(CCA, WORD, pAddr, vAddr, DATA)
GPR[rt] ← memword
```

Exceptions:

TLB Refill, TLB Invalid, Bus Error, Address Error, Watch, Reserved Instruction, Coprocessor Unusable

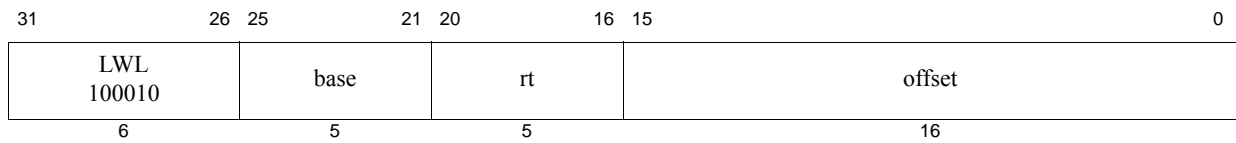

Format: LWL *rt*, *offset*(*base*)

MIPS32, removed in Release 6

Purpose: Load Word Left

To load the most-significant part of a word as a signed value from an unaligned memory address

Description: $GPR[rt] \leftarrow GPR[rt] \text{ MERGE } \text{memory}[GPR[base] + \text{offset}]$

The 16-bit signed *offset* is added to the contents of GPR *base* to form an effective address (*EffAddr*). *EffAddr* is the address of the most-significant of 4 consecutive bytes forming a word (*W*) in memory starting at an arbitrary byte boundary.

The most-significant 1 to 4 bytes of *W* is in the aligned word containing the *EffAddr*. This part of *W* is loaded into the most-significant (left) part of the word in GPR *rt*. The remaining least-significant part of the word in GPR *rt* is unchanged.

The figure below illustrates this operation using big-endian byte ordering for 32-bit and 64-bit registers. The 4 consecutive bytes in 2..5 form an unaligned word starting at location 2. A part of *W*, 2 bytes, is in the aligned word containing the most-significant byte at 2. First, LWL loads these 2 bytes into the left part of the destination register word and leaves the right part of the destination word unchanged. Next, the complementary LWR loads the remainder of the unaligned word

Figure 4.1 Unaligned Word Load Using LWL and LWR

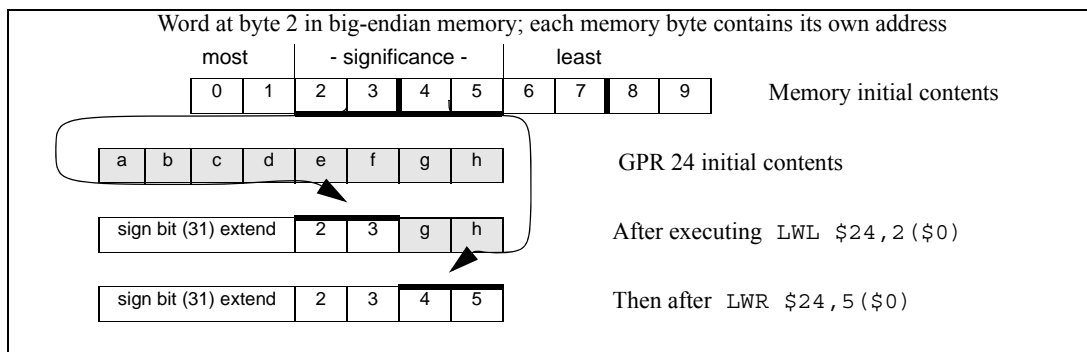

The bytes loaded from memory to the destination register depend on both the offset of the effective address within an aligned word, that is, the low 2 bits of the address ($vAddr_{1..0}$), and the current byte-ordering mode of the processor (big- or little-endian). The figure below shows the bytes loaded for every combination of offset and byte ordering.

Figure 4.2 Bytes Loaded by LWL Instruction

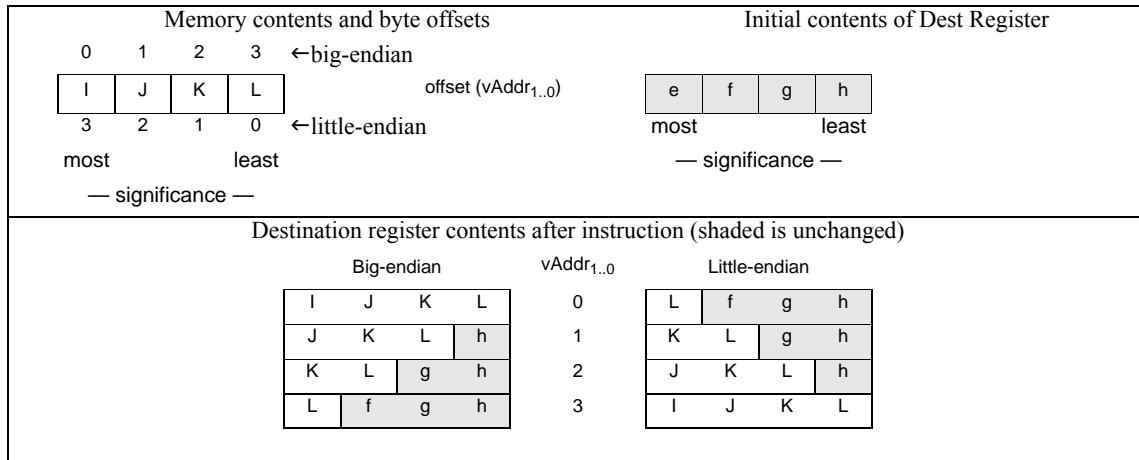
**Restrictions:**

None

Availability and Compatibility:

Release 6 removes the load/store-left/right family of instructions, and requires the system to support misaligned memory accesses.

Operation:

```

vAddr ← sign_extend(offset) + GPR[base]
(pAddr, CCA) ← AddressTranslation(vAddr, DATA, LOAD)
pAddr ← pAddrPSIZE-1..2 || (pAddr1..0 xor ReverseEndian2)
if BigEndianMem = 0 then
    pAddr ← pAddrPSIZE-1..2 || 02
endif
byte ← vAddr1..0 xor BigEndianCPU2
memword ← LoadMemory(CCA, byte, pAddr, vAddr, DATA)
temp ← memword7+8*byte..0 || GPR[rt]23-8*byte..0
GPR[rt] ← temp

```

Exceptions:

TLB Refill, TLB Invalid, Bus Error, Address Error, Watch

Programming Notes:

The architecture provides no direct support for treating unaligned words as unsigned values, that is, zeroing bits 63..32 of the destination register when bit 31 is loaded.

Historical Information:

In the MIPS I architecture, the LWL and LWR instructions were exceptions to the load-delay scheduling restriction. A LWL or LWR instruction which was immediately followed by another LWL or LWR instruction, and used the same destination register would correctly merge the 1 to 4 loaded bytes with the data loaded by the previous instruction. All such restrictions were removed from the architecture in MIPS II.

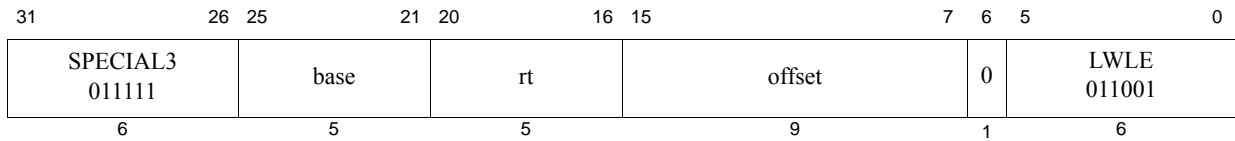

Format: LWLE rt, offset(base)

MIPS32, removed in Release 6

Purpose: Load Word Left EVA

To load the most-significant part of a word as a signed value from an unaligned user mode virtual address while executing in kernel mode.

Description: $GPR[rt] \leftarrow GPR[rt] \text{ MERGE } \text{memory}[GPR[base] + \text{offset}]$

The 9-bit signed *offset* is added to the contents of GPR *base* to form an effective address (*EffAddr*). *EffAddr* is the address of the most-significant of 4 consecutive bytes forming a word (*W*) in memory starting at an arbitrary byte boundary.

The most-significant 1 to 4 bytes of *W* is in the aligned word containing the *EffAddr*. This part of *W* is loaded into the most-significant (left) part of the word in GPR *rt*. The remaining least-significant part of the word in GPR *rt* is unchanged.

The figure below illustrates this operation using big-endian byte ordering for 32-bit and 64-bit registers. The 4 consecutive bytes in 2..5 form an unaligned word starting at location 2. A part of *W* (2 bytes) is in the aligned word containing the most-significant byte at 2.

1. LWLE loads these 2 bytes into the left part of the destination register word and leaves the right part of the destination word unchanged.
2. The complementary LWRE loads the remainder of the unaligned word.

Figure 4.3 Unaligned Word Load Using LWLE and LWRE

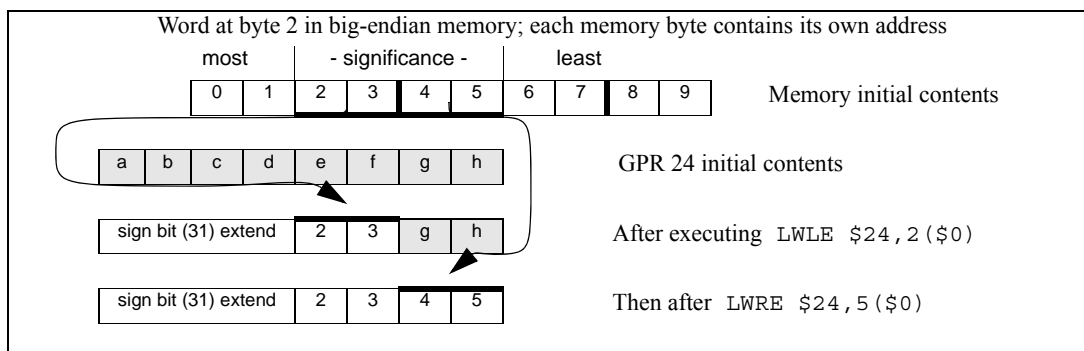

The bytes loaded from memory to the destination register depend on both the offset of the effective address within an aligned word, that is, the low 2 bits of the address ($vAddr_{1,0}$), and the current byte-ordering mode of the processor (big- or little-endian). The figure below shows the bytes loaded for every combination of offset and byte ordering.

The LWLE instruction functions the same as the LWL instruction, except that address translation is performed using the user mode virtual address space mapping in the TLB when accessing an address within a memory segment configured to use the MUSUK access mode. Memory segments using UUSK or MUSK access modes are also accessible. Refer to Volume III, Enhanced Virtual Addressing section for additional information.

Implementation of this instruction is specified by the $Config5_{EVA}$ field being set to 1.

Figure 4.4 Bytes Loaded by LWLE Instruction

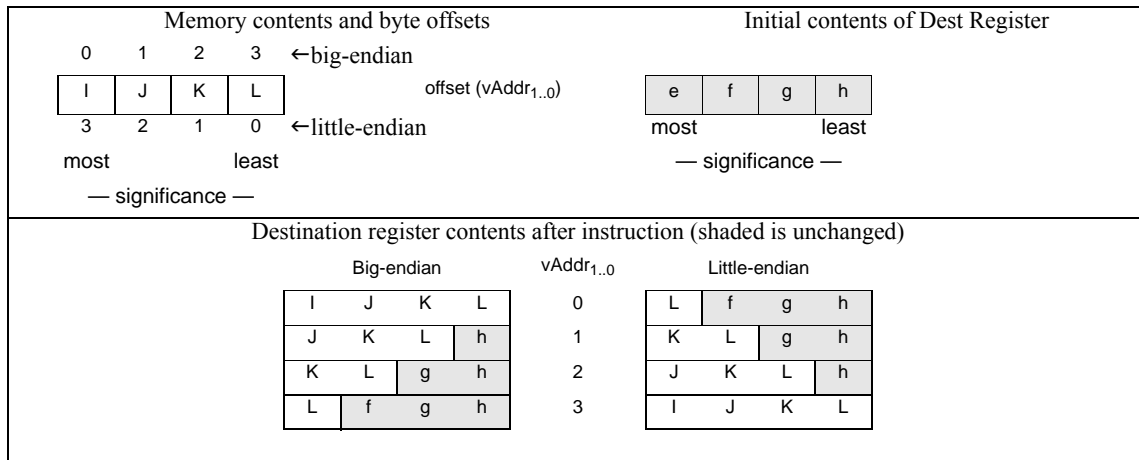

Restrictions:

Only usable when access to Coprocessor0 is enabled and when accessing an address within a segment configured using UUSK, MUSK or MUSUK access mode.

Availability and Compatibility:

Release 6 removes the load/store-left/right family of instructions, and requires the system to support misaligned memory accesses.

Operation:

```

vAddr ← sign_extend(offset) + GPR[base]
(pAddr, CCA) ← AddressTranslation(vAddr, DATA, LOAD)
pAddr ← pAddr_PSIZE-1..2 || (pAddr_1..0 xor ReverseEndian2)
if BigEndianMem = 0 then
    pAddr ← pAddr_PSIZE-1..2 || 02
endif
byte ← vAddr_1..0 xor BigEndianCPU2
memword ← LoadMemory(CCA, byte, pAddr, vAddr, DATA)
temp ← memword7+8*byte..0 || GPR[rt]23-8*byte..0
GPR[rt] ← temp
    
```

Exceptions:

TLB Refill, TLB Invalid, Bus Error, Address Error, Watch, Reserved Instruction, Coprocessor Unusable

Programming Notes:

The architecture provides no direct support for treating unaligned words as unsigned values, that is, zeroing bits 63..32 of the destination register when bit 31 is loaded.

Historical Information:

In the MIPS I architecture, the LWL and LWR instructions were exceptions to the load-delay scheduling restriction. A LWL or LWR instruction which was immediately followed by another LWL or LWR instruction, and used the

same destination register would correctly merge the 1 to 4 loaded bytes with the data loaded by the previous instruction. All such restrictions were removed from the architecture in MIPS II.

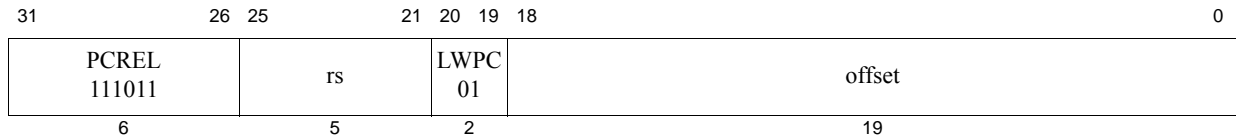

Format: LWPC *rs*, *offset*

MIPS32 Release 6

Purpose: Load Word PC-relative

To load a word from memory as a signed value, using a PC-relative address.

Description: $GPR[rs] \leftarrow \text{memory}[PC + \text{sign_extend}(\text{offset} \ll 2)]$

The offset is shifted left by 2 bits, sign-extended, and added to the address of the LWPC instruction.

The contents of the 32-bit word at the memory location specified by the aligned effective address are fetched, sign-extended to the GPR register length if necessary, and placed in GPR *rs*.

Restrictions:

LWPC is naturally aligned, by specification.

Availability and Compatibility:

This instruction is introduced by and required as of Release 6.

Operation

```
vAddr ← ( PC + sign_extend(offset) << 2 )
(pAddr, CCA) ← AddressTranslation (vAddr, DATA, LOAD)
memword ← LoadMemory (CCA, WORD, pAddr, vAddr, DATA)
GPR[rs] ← memword
```

Exceptions:

TLB Refill, TLB Invalid, TLB Read Inhibit, Bus Error, Address Error, Watch

Programming Note

The Release 6 PC-relative loads (LWPC) are considered data references.

For the purposes of watchpoints (provided by the CP0 *WatchHi* and *WatchLo* registers) and EJTAG breakpoints, the PC-relative reference is considered to be a data reference rather than an instruction reference. That is, the watchpoint or breakpoint is triggered only if enabled for data references.

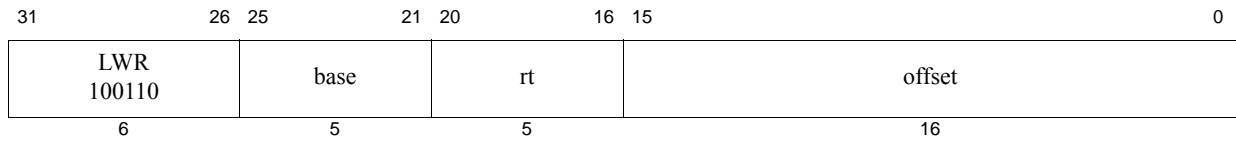

Format: LWR rt, offset(base)

MIPS32, removed in Release 6

Purpose: Load Word Right

To load the least-significant part of a word from an unaligned memory address as a signed value

Description: GPR[rt] ← GPR[rt] MERGE memory[GPR[base] + offset]

The 16-bit signed *offset* is added to the contents of GPR *base* to form an effective address (*EffAddr*). *EffAddr* is the address of the least-significant of 4 consecutive bytes forming a word (*W*) in memory starting at an arbitrary byte boundary.

A part of *W* (the least-significant 1 to 4 bytes) is in the aligned word containing *EffAddr*. This part of *W* is loaded into the least-significant (right) part of the word in GPR *rt*. The remaining most-significant part of the word in GPR *rt* is unchanged.

Executing both LWR and LWL, in either order, delivers a sign-extended word value in the destination register.

The figure below illustrates this operation using big-endian byte ordering for 32-bit and 64-bit registers. The 4 consecutive bytes in 2..5 form an unaligned word starting at location 2. A part of *W*, 2 bytes, is in the aligned word containing the least-significant byte at 5.

1. LWR loads these 2 bytes into the right part of the destination register.
2. The complementary LWL loads the remainder of the unaligned word.

Figure 4.5 Unaligned Word Load Using LWL and LWR

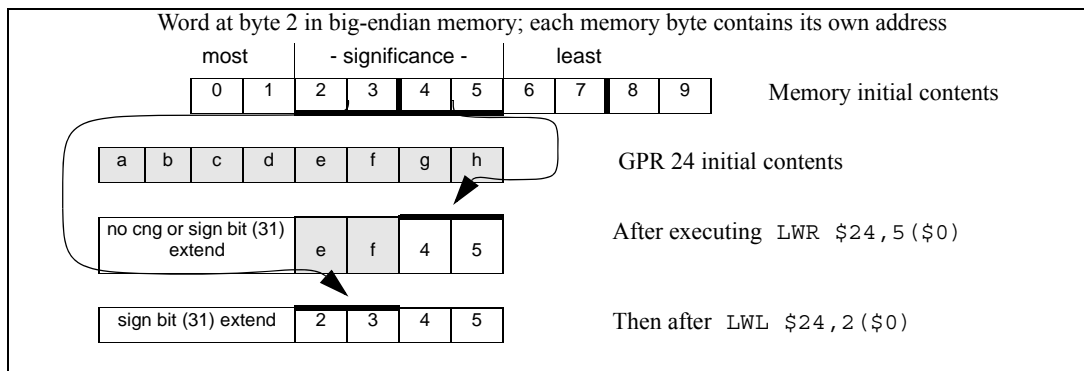

The bytes loaded from memory to the destination register depend on both the offset of the effective address within an aligned word, that is, the low 2 bits of the address ($vAddr_{1,0}$), and the current byte-ordering mode of the processor (big- or little-endian). The figure below shows the bytes loaded for every combination of offset and byte ordering.

Figure 4.6 Bytes Loaded by LWR Instruction

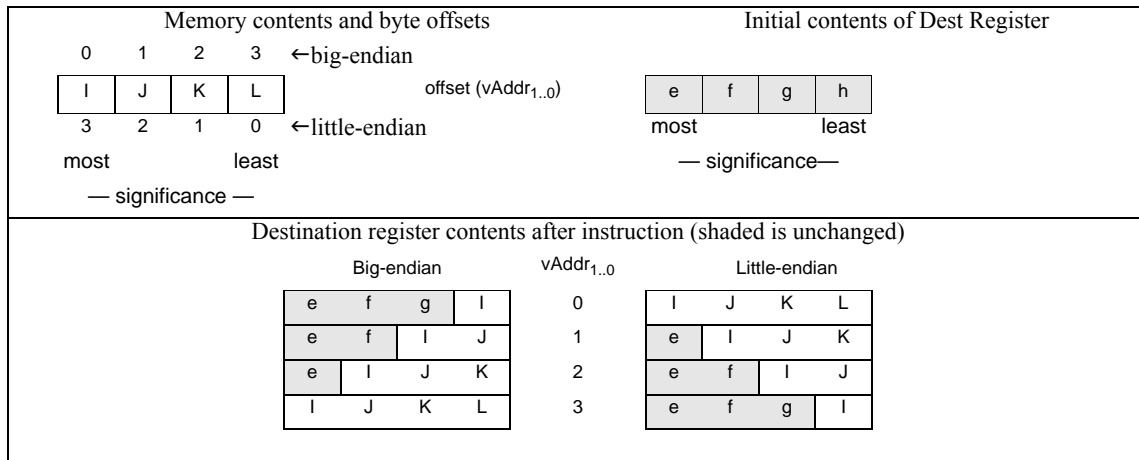
**Restrictions:**

None

Availability and Compatibility:

Release 6 removes the load/store-left/right family of instructions, and requires the system to support misaligned memory accesses.

Operation:

```

vAddr ← sign_extend(offset) + GPR[base]
(pAddr, CCA) ← AddressTranslation(vAddr, DATA, LOAD)
pAddr ← pAddrPSIZE-1..2 || (pAddr1..0 xor ReverseEndian2)
if BigEndianMem = 0 then
    pAddr ← pAddrPSIZE-1..2 || 02
endif
byte ← vAddr1..0 xor BigEndianCPU2
memword ← LoadMemory(CCA, byte, pAddr, vAddr, DATA)
temp ← memword31..32-8*byte || GPR[rt]31-8*byte..0
GPR[rt] ← temp

```

Exceptions:

TLB Refill, TLB Invalid, Bus Error, Address Error, Watch

Programming Notes:

The architecture provides no direct support for treating unaligned words as unsigned values, that is, zeroing bits 63..32 of the destination register when bit 31 is loaded.

Historical Information:

In the MIPS I architecture, the LWL and LWR instructions were exceptions to the load-delay scheduling restriction. A LWL or LWR instruction which was immediately followed by another LWL or LWR instruction, and used the same destination register would correctly merge the 1 to 4 loaded bytes with the data loaded by the previous instruction. All such restrictions were removed from the architecture in MIPS II.

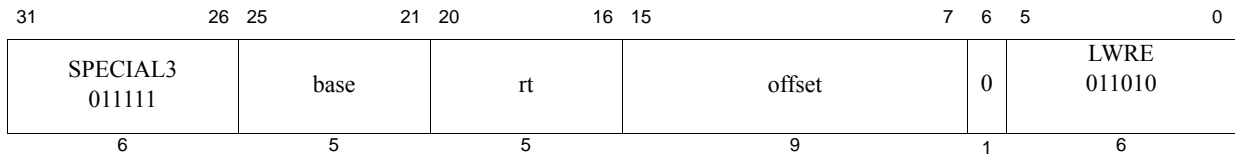

Format: LWRE *rt*, *offset*(*base*)

MIPS32, removed in Release 6

Purpose: Load Word Right EVA

To load the least-significant part of a word from an unaligned user mode virtual memory address as a signed value while executing in kernel mode.

Description: $GPR[rt] \leftarrow GPR[rt] \text{ MERGE } \text{memory}[GPR[base] + \text{offset}]$

The 9-bit signed *offset* is added to the contents of *GPR base* to form an effective address (*EffAddr*). *EffAddr* is the address of the least-significant of 4 consecutive bytes forming a word (*W*) in memory starting at an arbitrary byte boundary.

A part of *W* (the least-significant 1 to 4 bytes) is in the aligned word containing *EffAddr*. This part of *W* is loaded into the least-significant (right) part of the word in *GPR rt*. The remaining most-significant part of the word in *GPR rt* is unchanged.

Executing both LWRE and LWLE, in either order, delivers a sign-extended word value in the destination register.

The figure below illustrates this operation using big-endian byte ordering for 32-bit and 64-bit registers. The 4 consecutive bytes in 2..5 form an unaligned word starting at location 2. A part of *W* (2 bytes) is in the aligned word containing the least-significant byte at 5.

1. LWRE loads these 2 bytes into the right part of the destination register.
2. The complementary LWLE loads the remainder of the unaligned word.

The LWRE instruction functions in exactly the same fashion as the LWR instruction, except that address translation is performed using the user mode virtual address space mapping in the TLB when accessing an address within a memory segment configured to use the MUSUK access mode. Memory segments using UUSK or MUSK access modes are also accessible. Refer to Volume III, Enhanced Virtual Addressing section for additional information.

Implementation of this instruction is specified by the *Config5_{EVA}* field being set to one.

Figure 4.7 Unaligned Word Load Using LWLE and LWRE

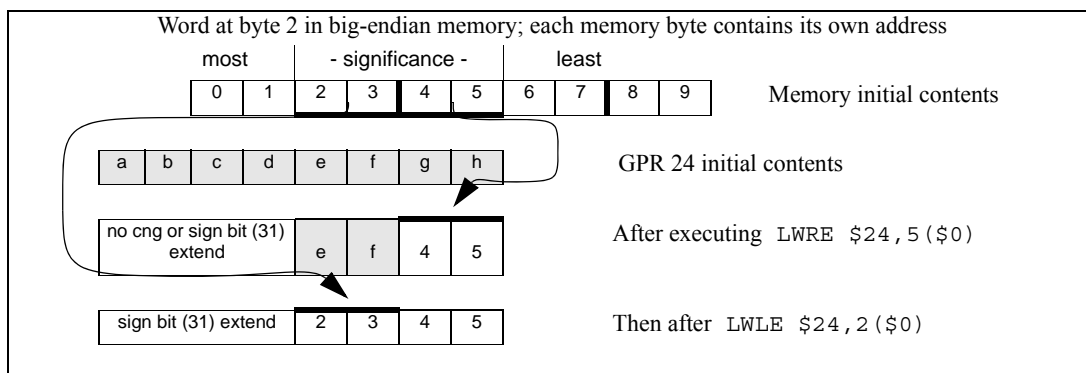

The bytes loaded from memory to the destination register depend on both the offset of the effective address within an aligned word, that is, the low 2 bits of the address ($vAddr_{1..0}$), and the current byte-ordering mode of the processor (big- or little-endian). The figure below shows the bytes loaded for every combination of offset and byte ordering.

Figure 4.8 Bytes Loaded by LWRE Instruction

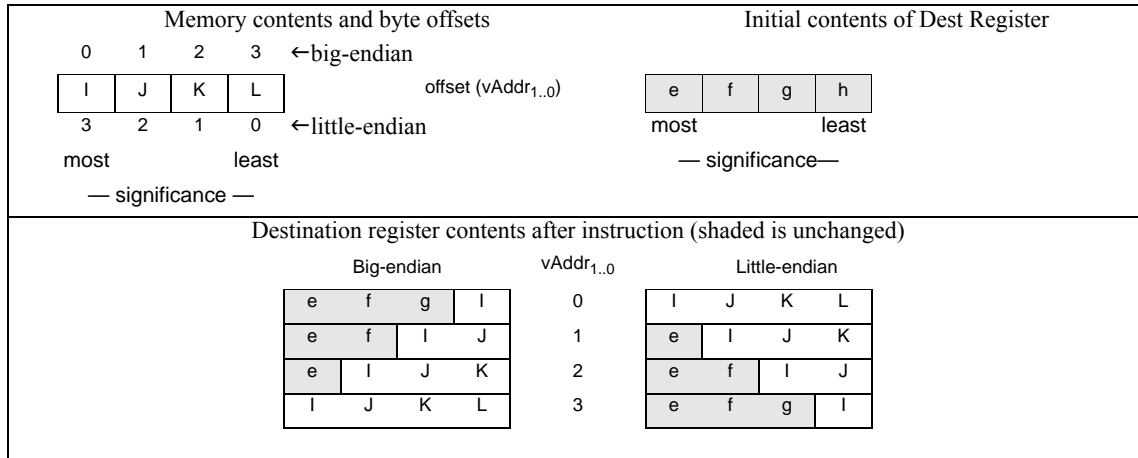

Restrictions:

Only usable when access to Coprocessor0 is enabled and when accessing an address within a segment configured using UUSK, MUSK or MUSUK access mode.

Availability and Compatibility:

Release 6 removes the load/store-left/right family of instructions, and requires the system to support misaligned memory accesses.

Operation:

```

vAddr ← sign_extend(offset) + GPR[base]
(pAddr, CCA) ← AddressTranslation(vAddr, DATA, LOAD)
pAddr ← pAddr_PSIZE-1..2 || (pAddr_1..0 xor ReverseEndian2)
if BigEndianMem = 0 then
    pAddr ← pAddr_PSIZE-1..2 || 02
endif
byte ← vAddr_1..0 xor BigEndianCPU2
memword ← LoadMemory(CCA, byte, pAddr, vAddr, DATA)
temp ← memword31..32-8*byte || GPR[rt]31-8*byte..0
GPR[rt] ← temp
    
```

Exceptions:

TLB Refill, TLB Invalid, Bus Error, Address Error, Watch, Reserved Instruction, Coprocessor Unusable

Programming Notes:

The architecture provides no direct support for treating unaligned words as unsigned values, that is, zeroing bits 63..32 of the destination register when bit 31 is loaded.

Historical Information:

In the MIPS I architecture, the LWL and LWR instructions were exceptions to the load-delay scheduling restriction. A LWL or LWR instruction which was immediately followed by another LWL or LWR instruction, and used the same destination register would correctly merge the 1 to 4 loaded bytes with the data loaded by the previous instruction. All such restrictions were removed from the architecture in MIPS II.

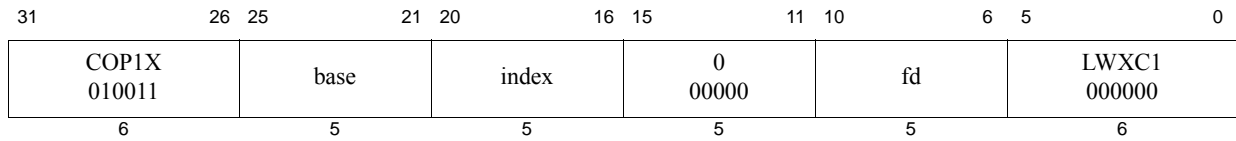

Format: LWXC1 *fd*, *index*(*base*)

MIPS32 Release 2, removed in Release 6

Purpose: Load Word Indexed to Floating Point

To load a word from memory to an FPR (GPR+GPR addressing).

Description: $FPR[fd] \leftarrow memory[GPR[base] + GPR[index]]$

The contents of the 32-bit word at the memory location specified by the aligned effective address are fetched and placed into the low word of FPR *fd*. If FPRs are 64 bits wide, bits 63..32 of FPR *fs* become **UNPREDICTABLE**. The contents of GPR *index* and GPR *base* are added to form the effective address.

Restrictions:

An Address Error exception occurs if $EffectiveAddress_{1..0} \neq 0$ (not word-aligned).

Availability and Compatibility:

This instruction has been removed in Release 6.

Required in all versions of MIPS64 since MIPS64 Release 1. Not available in MIPS32 Release 1. Required in MIPS32 Release 2 and all subsequent versions of MIPS32. When required, required whenever FPU is present, whether a 32-bit or 64-bit FPU, whether in 32-bit or 64-bit FP Register Mode ($FIR_{F64}=0$ or 1, $Status_{FR}=0$ or 1).

Operation:

```

vAddr ← GPR[base] + GPR[index]
if vAddr1..0 ≠ 02 then
    SignalException(AddressError)
endif
(pAddr, CCA) ← AddressTranslation (vAddr, DATA, LOAD)

memword ← LoadMemory(CCA, WORD, pAddr, vAddr, DATA)

StoreFPR(fd, UNINTERPRETED_WORD,
          memword)

```

Exceptions:

TLB Refill, TLB Invalid, Address Error, Reserved Instruction, Coprocessor Unusable, Watch

31	26 25	21 20	16 15	11 10	6 5	0
SPECIAL2 011100	rs	rt	0 0000	0 00000	MADD 000000	
6	5	5	5	5	6	

Format: MADD *rs*, *rt*

MIPS32, removed in Release 6

Purpose: Multiply and Add Word to Hi, Lo

To multiply two words and add the result to Hi, Lo.

Description: $(HI, LO) \leftarrow (HI, LO) + (GPR[rs] \times GPR[rt])$

The 32-bit word value in GPR *rs* is multiplied by the 32-bit word value in GPR *rt*, treating both operands as signed values, to produce a 64-bit result. The product is added to the 64-bit concatenated values of *HI* and *LO*. The most significant 32 bits of the result are written into *HI* and the least significant 32 bits are written into *LO*. No arithmetic exception occurs under any circumstances.

Restrictions:

This instruction does not provide the capability of writing directly to a target GPR.

Availability and Compatibility:

This instruction has been removed in Release 6.

Operation:

```
temp ← (HI || LO) + (GPR[rs] × GPR[rt])
HI ← temp63..32
LO ← temp31..0
```

Exceptions:

None

Programming Notes:

Where the size of the operands are known, software should place the shorter operand in GPR *rt*. This may reduce the latency of the instruction on those processors which implement data-dependent instruction latencies.

31	26 25	21 20	16 15	11 10	6 5	3 2	0
COP1X 010011	fr	ft	fs	fd	MADD 100	fmt	
6	5	5	5	5	3	3	

Format: MADD.fmt
MADD.S fd, fr, fs, ft
MADD.D fd, fr, fs, ft
MADD.PS fd, fr, fs, ft

MIPS32 Release 2, removed in Release 6
MIPS32 Release 2, removed in Release 6
MIPS32 Release 2, removed in Release 6

Purpose: Floating Point Multiply Add

To perform a combined multiply-then-add of FP values.

Description: $FPR[fd] \leftarrow (FPR[fs] \times FPR[ft]) + FPR[fr]$

The value in FPR *fs* is multiplied by the value in FPR *ft* to produce an intermediate product.

The intermediate product is rounded according to the current rounding mode in *FCSR*. The value in FPR *fr* is added to the product. The result sum is calculated to infinite precision, rounded according to the current rounding mode in *FCSR*, and placed into FPR *fd*. The operands and result are values in format *fmt*. The results and flags are as if separate floating-point multiply and add instructions were executed.

MADD.PS multiplies then adds the upper and lower halves of FPR *fr*, FPR *fs*, and FPR *ft* independently, and ORs together any generated exceptional conditions.

The *Cause* bits are ORed into the *Flag* bits if no exception is taken.

Restrictions:

The fields *fr*, *fs*, *ft*, and *fd* must specify FPRs valid for operands of type *fmt*. If the fields are not valid, the result is **UNPREDICTABLE**.

The operands must be values in format *fmt*; if they are not, the result is **UNPREDICTABLE** and the value of the operand FPRs becomes **UNPREDICTABLE**.

The result of MADD.PS is **UNPREDICTABLE** if the processor is executing in the *FR*=0 32-bit FPU register model. It is predictable if executing on a 64-bit FPU in the *FR*=1 mode, but not with *FR*=0, and not on a 32-bit FPU.

Availability and Compatibility:

MADD.S and MADD.D: Required in all versions of MIPS64 since MIPS64 Release 1. Not available in MIPS32 Release 1. Required in MIPS32 Release 2 and all subsequent versions of MIPS32. When required, these instructions are to be implemented if an FPU is present either in a 32-bit or 64-bit FPU or in a 32-bit or 64-bit FP Register Mode (*FIR*_{F64}=0 or 1, *Status*_{FR}=0 or 1).

This instruction has been removed in Release 6 and has been replaced by the fused multiply-add instruction. Refer to the fused multiply-add instruction ‘MADDF.fmt’ in this manual for more information. Release 6 does not support Paired Single (PS).

Operation:

```
vfr ← ValueFPR(fr, fmt)
vfs ← ValueFPR(fs, fmt)
vft ← ValueFPR(ft, fmt)
StoreFPR(fd, fmt, (vfs ×fmt vft) +fmt vfr)
```

Exceptions:

Coprocessor Unusable, Reserved Instruction

Floating Point Exceptions:

Inexact, Unimplemented Operation, Invalid Operation, Overflow, Underflow

31	26 25	21 20	16 15	11 10	6 5	0
COP1 010001	fmt	ft	fs	fd	MADDF 011000	
COP1 010001	fmt	ft	fs	fd	MSUBF 011001	
6	5	5	5	5	3	3

Format: MADDF.fmt MSUBF.fmt
MADDF.S fd, fs, ft
MADDF.D fd, fs, ft
MSUBF.S fd, fs, ft
MSUBF.D fd, fs, ft

MIPS32 Release 6
MIPS32 Release 6
MIPS32 Release 6
MIPS32 Release 6

Purpose: Floating Point Fused Multiply Add, Floating Point Fused Multiply Subtract

MADDF.fmt: To perform a fused multiply-add of FP values.

MSUBF.fmt: To perform a fused multiply-subtract of FP values.

Description:

MADDF.fmt: $FPR[fd] \leftarrow FPR[fd] + (FPR[fs] \times FPR[ft])$

MSUBF.fmt: $FPR[fd] \leftarrow FPR[fd] - (FPR[fs] \times FPR[ft])$

The value in FPR *fs* is multiplied by the value in FPR *ft* to produce an intermediate product. The intermediate product is calculated to infinite precision. The product is added to the value in FPR *fd*. The result sum is calculated to infinite precision, rounded according to the current rounding mode in *FCSR*, and placed into FPR *fd*. The operands and result are values in format *fmt*.

(For MSUBF.fmt, the product is subtracted from the value in FPR *fd*.)

Cause bits are ORed into the *Flag* bits if no exception is taken.

Restrictions:

None

Availability and Compatibility:

MADDF.fmt and MSUBF.fmt are required in Release 6.

MADDF.fmt and MSUBF.fmt are not available in architectures pre-Release 6.

The fused multiply add instructions, MADDF.fmt and MSUBF.fmt, replace pre-Release 6 instructions such as MADD.fmt, MSUB.fmt, NMADD.fmt, and NMSUB.fmt. The replaced instructions were unfused multiply-add, with an intermediate rounding.

Release 6 MSUBF.fmt, $fd \leftarrow fd - fs \times ft$, corresponds more closely to pre-Release 6 NMADD.fmt, $fd \leftarrow fr - fs \times ft$, than to pre-Release 6 MSUB.fmt, $fd \leftarrow fs \times ft - fr$.

FPU scalar MADDF.fmt corresponds to MSA vector MADD.df.

FPU scalar MSUBF.fmt corresponds to MSA vector MSUB.df.

Operation:

```
if not IsCoprocesorEnabled(1)
  then SignalException(CoprocesorUnusable, 1) endif
if not IsFloatingPointImplemented(fmt)
  then SignalException(ReservedInstruction) endif
```

```
vfr ← ValueFPR(fr, fmt)
vfs ← ValueFPR(fs, fmt)
vfd ← ValueFPR(fd, fmt)
MADDF.fmt: vinf ← vfd +∞ (vfs *∞ vft)
MADDF.fmt: vinf ← vfd -∞ (vfs *∞ vft)
StoreFPR(fd, fmt, vinf)
```

Special Considerations:

The fused multiply-add computation is performed in infinite precision, and signals Inexact, Overflow, or Underflow if and only if the final result differs from the infinite precision result in the appropriate manner.

Like most FPU computational instructions, if the flush-subnormals-to-zero mode, FCSR.FS=1, then subnormals are flushed before beginning the fused-multiply-add computation, and Inexact may be signaled.

I.e. Inexact may be signaled both by input flushing and/or by the fused-multiply-add: the conditions or ORed.

Exceptions:

Coprocessor Unusable, Reserved Instruction

Floating Point Exceptions:

Inexact, Unimplemented Operation, Invalid Operation, Overflow, Underflow

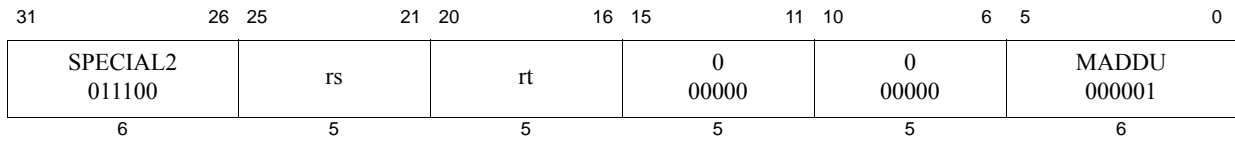

Format: MADDU *rs*, *rt*

MIPS32, removed in Release 6

Purpose: Multiply and Add Unsigned Word to Hi,Lo

To multiply two unsigned words and add the result to *HI*, *LO*.

Description: $(HI, LO) \leftarrow (HI, LO) + (GPR[rs] \times GPR[rt])$

The 32-bit word value in GPR *rs* is multiplied by the 32-bit word value in GPR *rt*, treating both operands as unsigned values, to produce a 64-bit result. The product is added to the 64-bit concatenated values of *HI* and *LO*. The most significant 32 bits of the result are written into *HI* and the least significant 32 bits are written into *LO*. No arithmetic exception occurs under any circumstances.

Restrictions:

None

This instruction does not provide the capability of writing directly to a target GPR.

Availability and Compatibility:

This instruction has been removed in Release 6.

Operation:

```
temp ← (HI || LO) + (GPR[rs] × GPR[rt])
HI ← temp63..32
LO ← temp31..0
```

Exceptions:

None

Programming Notes:

Where the size of the operands are known, software should place the shorter operand in GPR *rt*. This may reduce the latency of the instruction on those processors which implement data-dependent instruction latencies.

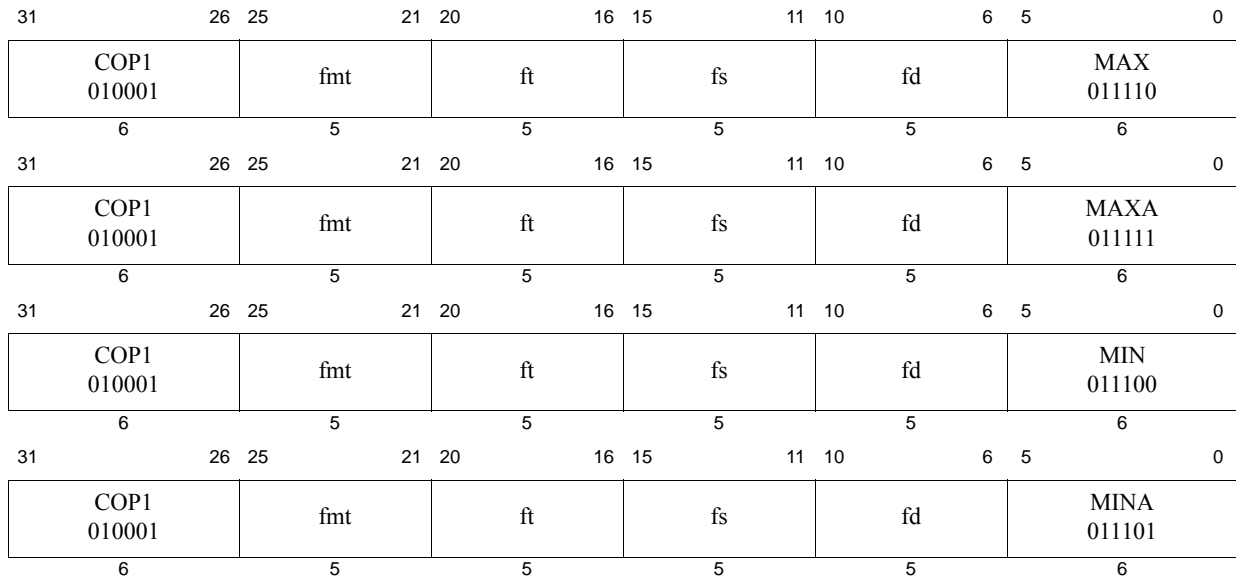

Format: MAX.fmt MIN.fmt MAXA.fmt MINA.fmt

MAX.S fd, fs, ft

MAX.D fd, fs, ft

MAXA.S fd, fs, ft

MAXA.D fd, fs, ft

MIN.S fd, fs, ft

MIN.D fd, fs, ft

MINA.S fd, fs, ft

MINA.D fd, fs, ft

MIPS32 Release 6

MIPS32 Release 6

MIPS32 Release 6

MIPS32 Release 6

MIPS32 Release 6

MIPS32 Release 6

MIPS32 Release 6

MIPS32 Release 6

Purpose: Scalar Floating-Point Max/Min/maxNumMag/minNumMag

Scalar Floating-Point Maximum

Scalar Floating-Point Minimum

Scalar Floating-Point argument with Maximum Absolute Value

Scalar Floating-Point argument with Minimum Absolute Value

Description:

MAX.fmt: $FPR[fd] \leftarrow \maxNum(FPR[fs], FPR[ft])$

MIN.fmt: $FPR[fd] \leftarrow \minNum(FPR[fs], FPR[ft])$

MAXA.fmt: $FPR[fd] \leftarrow \maxNumMag(FPR[fs], FPR[ft])$

MINA.fmt: $FPR[fd] \leftarrow \minNumMag(FPR[fs], FPR[ft])$

MAX.fmt writes the maximum value of the inputs fs and ft to the destination fd.

MIN.fmt writes the minimum value of the inputs fs and ft to the destination fd.

MAXA.fmt takes input arguments fs and ft and writes the argument with the maximum absolute value to the destination fd.

MINA.fmt takes input arguments fs and ft and writes the argument with the minimum absolute value to the destination fd.

The instructions MAX.fmt/MIN.fmt/MAXA.fmt/MINA.fmt correspond to the IEEE 754-2008 operations maxNum/

minNum/maxNumMag/minNumMag.

- MAX.fmt corresponds to the IEEE 754-2008 operation maxNum.
- MIN.fmt corresponds to the IEEE 754-2008 operation minNum.
- MAXA.fmt corresponds to the IEEE 754-2008 operation maxNumMag.
- MINA.fmt corresponds to the IEEE 754-2008 operation minNumMag.

Numbers are preferred to NaNs: if one input is a NaN, but not both, the value of the numeric input is returned. If both are NaNs, the NaN in `fs` is returned.¹

The scalar FPU instructions MAX.fmt/MIN.fmt/MAXA.fmt/MINA.fmt correspond to the MSA instructions FMAX.df/FMIN.df/FMAXA.df/FMINA.df.

- Scalar FPU instruction MAX.fmt corresponds to the MSA vector instruction FMAX.df.
- Scalar FPU instruction MIN.fmt corresponds to the MSA vector instruction FMIN.df.
- Scalar FPU instruction MAXA.fmt corresponds to the MSA vector instruction FMAX_A.df.
- Scalar FPU instruction MINA.fmt corresponds to the MSA vector instruction FMIN_A.df.

Restrictions:

Data-dependent exceptions are possible as specified by the IEEE Standard for Floating-Point Arithmetic 754TM-2008. See also the section “Special Cases”, below.

Availability and Compatibility:

These instructions are introduced by and required as of Release 6.

Operation:

```

if not IsCoprocesorEnabled(1)
  then SignalException(CoprocesorUnusable, 1) endif
if not IsFloatingPointImplemented(fmt)
  then SignalException(ReservedInstruction) endif

v1 ← ValueFPR(fs, fmt)
v2 ← ValueFPR(ft, fmt)

if SNaN(v1) or SNaN(v2) then
  then SignalException(InvalidOperand) endif

if NaN(v1) and NaN(v2) then
  ftmp ← v1
elseif NaN(v1) then
  ftmp ← v2
elseif NaN(v2) then
  ftmp ← v1
else
  case instruction of

```

1. IEEE standard 754-2008 allows either input to be chosen if both inputs are NaNs. Release 6 specifies that the first input must be propagated.

```

FMAX.fmt:  ftmp ← MaxFP.fmt (ValueFPR(fs,fmt),ValueFPR(ft,fmt))
FMIN.fmt:  ftmp ← MinFP.fmt (ValueFPR(fs,fmt),ValueFPR(ft,fmt))
FMAXA.fmt: ftmp ← MaxAbsoluteFP.fmt (ValueFPR(fs,fmt),ValueFPR(ft,fmt))
FMINA.fmt: ftmp ← MinAbsoluteFP.fmt (ValueFPR(fs,fmt),ValueFPR(ft,fmt))
end case
endif

StoreFPR (fd, fmt, ftmp)
/* end of instruction */

function MaxFP(tt, ts, n)
  /* Returns the largest argument. */
endfunction MaxFP

function MinFP(tt, ts, n)
  /* Returns the smallest argument. */
endfunction MinFP

function MaxAbsoluteFP(tt, ts, n)
  /* Returns the argument with largest absolute value.
   For equal absolute values, returns the largest argument.*/
endfunction MaxAbsoluteFP

function MinAbsoluteFP(tt, ts, n)
  /* Returns the argument with smallest absolute value.
   For equal absolute values, returns the smallest argument.*/
endfunction MinAbsoluteFP

function NaN(tt, ts, n)
  /* Returns true if the value is a NaN */
  return SNaN(value) or QNaN(value)
endfunction NaN

```

Table 4.1 Special Cases for FP MAX, MIN, MAXA, MINA

Operand		Other	Release 6 Instructions			
fs	ft		MAX	MIN	MAXA	MINA
-0.0	0.0		0.0	-0.0	0.0	-0.0
0.0	-0.0					
QNaN	#		#	#	#	#
#	QNaN					
QNaN1	QNaN2	Release 6	QNaN1	QNaN1	QNaN1	QNaN1
		IEEE 754 2008	Arbitrary choice. Not allowed to clear sign bit.			

Table 4.1 Special Cases for FP MAX, MIN, MAXA, MINA

Operand		Other	Release 6 Instructions			
fs	ft		MAX	MIN	MAXA	MINA
Either or both operands SNaN		Invalid Operation exception enabled	Signal Invalid Operation Exception. Destination not written.			
		... disabled	Treat as if the SNaN were a QNaN (do not quieten the result).			

Exceptions:

Coprocesor Unusable, Reserved Instruction

Floating Point Exceptions:

Unimplemented Operation, Invalid Operation

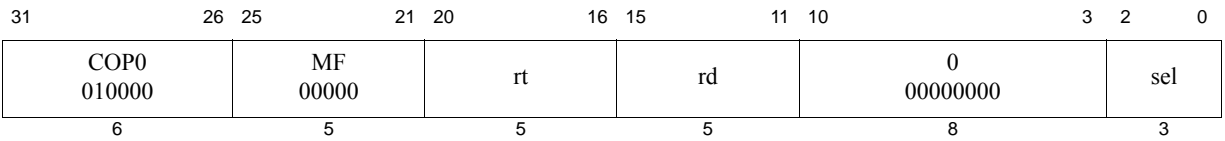

Format: MFC0 rt, rd
MFC0 rt, rd, sel

MIPS32
MIPS32

Purpose: Move from Coprocessor 0

To move the contents of a coprocessor 0 register to a general register.

Description: $GPR[rt] \leftarrow CPR[0,rd,sel]$

The contents of the coprocessor 0 register specified by the combination of *rd* and *sel* are loaded into general register *rt*. Not all coprocessor 0 registers support the *sel* field. In those instances, the *sel* field must be zero.

Restrictions:

Pre-Release 6: The results are **UNDEFINED** if coprocessor 0 does not contain a register as specified by *rd* and *sel*.

Release 6: Reading a reserved register or a register that is not implemented for the current core configuration returns 0.

Operation:

```

reg = rd
if IsCoproprocessorRegisterImplemented(0, reg, sel) then
    data ← CPR[0, reg, sel]
    GPR[rt] ← data
else
    if ArchitectureRevision() ≥ 6 then
        GPR[rt] ← 0
    else
        UNDEFINED
    endif
endif

```

Exceptions:

Coprocessor Unusable, Reserved Instruction

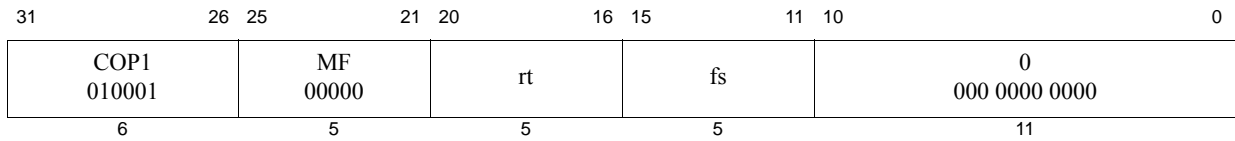

Format: MFC1 *rt*, *fs*

MIPS32

Purpose: Move Word From Floating Point

To copy a word from an FPU (CP1) general register to a GPR.

Description: $GPR[rt] \leftarrow FPR[fs]$

The contents of FPR *fs* are loaded into general register *rt*.

Restrictions:

Operation:

```
data ← ValueFPR(fs, UNINTERPRETED_WORD)
GPR[rt] ← data
```

Exceptions:

Coprocessor Unusable, Reserved Instruction

Historical Information:

For MIPS I, MIPS II, and MIPS III the contents of GPR *rt* are **UNPREDICTABLE** for the instruction immediately following MFC1.

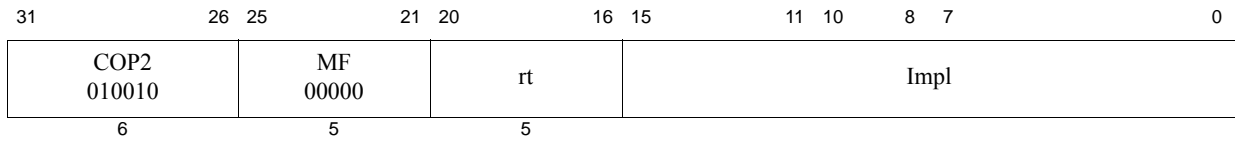

Format: MFC2 rt, Impl
MFC2, rt, Impl, sel

MIPS32
MIPS32

The syntax shown above is an example using MFC1 as a model. The specific syntax is implementation dependent.

Purpose: Move Word From Coprocessor 2

To copy a word from a COP2 general register to a GPR.

Description: $GPR[rt] \leftarrow CP2CPR[Impl]$

The contents of the coprocessor 2 register denoted by the *Impl* field are and placed into general register *rt*. The interpretation of the *Impl* field is left entirely to the Coprocessor 2 implementation and is not specified by the architecture.

Restrictions:

The results are **UNPREDICTABLE** if the *Impl* field specifies a coprocessor 2 register that does not exist.

Operation:

$data \leftarrow CP2CPR[Impl]$
 $GPR[rt] \leftarrow data$

Exceptions:

Coprocessor Unusable

31	26 25	21 20	16 15	11 10	3 2 0
COP0 010000	MFH 00010	rt	rd	0 00000000	sel
6	5	5	5	8	3

Format: MFHC0 rt, rd
MFHC0 rt, rd, sel

MIPS32 Release 5
MIPS32 Release 5

Purpose: Move from High Coprocessor 0

To move the contents of the upper 32 bits of a Coprocessor 0 register, extended by 32-bits, to a general register.

Description: $GPR[rt] \leftarrow CPR[0,rd,sel][63:32]$

The contents of the Coprocessor 0 register specified by the combination of *rd* and *sel* are loaded into general register *rt*. Not all Coprocessor 0 registers support the *sel* field, and in those instances, the *sel* field must be zero.

The MFHC0 operation is not affected when the Coprocessor 0 register specified is the *EntryLo0* or the *EntryLo1* register. Data is read from the upper half of the 32-bit register extended to 64-bits without modification before writing to the GPR. This is because RI and XI bits are not repositioned on write from GPR to *EntryLo0* or the *EntryLo1*.

Restrictions:

Pre-Release 6: The results are **UNDEFINED** if Coprocessor 0 does not contain a register as specified by *rd* and *sel*, or the register exists but is not extended by 32-bits, or the register is extended for XPA, but XPA is not supported or enabled.

Release 6: Reading the high part of a register that is reserved, not implemented for the current core configuration, or that is not extended beyond 32 bits returns 0.

Operation:

```

if Config5MVH = 0 then SignalException(ReservedInstruction) endif
reg ← rd
if IsCoprocessorRegisterImplemented(0, reg, sel) and
   IsCoprocessorRegisterExtended(0, reg, sel) then
  data ← CPR[0, reg, sel]
  GPR[rt] ← data63..32
else
  if ArchitectureRevision() ≥ 6 then
    GPR[rt] ← 0
  else
    UNDEFINED
  endif
endif
endif

```

Exceptions:

Coprocessor Unusable, Reserved Instruction

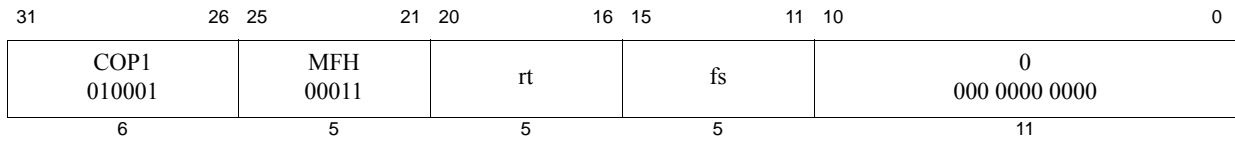

Format: MFHC1 *rt*, *fs*

MIPS32 Release 2

Purpose: Move Word From High Half of Floating Point Register

To copy a word from the high half of an FPU (CP1) general register to a GPR.

Description: $GPR[rt] \leftarrow FPR[fs]_{63..32}$

The contents of the high word of FPR *fs* are loaded into general register *rt*. This instruction is primarily intended to support 64-bit floating point units on a 32-bit CPU, but the semantics of the instruction are defined for all cases.

Restrictions:

In implementations prior to Release 2 of the architecture, this instruction resulted in a Reserved Instruction exception.

The results are **UNPREDICTABLE** if $Status_{FR} = 0$ and *fs* is odd.

Operation:

```
data ← ValueFPR(fs, UNINTERPRETED_DOUBLEWORD)_{63..32}
GPR[rt] ← data
```

Exceptions:

Coprocessor Unusable, Reserved Instruction

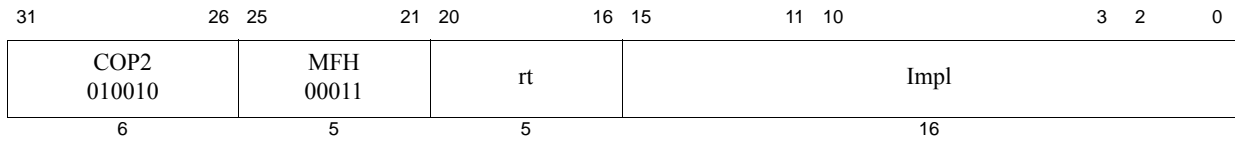

Format: MFHC2 *rt*, *Impl*
MFHC2, *rt*, *rd*, *sel*

MIPS32 Release 2
MIPS32 Release 2

The syntax shown above is an example using MFHC1 as a model. The specific syntax is implementation dependent.

Purpose: Move Word From High Half of Coprocessor 2 Register

To copy a word from the high half of a COP2 general register to a GPR.

Description: $GPR[rt] \leftarrow CP2CPR[Impl]_{63..32}$

The contents of the high word of the coprocessor 2 register denoted by the *Impl* field are placed into GPR *rt*. The interpretation of the *Impl* field is left entirely to the Coprocessor 2 implementation and is not specified by the architecture.

Restrictions:

The results are **UNPREDICTABLE** if the *Impl* field specifies a coprocessor 2 register that does not exist, or if that register is not 64 bits wide.

In implementations prior to Release 2 of the architecture, this instruction resulted in a Reserved Instruction exception.

Operation:

$data \leftarrow CP2CPR[Impl]_{63..32}$
 $GPR[rt] \leftarrow data$

Exceptions:

Coprocessor Unusable, Reserved Instruction

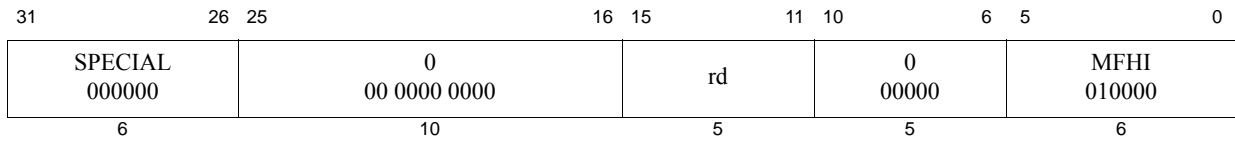

Format: MFHI rd

MIPS32, removed in Release 6

Purpose: Move From HI Register

To copy the special purpose *HI* register to a GPR.

Description: GPR[rd] ← HI

The contents of special register *HI* are loaded into GPR *rd*.

Restrictions:

None

Availability and Compatibility:

This instruction has been removed in Release 6.

Operation:

GPR[rd] ← HI

Exceptions:

None

Historical Information:

In the MIPS I, II, and III architectures, the two instructions which follow the MFHI must not modify the *HI* register. If this restriction is violated, the result of the MFHI is **UNPREDICTABLE**. This restriction was removed in MIPS IV and MIPS32, and all subsequent levels of the architecture.

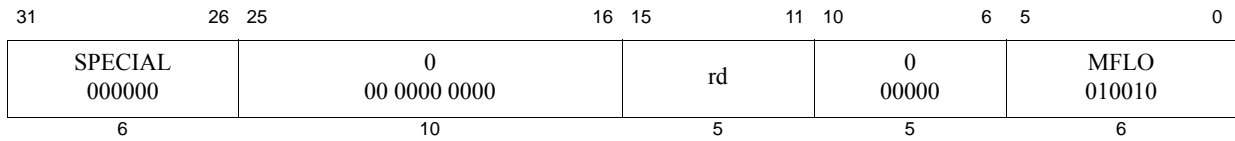

Format: MFLO rd

MIPS32, removed in Release 6

Purpose: Move From LO Register

To copy the special purpose *LO* register to a GPR.

Description: GPR[rd] ← LO

The contents of special register *LO* are loaded into GPR *rd*.

Restrictions:

None

Availability and Compatibility:

This instruction has been removed in Release 6.

Operation:

GPR[rd] ← LO

Exceptions:

None

Historical Information:

In the MIPS I, II, and III architectures, the two instructions which follow the MFLO must not modify the *HI* register. If this restriction is violated, the result of the MFLO is **UNPREDICTABLE**. This restriction was removed in MIPS IV and MIPS32, and all subsequent levels of the architecture.

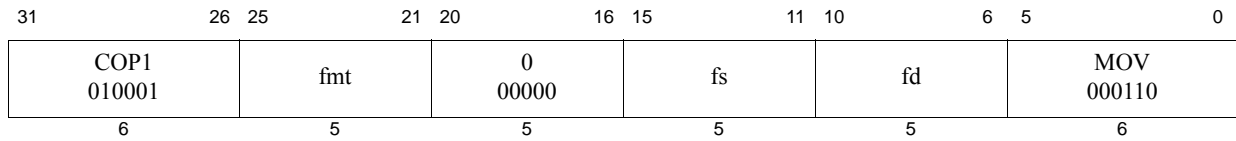

Format: MOV.fmt

MOV.S fd, fs

MOV.D fd, fs

MOV.PS fd, fs

MIPS32

MIPS32

MIPS64, MIPS32 Release 2, removed in Release 6

Purpose: Floating Point Move

To move an FP value between FPRs.

Description: $FPR[fd] \leftarrow FPR[fs]$

The value in FPR *fs* is placed into FPR *fd*. The source and destination are values in format *fmt*. In paired-single format, both the halves of the pair are copied to *fd*.

The move is non-arithmetic; it causes no IEEE 754 exceptions, and the $FCSR_{Cause}$ and $FCSR_{Flags}$ fields are not modified.

Restrictions:

The fields *fs* and *fd* must specify FPRs valid for operands of type *fmt*. If the fields are not valid, the result is **UNPREDICTABLE**.

The operand must be a value in format *fmt*; if it is not, the result is **UNPREDICTABLE** and the value of the operand FPR becomes **UNPREDICTABLE**.

The result of MOV.PS is **UNPREDICTABLE** if the processor is executing in the $FR=0$ 32-bit FPU register model. It is predictable if executing on a 64-bit FPU in the $FR=1$ mode, but not with $FR=0$, and not on a 32-bit FPU.

Availability and Compatibility:

MOV.PS has been removed in Release 6.

Operation:

```
StoreFPR(fd, fmt, ValueFPR(fs, fmt))
```

Exceptions:

Coprocessor Unusable, Reserved Instruction

Floating Point Exceptions:

Unimplemented Operation

31	26 25	21 20	18 17 16 15	11 10	6 5	0
SPECIAL 000000	rs	cc	0 0 tf 0 0	rd	0 00000	MOVCI 000001
6	5	3	1 1	5	5	6

Format: MOVF rd, rs, cc

MIPS32, removed in Release 6

Purpose: Move Conditional on Floating Point False

To test an FP condition code then conditionally move a GPR.

Description: if FPConditionCode(cc) = 0 then GPR[rd] ← GPR[rs]

If the floating point condition code specified by CC is zero, then the contents of GPR rs are placed into GPR rd.

Restrictions:

Availability and Compatibility:

This instruction has been removed in Release 6.

Operation:

```
if FPConditionCode(cc) = 0 then
    GPR[rd] ← GPR[rs]
endif
```

Exceptions:

Reserved Instruction, Coprocessor Unusable

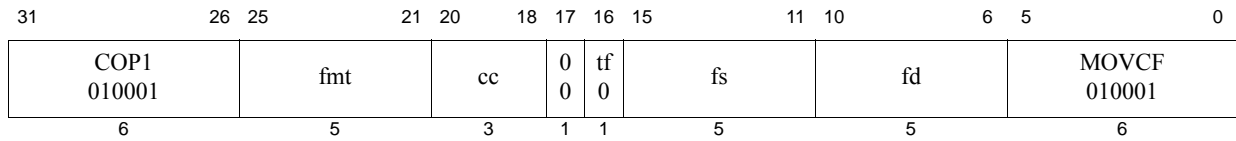

Format: MOV.F.fmt
 MOV.F.S fd, fs, cc
 MOV.F.D fd, fs, cc
 MOV.F.PS fd, fs, cc

MIPS32, removed in Release 6
MIPS32, removed in Release 6
removed in Release 6

Purpose: Floating Point Move Conditional on Floating Point False

To test an FP condition code then conditionally move an FP value.

Description: if FPConditionCode(cc) = 0 then FPR[fd] ← FPR[fs]

If the floating point condition code specified by *CC* is zero, then the value in FPR *fs* is placed into FPR *fd*. The source and destination are values in format *fmt*.

If the condition code is not zero, then FPR *fs* is not copied and FPR *fd* retains its previous value in format *fmt*. If *fd* did not contain a value either in format *fmt* or previously unused data from a load or move-to operation that could be interpreted in format *fmt*, then the value of *fd* becomes **UNPREDICTABLE**.

MOV.F.PS merges the lower half of FPR *fs* into the lower half of FPR *fd* if condition code *CC* is zero, and independently merges the upper half of FPR *fs* into the upper half of FPR *fd* if condition code *CC*+1 is zero. The *CC* field must be even; if it is odd, the result of this operation is **UNPREDICTABLE**.

The move is non-arithmetic; it causes no IEEE 754 exceptions, and the *FCSR*_{Cause} and *FCSR*_{Flags} fields are not modified.

Restrictions:

The fields *fs* and *fd* must specify FPRs valid for operands of type *fmt*. If the fields are not valid, the result is **UNPREDICTABLE**. The operand must be a value in format *fmt*. If it is not, the result is **UNPREDICTABLE** and the value of the operand FPR becomes **UNPREDICTABLE**.

The result of MOV.F.PS is **UNPREDICTABLE** if the processor is executing in the *FR*=0 32-bit FPU register model; it is predictable if executing on a 64-bit FPU in the *FR*=1 mode, but not with *FR*=0, and not on a 32-bit FPU.

Availability and Compatibility:

This instruction has been removed in Release 6 and has been replaced by the ‘SEL.fmt’ instruction. Refer to the SEL.fmt instruction in this manual for more information. Release 6 does not support Paired Single (PS).

Operation:

```
if FPConditionCode(cc) = 0 then
  StoreFPR(fd, fmt, ValueFPR(fs, fmt))
else
  StoreFPR(fd, fmt, ValueFPR(fd, fmt))
```

Exceptions:

Coprocessor Unusable, Reserved Instruction

Floating Point Exceptions:

Unimplemented Operation

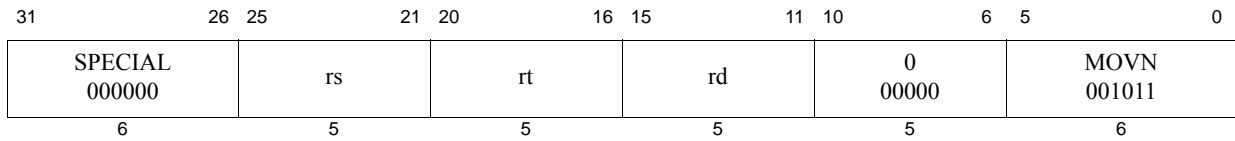

Format: MOVN rd, rs, rt

MIPS32, removed in Release 6

Purpose: Move Conditional on Not Zero

To conditionally move a GPR after testing a GPR value.

Description: if GPR[rt] \neq 0 then GPR[rd] \leftarrow GPR[rs]

If the value in GPR *rt* is not equal to zero, then the contents of GPR *rs* are placed into GPR *rd*.

Restrictions:

None

Availability and Compatibility:

This instruction has been removed in Release 6 and has been replaced by the ‘SELNEZ’ instruction. Refer to the SELNEZ instruction in this manual for more information.

Operation:

```
if GPR[rt]  $\neq$  0 then
    GPR[rd]  $\leftarrow$  GPR[rs]
endif
```

Exceptions:

None

Programming Notes:

The non-zero value tested might be the *condition true* result from the SLT, SLTI, SLTU, and SLTIU comparison instructions or a boolean value read from memory.

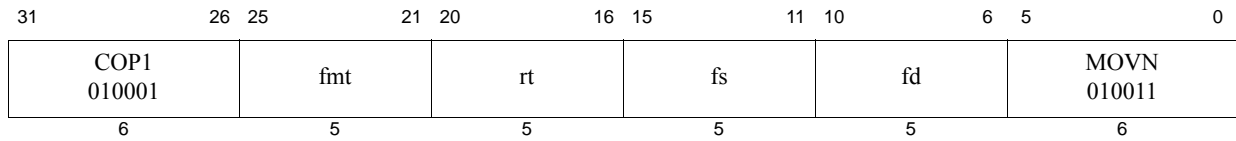

Format: MOVN.fmt
 MOVN.S fd, fs, rt
 MOVN.D fd, fs, rt
 MOVN.PS fd, fs, rt

MIPS32, removed in Release 6
MIPS32, removed in Release 6
MIPS32 Release 2, removed in Release 6

Purpose: Floating Point Move Conditional on Not Zero

To test a GPR then conditionally move an FP value.

Description: if $GPR[rt] \neq 0$ then $FPR[fd] \leftarrow FPR[fs]$

If the value in GPR *rt* is not equal to zero, then the value in FPR *fs* is placed in FPR *fd*. The source and destination are values in format *fmt*.

If GPR *rt* contains zero, then FPR *fs* is not copied and FPR *fd* contains its previous value in format *fmt*. If *fd* did not contain a value either in format *fmt* or previously unused data from a load or move-to operation that could be interpreted in format *fmt*, then the value of *fd* becomes **UNPREDICTABLE**.

The move is non-arithmetic; it causes no IEEE 754 exceptions, and the $FCSR_{Cause}$ and $FCSR_{Flags}$ fields are not modified.

Restrictions:

The fields *fs* and *fd* must specify FPRs valid for operands of type *fmt*. If the fields are not valid, the result is **UNPREDICTABLE**.

The operand must be a value in format *fmt*; if it is not, the result is **UNPREDICTABLE** and the value of the operand FPR becomes **UNPREDICTABLE**.

The result of MOVN.PS is **UNPREDICTABLE** if the processor is executing in the $FR=0$ 32-bit FPU register model. It is predictable if executing on a 64-bit FPU in the $FR=1$ mode, but not with $FR=0$, and not on a 32-bit FPU.

Availability and Compatibility:

This instruction has been removed in Release 6 and has been replaced by the ‘SELNEZ.fmt’ instruction. Refer to the SELNEZ.fmt instruction in this manual for more information. Release 6 does not support Paired Single (PS).

Operation:

```
if GPR[rt] ≠ 0 then
  StoreFPR(fd, fmt, ValueFPR(fs, fmt))
else
  StoreFPR(fd, fmt, ValueFPR(fd, fmt))
endif
```

Exceptions:

Coprocessor Unusable, Reserved Instruction

Floating Point Exceptions:

Unimplemented Operation

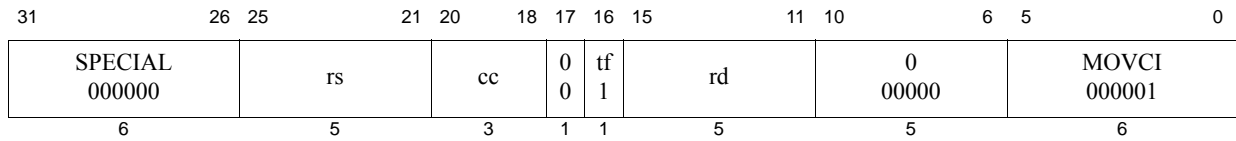

Format: MOV~~T~~ rd, rs, cc

MIPS32, removed in Release 6

Purpose: Move Conditional on Floating Point True

To test an FP condition code then conditionally move a GPR.

Description: if FPConditionCode(cc) = 1 then GPR[rd] ← GPR[rs]

If the floating point condition code specified by CC is one, then the contents of GPR rs are placed into GPR rd.

Restrictions:

Availability and Compatibility:

This instruction has been removed in Release 6.

Operation:

```
if FPConditionCode(cc) = 1 then
    GPR[rd] ← GPR[rs]
endif
```

Exceptions:

Reserved Instruction, Coprocessor Unusable

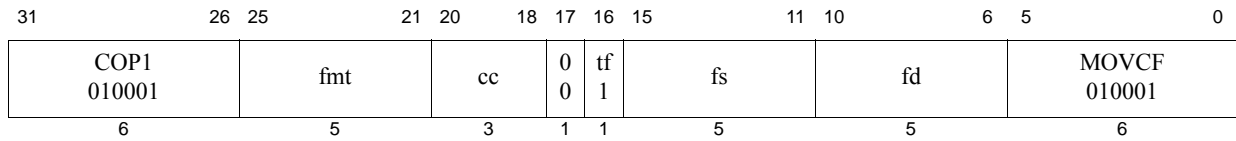

Format: MOV.T.fmt
 MOV.T.S fd, fs, cc
 MOV.T.D fd, fs, cc
 MOV.T.PS fd, fs, cc

MIPS32, removed in Release 6
MIPS32, removed in Release 6
MIPS32 Release 2, removed in Release 6

Purpose: Floating Point Move Conditional on Floating Point True

To test an FP condition code then conditionally move an FP value.

Description: if FPConditionCode(cc) = 1 then FPR[fd] ← FPR[fs]

If the floating point condition code specified by *CC* is one, then the value in FPR *fs* is placed into FPR *fd*. The source and destination are values in format *fmt*.

If the condition code is not one, then FPR *fs* is not copied and FPR *fd* contains its previous value in format *fmt*. If *fd* did not contain a value either in format *fmt* or previously unused data from a load or move-to operation that could be interpreted in format *fmt*, then the value of *fd* becomes **UNPREDICTABLE**.

MOV.T.PS merges the lower half of FPR *fs* into the lower half of FPR *fd* if condition code *CC* is one, and independently merges the upper half of FPR *fs* into the upper half of FPR *fd* if condition code *CC*+1 is one. The *CC* field should be even; if it is odd, the result of this operation is **UNPREDICTABLE**.

The move is non-arithmetic; it causes no IEEE 754 exceptions, and the *FCSR*_{Cause} and *FCSR*_{Flags} fields are not modified.

Restrictions:

The fields *fs* and *fd* must specify FPRs valid for operands of type *fmt*. If the fields are not valid, the result is **UNPREDICTABLE**. The operand must be a value in format *fmt*; if it is not, the result is **UNPREDICTABLE** and the value of the operand FPR becomes **UNPREDICTABLE**.

The result of MOV.T.PS is **UNPREDICTABLE** if the processor is executing in the *FR*=0 32-bit FPU register model. It is predictable if executing on a 64-bit FPU in the *FR*=1 mode, but not with *FR*=0, and not on a 32-bit FPU.

Availability and Compatibility

This instruction has been removed in Release 6 and has been replaced by the ‘SEL.fmt’ instruction. Refer to the SEL.fmt instruction in this manual for more information. Release 6 does not support Paired Single (PS).

Operation:

```
if FPConditionCode(cc) = 1 then
    StoreFPR(fd, fmt, ValueFPR(fs, fmt))
else
    StoreFPR(fd, fmt, ValueFPR(fd, fmt))
endif
```

Exceptions:

Coprocessor Unusable, Reserved Instruction

Floating Point Exceptions:

Unimplemented Operation

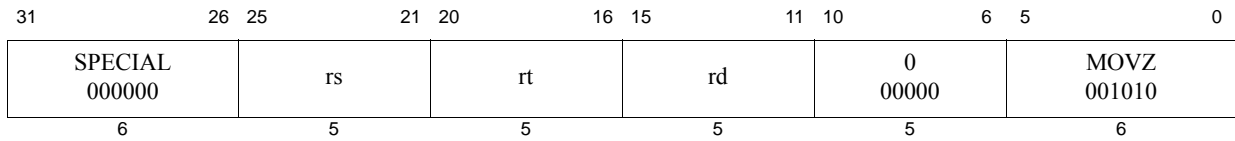

Format: MOVZ rd, rs, rt

MIPS32, removed in Release 6

Purpose: Move Conditional on Zero

To conditionally move a GPR after testing a GPR value.

Description: if GPR[rt] = 0 then GPR[rd] ← GPR[rs]

If the value in GPR *rt* is equal to zero, then the contents of GPR *rs* are placed into GPR *rd*.

Restrictions:

None

Availability and Compatibility:

This instruction has been removed in Release 6 and has been replaced by the ‘SELEQZ’ instruction. Refer to the SELEQZ instruction in this manual for more information.

Operation:

```
if GPR[rt] = 0 then
    GPR[rd] ← GPR[rs]
endif
```

Exceptions:

None

Programming Notes:

The zero value tested might be the *condition false* result from the SLT, SLTI, SLTU, and SLTIU comparison instructions or a boolean value read from memory.

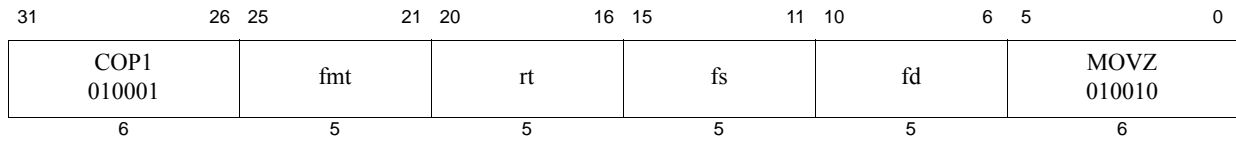

Format: MOVZ.fmt
 MOVZ.S fd, fs, rt
 MOVZ.D fd, fs, rt
 MOVZ.PS fd, fs, rt

MIPS32, removed in Release 6
MIPS32, removed in Release 6
MIPS32 Release 2, removed in Release 6

Purpose: Floating Point Move Conditional on Zero

To test a GPR then conditionally move an FP value.

Description: if $GPR[rt] = 0$ then $FPR[fd] \leftarrow FPR[fs]$

If the value in GPR *rt* is equal to zero then the value in FPR *fs* is placed in FPR *fd*. The source and destination are values in format *fmt*.

If GPR *rt* is not zero, then FPR *fs* is not copied and FPR *fd* contains its previous value in format *fmt*. If *fd* did not contain a value either in format *fmt* or previously unused data from a load or move-to operation that could be interpreted in format *fmt*, then the value of *fd* becomes **UNPREDICTABLE**.

The move is non-arithmetic; it causes no IEEE 754 exceptions, and the $FCSR_{Cause}$ and $FCSR_{Flags}$ fields are not modified.

Restrictions:

The fields *fs* and *fd* must specify FPRs valid for operands of type *fmt*. If the fields are not valid, the result is **UNPREDICTABLE**.

The operand must be a value in format *fmt*; if it is not, the result is **UNPREDICTABLE** and the value of the operand FPR becomes **UNPREDICTABLE**.

The result of MOVZ.PS is **UNPREDICTABLE** if the processor is executing in the $FR=0$ 32-bit FPU register model. It is predictable if executing on a 64-bit FPU in the $FR=1$ mode, but not with $FR=0$, and not on a 32-bit FPU.

Availability and Compatibility:

This instruction has been removed in Release 6 and has been replaced by the ‘SELEQZ.fmt’ instruction. Refer to the SELEQZ.fmt instruction in this manual for more information. Release 6 does not support Paired Single (PS).

Operation:

```
if GPR[rt] = 0 then
  StoreFPR(fd, fmt, ValueFPR(fs, fmt))
else
  StoreFPR(fd, fmt, ValueFPR(fd, fmt))
endif
```

Exceptions:

Coprocessor Unusable, Reserved Instruction

Floating Point Exceptions:

Unimplemented Operation

31	26 25	21 20	16 15	11 10	6 5	0
SPECIAL2 011100	rs	rt	0 00000	0 00000	MSUB 000100	
6	5	5	5	5	6	

Format: MSUB *rs*, *rt*

MIPS32, removed in Release 6

Purpose: Multiply and Subtract Word to Hi, Lo

To multiply two words and subtract the result from *HI*, *LO*.

Description: $(HI, LO) \leftarrow (HI, LO) - (GPR[rs] \times GPR[rt])$

The 32-bit word value in GPR *rs* is multiplied by the 32-bit value in GPR *rt*, treating both operands as signed values, to produce a 64-bit result. The product is subtracted from the 64-bit concatenated values of *HI* and *LO*. The most significant 32 bits of the result are written into *HI* and the least significant 32 bits are written into *LO*. No arithmetic exception occurs under any circumstances.

Restrictions:

No restrictions in any architecture releases except Release 6.

This instruction does not provide the capability of writing directly to a target GPR.

Availability and Compatibility:

This instruction has been removed in Release 6.

Operation:

```
temp ← (HI || LO) - (GPR[rs] × GPR[rt])
HI ← temp63..32
LO ← temp31..0
```

Exceptions:

None

Programming Notes:

Where the size of the operands are known, software should place the shorter operand in GPR *rt*. This may reduce the latency of the instruction on those processors which implement data-dependent instruction latencies.

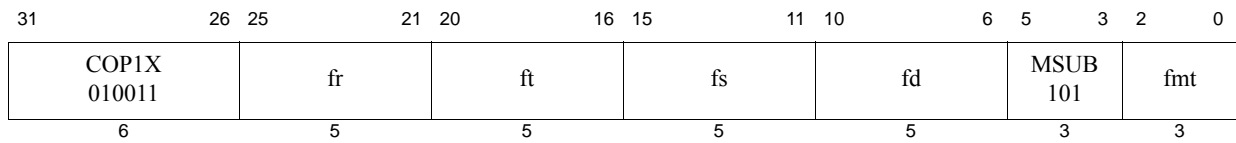

Format: MSUB.fmt
 MSUB.S fd, fr, fs, ft
 MSUB.D fd, fr, fs, ft
 MSUB.PS fd, fr, fs, ft

MIPS32 Release 2, removed in Release 6
MIPS32 Release 2, removed in Release 6
MIPS32 Release 2, removed in Release 6

Purpose: Floating Point Multiply Subtract

To perform a combined multiply-then-subtract of FP values.

Description: $FPR[fd] \leftarrow (FPR[fs] \times FPR[ft]) - FPR[fr]$

The value in FPR *fs* is multiplied by the value in FPR *ft* to produce an intermediate product. The intermediate product is rounded according to the current rounding mode in *FCSR*. The subtraction result is calculated to infinite precision, rounded according to the current rounding mode in *FCSR*, and placed into FPR *fd*. The operands and result are values in format *fmt*. The results and flags are as if separate floating-point multiply and subtract instructions were executed.

MSUB.PS multiplies then subtracts the upper and lower halves of FPR *fr*, FPR *fs*, and FPR *ft* independently, and ORs together any generated exceptional conditions.

The *Cause* bits are ORed into the *Flag* bits if no exception is taken.

Restrictions:

The fields *fr*, *fs*, *ft*, and *fd* must specify FPRs valid for operands of type *fmt*. If the fields are not valid, the result is **UNPREDICTABLE**.

The operands must be values in format *fmt*; if they are not, the result is **UNPREDICTABLE** and the value of the operand FPRs becomes **UNPREDICTABLE**.

The result of MSUB.PS is **UNPREDICTABLE** if the processor is executing in the *FR*=0 32-bit FPU register model. It is predictable if executing on a 64-bit FPU in the *FR*=1 mode, but not with *FR*=0, and not on a 32-bit FPU.

Availability and Compatibility:

MSUB.S and MSUB.D: Required in all versions of MIPS64 since MIPS64 Release 1. Not available in MIPS32 Release 1. Required in MIPS32 Release 2 and all subsequent versions of MIPS32. When required, these instructions are to be implemented if an FPU is present, either in a 32-bit or 64-bit FPU or in a 32-bit or 64-bit FP Register Mode (*FIR*₆₄=0 or 1, *Status*_{FR}=0 or 1).

This instruction has been removed in Release 6 and has been replaced by the fused multiply-subtract instruction. Refer to the fused multiply-subtract instruction ‘MSUBF.fmt’ in this manual for more information. Release 6 does not support Paired Single (PS).

Operation:

```
vfr ← ValueFPR(fr, fmt)
vfs ← ValueFPR(fs, fmt)
vft ← ValueFPR(ft, fmt)
StoreFPR(fd, fmt, (vfs ×fmt vft) -fmt vfr)
```

Exceptions:

Coprocessor Unusable, Reserved Instruction

Floating Point Exceptions:

Inexact, Unimplemented Operation, Invalid Operation, Overflow, Underflow

31	26 25	21 20	16 15	11 10	6 5	0
SPECIAL2 011100	rs	rt	0 00000	0 00000	MSUBU 000101	
6	5	5	5	5	6	

Format: MSUBU *rs*, *rt*

MIPS32, removed in Release 6

Purpose: Multiply and Subtract Word to Hi,Lo

To multiply two words and subtract the result from *HI*, *LO*.

Description: $(HI, LO) \leftarrow (HI, LO) - (GPR[rs] \times GPR[rt])$

The 32-bit word value in GPR *rs* is multiplied by the 32-bit word value in GPR *rt*, treating both operands as unsigned values, to produce a 64-bit result. The product is subtracted from the 64-bit concatenated values of *HI* and *LO*. The most significant 32 bits of the result are written into *HI* and the least significant 32 bits are written into *LO*. No arithmetic exception occurs under any circumstances.

Restrictions:

This instruction does not provide the capability of writing directly to a target GPR.

Availability and Compatibility:

This instruction has been removed in Release 6.

Operation:

```
temp ← (HI || LO) - (GPR[rs] × GPR[rt])
HI ← temp63..32
LO ← temp31..0
```

Exceptions:

None

Programming Notes:

Where the size of the operands are known, software should place the shorter operand in GPR *rt*. This may reduce the latency of the instruction on those processors which implement data-dependent instruction latencies.

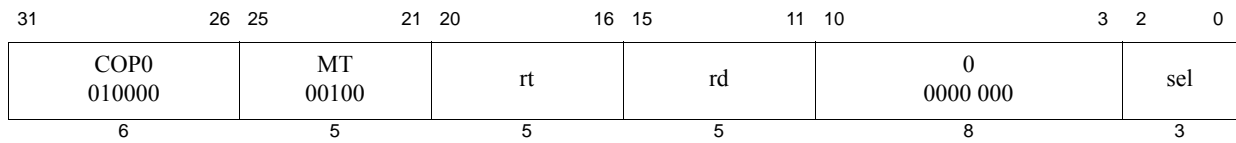

Format: MTC0 rt, rd
MTC0 rt, rd, sel

MIPS32
MIPS32

Purpose: Move to Coprocessor 0

To move the contents of a general register to a coprocessor 0 register.

Description: $CPR[0, rd, sel] \leftarrow GPR[rt]$

The contents of general register *rt* are loaded into the coprocessor 0 register specified by the combination of *rd* and *sel*. Not all coprocessor 0 registers support the *sel* field. In those instances, the *sel* field must be set to zero.

In Release 5, for a 32-bit processor, the MTC0 instruction writes all zeroes to the high-order bits of selected COP0 registers that have been extended beyond 32 bits. This is required for compatibility with legacy software that does not use MTHC0, yet has hardware support for extended COP0 registers (such as for Extended Physical Addressing (XPA)). Because MTC0 overwrites the result of MTHC0, software must first read the high-order bits before writing the low-order bits, then write the high-order bits back either modified or unmodified. For initialization of an extended register, software may first write the low-order bits, then the high-order bits, without first reading the high-order bits.

Restrictions:

Pre-Release 6: The results are **UNDEFINED** if coprocessor 0 does not contain a register as specified by *rd* and *sel*.

Release 6: Writes to a register that is reserved or not defined for the current core configuration are ignored.

Operation:

```

data ← GPR[rt]
reg ← rd
if IsCoprocessorRegisterImplemented (0, reg, sel) then
    CPR[0,reg,sel] ← data
    if (Config5MVH = 1) then
        // The most-significant bit may vary by register. Only supported
        // bits should be written 0. Extended LLAddr is not written with 0s,
        // as it is a read-only register. BadVAddr is not written with 0s, as
        // it is read-only
    if (Config3LPA = 1) then
        if (reg,sel = EntryLo0 or EntryLo1) then CPR[0,reg,sel]63:32 = 032
        endif
        if (reg,sel = MAAR) then CPR[0,reg,sel]63:32 = 032 endif
        // TagLo is zeroed only if the implementation-dependent bits
        // are writeable
        if (reg,sel = TagLo) then CPR[0,reg,sel]63:32 = 032 endif
    if (Config3VZ = 1) then
        if (reg,sel = EntryHi) then CPR[0,reg,sel]63:32 = 032 endif
    endif
endif
endif
else
    if ArchitectureRevision() ≥ 6 then
        // nop (no exceptions, coprocessor state not modified)
    else
        UNDEFINED
    endif
endif

```

```
    endif  
endif
```

Exceptions:

Coprocessor Unusable, Reserved Instruction

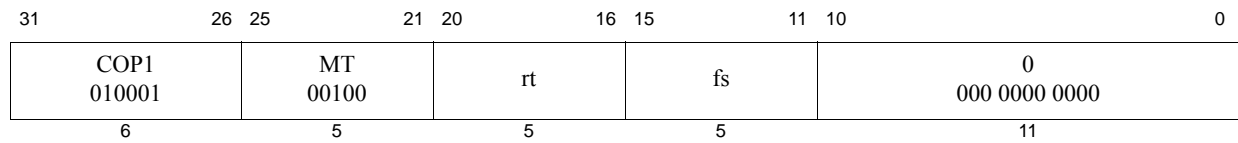

Format: MTC1 *rt*, *fs*

MIPS32

Purpose: Move Word to Floating Point

To copy a word from a GPR to an FPU (CP1) general register.

Description: $FPR[fs] \leftarrow GPR[rt]$

The low word in GPR *rt* is placed into the low word of FPR *fs*.

Restrictions:

Operation:

```
data ← GPR[rt]31..0
StoreFPR(fs, UNINTERPRETED_WORD, data)
```

Exceptions:

Coprocessor Unusable

Historical Information:

For MIPS I, MIPS II, and MIPS III the value of FPR *fs* is **UNPREDICTABLE** for the instruction immediately following MTC1.

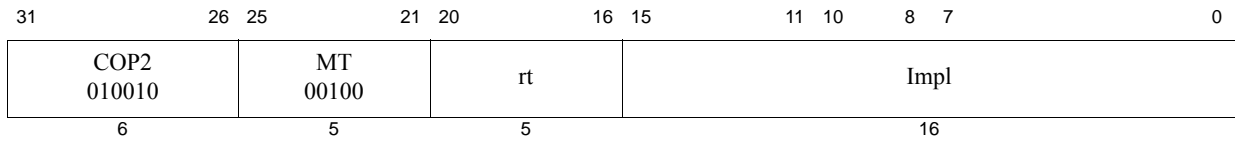

Format: MTC2 *rt*, *Impl*
MTC2 *rt*, *Impl*, *sel*

MIPS32
MIPS32

The syntax shown above is an example using MTC1 as a model. The specific syntax is implementation-dependent.

Purpose: Move Word to Coprocessor 2

To copy a word from a GPR to a COP2 general register.

Description: $CP2CPR[Impl] \leftarrow GPR[rt]$

The low word in GPR *rt* is placed into the low word of a Coprocessor 2 general register denoted by the *Impl* field. The interpretation of the *Impl* field is left entirely to the Coprocessor 2 implementation and is not specified by the architecture.

Restrictions:

The results are **UNPREDICTABLE** if the *Impl* field specifies a Coprocessor 2 register that does not exist.

Operation:

$data \leftarrow GPR[rt]$
 $CP2CPR[Impl] \leftarrow data$

Exceptions:

Coprocessor Unusable, Reserved Instruction

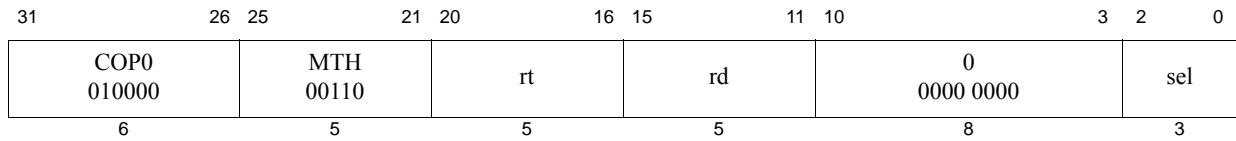

Format: MTHC0 *rt*, *rd*
MTHC0 *rt*, *rd*, *sel*

MIPS32 Release 5
MIPS32 Release 5

Purpose: Move to High Coprocessor 0

To copy a word from a GPR to the upper 32 bits of a COP2 general register that has been extended by 32 bits.

Description: $CPR[0, rd, sel][63:32] \leftarrow GPR[rt]$

The contents of general register *rt* are loaded into the Coprocessor 0 register specified by the combination of *rd* and *sel*. Not all Coprocessor 0 registers support the *sel* field; the *sel* field must be set to zero.

Restrictions:

Pre-Release 6: The results are **UNDEFINED** if Coprocessor 0 does not contain a register as specified by *rd* and *sel*, or if the register exists but is not extended by 32 bits, or the register is extended for XPA, but XPA is not supported or enabled.

Release 6: A write to the high part of a register that is reserved, not implemented for the current core, or that is not extended beyond 32 bits is ignored.

Operation:

```

if Config5MVH = 0 then SignalException(ReservedInstruction) endif
data ← GPR[rt]
reg ← rd
if IsCoprocessorRegisterImplemented (0, reg, sel) and
   IsCoprocessorRegisterExtended (0, reg, sel) then
    CPR[0, reg, sel][63:32] ← data
else
    if ArchitectureRevision() ≥ 6 then
        // nop (no exceptions, coprocessor state not modified)
    else
        UNDEFINED
    endif
endif

```

Exceptions:

Coprocessor Unusable, Reserved Instruction

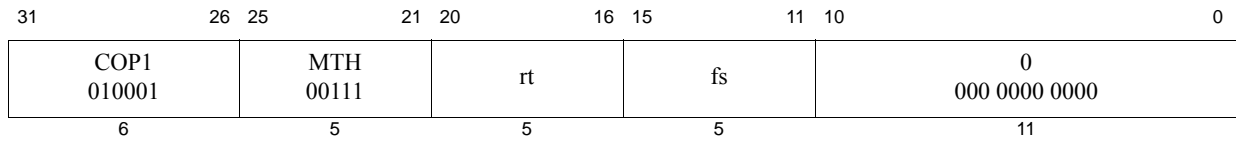

Format: MTHC1 *rt*, *fs*

MIPS32 Release 2

Purpose: Move Word to High Half of Floating Point Register

To copy a word from a GPR to the high half of an FPU (CP1) general register.

Description: $FPR[fs]_{63..32} \leftarrow GPR[rt]$

The word in GPR *rt* is placed into the high word of FPR *fs*. This instruction is primarily intended to support 64-bit floating point units on a 32-bit CPU, but the semantics of the instruction are defined for all cases.

Restrictions:

In implementations prior to Release 2 of the architecture, this instruction resulted in a Reserved Instruction exception.

The results are **UNPREDICTABLE** if $Status_{FR} = 0$ and *fs* is odd.

Operation:

```
newdata ← GPR[rt]
olddata ← ValueFPR(fs, UNINTERPRETED_DOUBLEWORD)_{31..0}
StoreFPR(fs, UNINTERPRETED_DOUBLEWORD, newdata || olddata)
```

Exceptions:

Coprocessor Unusable, Reserved Instruction

Programming Notes

When paired with MTC1 to write a value to a 64-bit FPR, the MTC1 must be executed first, followed by the MTHC1. This is because of the semantic definition of MTC1, which is not aware that software is using an MTHC1 instruction to complete the operation, and sets the upper half of the 64-bit FPR to an **UNPREDICTABLE** value.

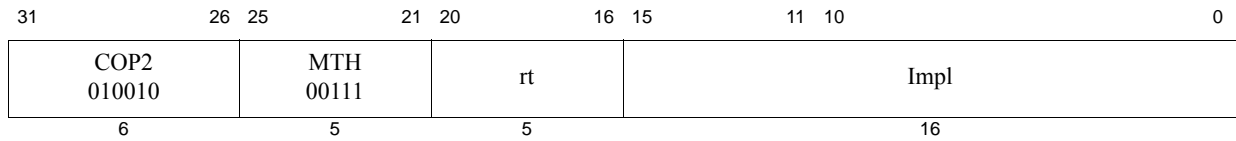

Format: MTHC2 *rt*, *Impl*
MTHC2 *rt*, *Impl*, *sel*

MIPS32 Release 2
MIPS32 Release 2

The syntax shown above is an example using MTHC1 as a model. The specific syntax is implementation dependent.

Purpose: Move Word to High Half of Coprocessor 2 Register

To copy a word from a GPR to the high half of a COP2 general register.

Description: $CP2CPR[Impl]_{63..32} \leftarrow GPR[rt]$

The word in GPR *rt* is placed into the high word of coprocessor 2 general register denoted by the *Impl* field. The interpretation of the *Impl* field is left entirely to the Coprocessor 2 implementation and is not specified by the architecture.

Restrictions:

The results are **UNPREDICTABLE** if the *Impl* field specifies a coprocessor 2 register that does not exist, or if that register is not 64 bits wide.

In implementations prior to Release 2 of the architecture, this instruction resulted in a Reserved Instruction exception.

Operation:

```
data ← GPR[rt]
CP2CPR[Impl] ← data || CPR[2,rd,sel]_{31..0}
```

Exceptions:

Coprocessor Unusable, Reserved Instruction

Programming Notes

When paired with MTC2 to write a value to a 64-bit CPR, the MTC2 must be executed first, followed by the MTHC2. This is because of the semantic definition of MTC2, which is not aware that software is using an MTHC2 instruction to complete the operation, and sets the upper half of the 64-bit CPR to an **UNPREDICTABLE** value.

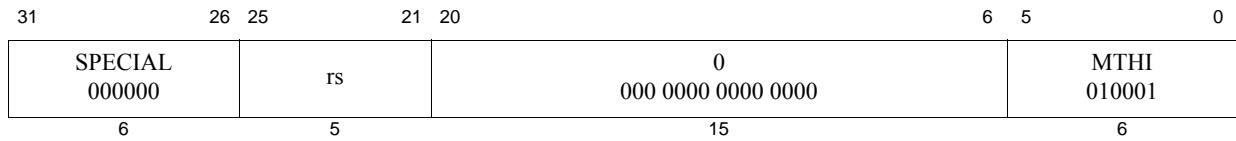

Format: MTHI rs

MIPS32, removed in Release 6

Purpose: Move to HI Register

To copy a GPR to the special purpose *HI* register.

Description: $HI \leftarrow GPR[rs]$

The contents of GPR *rs* are loaded into special register *HI*.

Restrictions:

A computed result written to the *HI/LO* pair by DIV, DIVU, MULT, or MULTU must be read by MFHI or MFLO before a new result can be written into either *HI* or *LO*.

If an MTHI instruction is executed following one of these arithmetic instructions, but before an MFLO or MFHI instruction, the contents of *LO* are **UNPREDICTABLE**. The following example shows this illegal situation:

```

MULT  r2,r4 # start operation that will eventually write to HI,LO
...      # code not containing mfhi or mflo
MTHI  r6
...      # code not containing mflo
MFLO  r3   # this mflo would get an UNPREDICTABLE value

```

Availability and Compatibility:

This instruction has been removed in Release 6.

Operation:

$HI \leftarrow GPR[rs]$

Exceptions:

None

Historical Information:

In MIPS I-III, if either of the two preceding instructions is MFHI, the result of that MFHI is **UNPREDICTABLE**. Reads of the *HI* or *LO* special register must be separated from any subsequent instructions that write to them by two or more instructions. In MIPS IV and later, including MIPS32, this restriction does not exist.

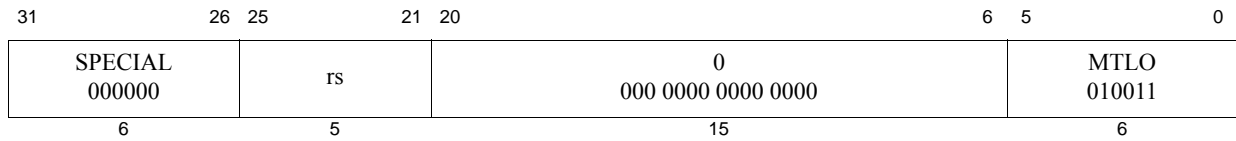

Format: MTLO rs

MIPS32, removed in Release 6

Purpose: Move to LO Register

To copy a GPR to the special purpose *LO* register.

Description: $LO \leftarrow GPR[rs]$

The contents of GPR *rs* are loaded into special register *LO*.

Restrictions:

A computed result written to the *HI/LO* pair by DIV, DIVU, MULT, or MULTU must be read by MFHI or MFLO before a new result can be written into either *HI* or *LO*.

If an MTLO instruction is executed following one of these arithmetic instructions, but before an MFLO or MFHI instruction, the contents of *HI* are **UNPREDICTABLE**. The following example shows this illegal situation:

```
MULT  r2,r4 # start operation that will eventually write to HI,LO
...      # code not containing mfhi or mflo
MTLO   r6
...      # code not containing mfhi
MFHI   r3   # this mfhi would get an UNPREDICTABLE value
```

Availability and Compatibility:

This instruction has been removed in Release 6.

Operation:

$LO \leftarrow GPR[rs]$

Exceptions:

None

Historical Information:

In MIPS I-III, if either of the two preceding instructions is MFHI, the result of that MFHI is **UNPREDICTABLE**. Reads of the *HI* or *LO* special register must be separated from any subsequent instructions that write to them by two or more instructions. In MIPS IV and later, including MIPS32, this restriction does not exist.

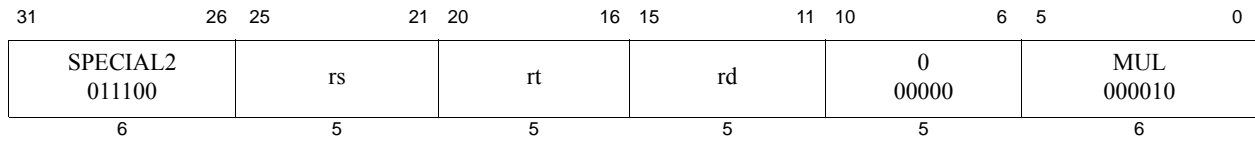

Format: MUL rd, rs, rt

MIPS32, removed in Release 6

Purpose: Multiply Word to GPR

To multiply two words and write the result to a GPR.

Description: $GPR[rd] \leftarrow GPR[rs] \times GPR[rt]$

The 32-bit word value in GPR *rs* is multiplied by the 32-bit value in GPR *rt*, treating both operands as signed values, to produce a 64-bit result. The least significant 32 bits of the product are written to GPR *rd*. The contents of *HI* and *LO* are **UNPREDICTABLE** after the operation. No arithmetic exception occurs under any circumstances.

Restrictions:

Note that this instruction does not provide the capability of writing the result to the *HI* and *LO* registers.

Availability and Compatibility:

The pre-Release 6 MUL instruction has been removed in Release 6. It has been replaced by a similar instruction of the same mnemonic, MUL, but different encoding, which is a member of a family of single-width multiply instructions. Refer to the ‘MUL’ and ‘MUH’ instructions in this manual for more information.

Operation:

```
temp ← GPR[rs] × GPR[rt]
GPR[rd] ← temp31..0
HI ← UNPREDICTABLE
LO ← UNPREDICTABLE
```

Exceptions:

None

Programming Notes:

In some processors the integer multiply operation may proceed asynchronously and allow other CPU instructions to execute before it is complete. An attempt to read GPR *rd* before the results are written interlocks until the results are ready. Asynchronous execution does not affect the program result, but offers an opportunity for performance improvement by scheduling the multiply so that other instructions can execute in parallel.

Programs that require overflow detection must check for it explicitly.

Where the size of the operands are known, software should place the shorter operand in GPR *rt*. This may reduce the latency of the instruction on those processors which implement data-dependent instruction latencies.

31	26 25	21 20	16 15	11 10	6 5	0
SPECIAL 000000	rs	rt	rd	MUL 00010	SOP30 011000	
SPECIAL 000000	rs	rt	rd	MUH 00011	SOP30 011000	
SPECIAL 000000	rs	rt	rd	MULU 00010	SOP31 011001	
SPECIAL 000000	rs	rt	rd	MUHU 00011	SOP31 011001	
6	5	5	5	5	6	

Format: MUL MUH MULU MUHU
MUL rd,rs,rt
MUH rd,rs,rt
MULU rd,rs,rt
MUHU rd,rs,rt

MIPS32 Release 6
MIPS32 Release 6
MIPS32 Release 6
MIPS32 Release 6

Purpose: Multiply Integers (with result to GPR)

MUL: Multiply Words Signed, Low Word
MUH: Multiply Words Signed, High Word
MULU: Multiply Words Unsigned, Low Word
MUHU: Multiply Words Unsigned, High Word

Description:

MUL: GPR[rd] ← lo_word(multiply.signed(GPR[rs] × GPR[rt]))
MUH: GPR[rd] ← hi_word(multiply.signed(GPR[rs] × GPR[rt]))
MULU: GPR[rd] ← lo_word(multiply.unsigned(GPR[rs] × GPR[rt]))
MUHU: GPR[rd] ← hi_word(multiply.unsigned(GPR[rs] × GPR[rt]))

The Release 6 multiply instructions multiply the operands in GPR[rs] and GPR[rd], and place the specified high or low part of the result, of the same width, in GPR[rd].

MUL performs a signed 32-bit integer multiplication, and places the low 32 bits of the result in the destination register.

MUH performs a signed 32-bit integer multiplication, and places the high 32 bits of the result in the destination register.

MULU performs an unsigned 32-bit integer multiplication, and places the low 32 bits of the result in the destination register.

MUHU performs an unsigned 32-bit integer multiplication, and places the high 32 bits of the result in the destination register.

Restrictions:

MUL behaves correctly even if its inputs are not sign extended 32-bit integers. Bits 32-63 of its inputs do not affect the result.

MULU behaves correctly even if its inputs are not zero or sign extended 32-bit integers. Bits 32-63 of its inputs do not affect the result.

Availability and Compatibility:

These instructions are introduced by and required as of Release 6.

Programming Notes:

The low half of the integer multiplication result is identical for signed and unsigned. Nevertheless, there are distinct instructions MUL MULU. Implementations may choose to optimize a multiply that produces the low half followed by a multiply that produces the upper half. Programmers are recommended to use matching lower and upper half multiplications.

The Release 6 MUL instruction has the same opcode mnemonic as the pre-Release 6 MUL instruction. The semantics of these instructions are almost identical: both produce the low 32-bits of the $32 \times 32 = 64$ product; but the pre-Release 6 MUL is unpredictable if its inputs are not properly sign extended 32-bit values on a 64 bit machine, and is defined to render the HI and LO registers unpredictable, whereas the Release 6 version ignores bits 32-63 of the input, and there are no HI/LO registers in Release 6 to be affected.

Operation:

```

MUL, MUH:
    s1 ← signed_word(GPR[rs])
    s2 ← signed_word(GPR[rt])
MULU, MUHU:
    s1 ← unsigned_word(GPR[rs])
    s2 ← unsigned_word(GPR[rt])

product ← s1 × s2    /* product is twice the width of sources */

MUL:   GPR[rd] ← lo_word( product )
MUH:   GPR[rd] ← hi_word( product )
MULU:  GPR[rd] ← lo_word( product )
MUHU:  GPR[rd] ← hi_word( product )

```

Exceptions:

None

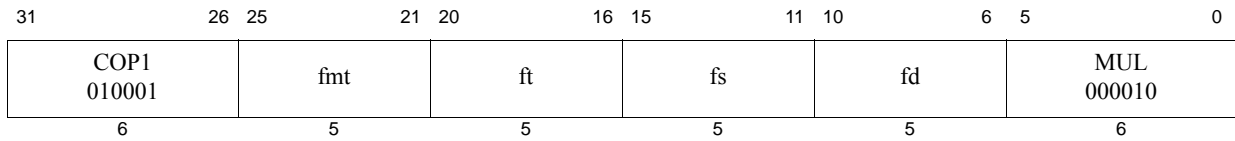

Format: MUL.fmt
 MUL.S fd, fs, ft **MIPS32**
 MUL.D fd, fs, ft **MIPS32**
 MUL.PS fd, fs, ft **MIPS64, MIPS32 Release 3, removed in Release 6**

Purpose: Floating Point Multiply

To multiply FP values.

Description: $FPR[fd] \leftarrow FPR[fs] \times FPR[ft]$

The value in FPR *fs* is multiplied by the value in FPR *ft*. The result is calculated to infinite precision, rounded according to the current rounding mode in *FCSR*, and placed into FPR *fd*. The operands and result are values in format *fmt*. MUL.PS multiplies the upper and lower halves of FPR *fs* and FPR *ft* independently, and ORs together any generated exceptional conditions.

Restrictions:

The fields *fs*, *ft*, and *fd* must specify FPRs valid for operands of type *fmt*. If the fields are not valid, the result is **UNPREDICTABLE**.

The operands must be values in format *fmt*; if they are not, the result is **UNPREDICTABLE** and the value of the operand FPRs becomes **UNPREDICTABLE**.

The result of MUL.PS is **UNPREDICTABLE** if the processor is executing in the *FR*=0 32-bit FPU register model. It is predictable if executing on a 64-bit FPU in the *FR*=1 mode, but not with *FR*=0, and not on a 32-bit FPU.

Availability and Compatibility:

MUL.PS has been removed in Release 6.

Operation:

StoreFPR (fd, fmt, ValueFPR(fs, fmt) \times_{fmt} ValueFPR(ft, fmt))

Exceptions:

Coprocessor Unusable, Reserved Instruction

Floating Point Exceptions:

Inexact, Unimplemented Operation, Invalid Operation, Overflow, Underflow

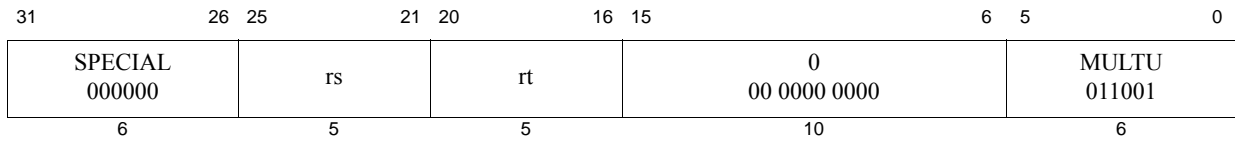

Format: MULTU *rs*, *rt*

MIPS32, removed in Release 6

Purpose: Multiply Unsigned Word

To multiply 32-bit unsigned integers.

Description: $(HI, LO) \leftarrow GPR[rs] \times GPR[rt]$

The 32-bit word value in GPR *rt* is multiplied by the 32-bit value in GPR *rs*, treating both operands as unsigned values, to produce a 64-bit result. The low-order 32-bit word of the result is placed into special register *LO*, and the high-order 32-bit word is placed into special register *HI*.

No arithmetic exception occurs under any circumstances.

Restrictions:

None

Availability and Compatibility:

The MULTU instruction has been removed in Release 6. It has been replaced by the Multiply Low (MULU) and Multiply High (MUHU) instructions, whose output is written to a single GPR. Refer to the ‘MULU’ and ‘MUHU’ instructions in this manual for more information.

Operation:

$$\begin{aligned} \text{prod} &\leftarrow (0 \parallel GPR[rs]_{31..0}) \times (0 \parallel GPR[rt]_{31..0}) \\ LO &\leftarrow \text{prod}_{31..0} \\ HI &\leftarrow \text{prod}_{63..32} \end{aligned}$$

Exceptions:

None

Programming Notes:

In some processors the integer multiply operation may proceed asynchronously and allow other CPU instructions to execute before it is complete. An attempt to read *LO* or *HI* before the results are written interlocks until the results are ready. Asynchronous execution does not affect the program result, but offers an opportunity for performance improvement by scheduling the multiply so that other instructions can execute in parallel.

Programs that require overflow detection must check for it explicitly.

Where the size of the operands are known, software should place the shorter operand in GPR *rt*. This may reduce the latency of the instruction on those processors which implement data-dependent instruction latencies.

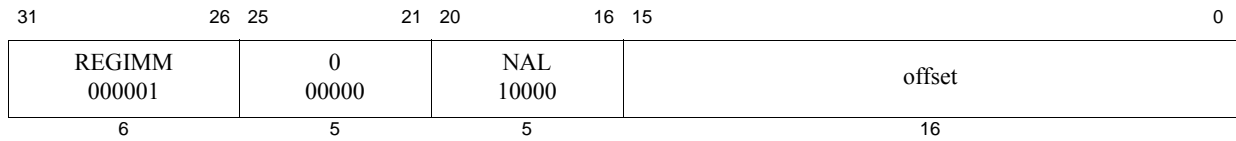

Format: NAL

Assembly Idiom MIPS32 pre-Release 6, MIPS32 Release 6

Purpose: No-op and Link

Description: $\text{GPR}[31] \leftarrow \text{PC} + 8$

NAL is an instruction used to read the PC.

NAL was originally an alias for pre-Release 6 instruction BLTZAL. The condition is false, so the 16-bit target offset field is ignored, but the link register, GPR 31, is unconditionally written with the address of the instruction past the delay slot.

Restrictions:

NAL is considered to be a not-taken branch, with a delay slot, and may not be followed by instructions not allowed in delay slots. Nor is NAL allowed in a delay slot or forbidden slot.

Availability and Compatibility:

This is a deprecated instruction in Release 6. It is strongly recommended not to use this deprecated instructions because it will be removed from a future revision of the MIPS Architecture.

The pre-Release 6 instruction BLTZAL when rs is not GPR[0], is removed in Release 6, and is required to signal a Reserved Instruction exception. Release 6 adds BLTZALC, the equivalent compact conditional branch and link, with no delay slot.

This instruction, NAL, is introduced by and required as of Release 6, the mnemonic NAL becomes distinguished from the BLTZAL instruction removed in Release 6. The NAL instruction encoding, however, works on all implementations, both pre-Release 6, where it was a special case of BLEZAL, and Release 6, where it is an instruction in its own right.

NAL is provided only for compatibility with pre-Release 6 software. It is recommended that you use ADDIU to generate a PC-relative address.

Exceptions:

None

Operation:

$\text{GPR}[31] \leftarrow \text{PC} + 8$

31	26 25	21 20	16 15	11 10	6 5	0
COP1 010001	fmt	0 00000	fs	fd	NEG 000111	
6	5	5	5	5	6	

Format: NEG.fmt

NEG.S fd, fs

NEG.D fd, fs

NEG.PS fd, fs

MIPS32

MIPS32

MIPS32 Release 2, removed in Release 6

Purpose: Floating Point Negate

To negate an FP value.

Description: $FPR[fd] \leftarrow -FPR[fs]$

The value in FPR *fs* is negated and placed into FPR *fd*. The value is negated by changing the sign bit value. The operand and result are values in format *fmt*. NEG.PS negates the upper and lower halves of FPR *fs* independently, and ORs together any generated exceptional conditions.

If $FIR_{Has2008}=0$ or $FCSR_{ABS2008}=0$ then this operation is arithmetic. For this case, any NaN operand signals invalid operation.

If $FCSR_{ABS2008}=1$ then this operation is non-arithmetic. For this case, both regular floating point numbers and NaN values are treated alike, only the sign bit is affected by this instruction. No IEEE 754 exception can be generated for this case, and the $FCSR_{Cause}$ and $FCSR_{Flags}$ fields are not modified.

Restrictions:

The fields *fs* and *fd* must specify FPRs valid for operands of type *fmt*. If the fields are not valid, the result is **UNPREDICTABLE**. The operand must be a value in format *fmt*; if it is not, the result is **UNPREDICTABLE** and the value of the operand FPR becomes **UNPREDICTABLE**.

The result of NEG.PS is **UNPREDICTABLE** if the processor is executing in the $FR=0$ 32-bit FPU register model. It is predictable if executing on a 64-bit FPU in the $FR=1$ mode, but not with $FR=0$, and not on a 32-bit FPU.

Availability and Compatibility:

NEG.PS has been removed in Release 6.

Operation:

$\text{StoreFPR}(fd, fmt, \text{Negate}(\text{ValueFPR}(fs, fmt)))$

Exceptions:

Coprocessor Unusable, Reserved Instruction

Floating Point Exceptions:

Unimplemented Operation, Invalid Operation

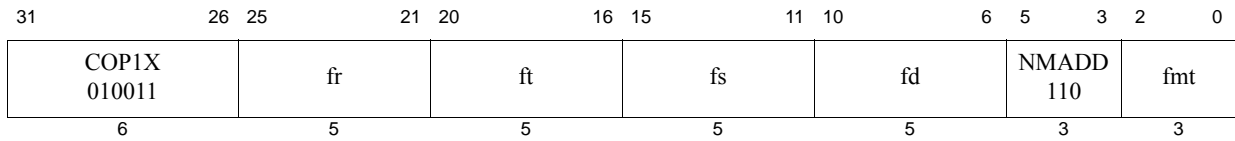

Format: NMADD.fmt
 NMADD.S fd, fr, fs, ft
 NMADD.D fd, fr, fs, ft
 NMADD.PS fd, fr, fs, ft

MIPS32 Release 2, removed in Release 6
MIPS32 Release 2, removed in Release 6
MIPS32 Release 2, removed in Release 6

Purpose: Floating Point Negative Multiply Add

To negate a combined multiply-then-add of FP values.

Description: $FPR[fd] \leftarrow - ((FPR[fs] \times FPR[ft]) + FPR[fr])$

The value in FPR *fs* is multiplied by the value in FPR *ft* to produce an intermediate product. The intermediate product is rounded according to the current rounding mode in *FCSR*. The value in FPR *fr* is added to the product.

The result sum is calculated to infinite precision, rounded according to the current rounding mode in *FCSR*, negated by changing the sign bit, and placed into FPR *fd*. The operands and result are values in format *fmt*. The results and flags are as if separate floating-point multiply and add and negate instructions were executed.

NMADD.PS applies the operation to the upper and lower halves of FPR *fr*, FPR *fs*, and FPR *ft* independently, and ORs together any generated exceptional conditions.

The *Cause* bits are ORed into the *Flag* bits if no exception is taken.

Restrictions:

The fields *fr*, *fs*, *ft*, and *fd* must specify FPRs valid for operands of type *fmt*. If the fields are not valid, the result is **UNPREDICTABLE**.

The operands must be values in format *fmt*; if they are not, the result is **UNPREDICTABLE** and the value of the operand FPRs becomes **UNPREDICTABLE**.

The result of NMADD.PS is **UNPREDICTABLE** if the processor is executing in the *FR=0* 32-bit FPU register model. It is predictable if executing on a 64-bit FPU in the *FR=1* mode, but not with *FR=0*, and not on a 32-bit FPU.

Availability and Compatibility:

This instruction has been removed in Release 6.

NMADD.S and NMADD.D: Required in all versions of MIPS64 since MIPS64 Release 1. Not available in MIPS32 Release 1. Required by MIPS32 Release 2 and subsequent versions of MIPS32. When required, these instructions are to be implemented if an FPU is present, either in a 32-bit or 64-bit FPU or in a 32-bit or 64-bit FP Register Mode (*FIR_{F64}*=0 or 1, *Status_{FR}*=0 or 1).

Operation:

$vfr \leftarrow \text{ValueFPR}(fr, fmt)$
 $vfs \leftarrow \text{ValueFPR}(fs, fmt)$
 $vft \leftarrow \text{ValueFPR}(ft, fmt)$
 $\text{StoreFPR}(fd, fmt, -(vfr +_{fmt} (vfs \times_{fmt} vft)))$

Exceptions:

Coprocessor Unusable, Reserved Instruction

Floating Point Exceptions:

Inexact, Unimplemented Operation, Invalid Operation, Overflow, Underflow

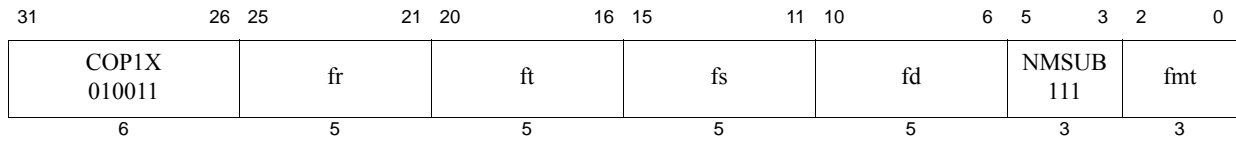

Format: NMSUB.fmt
 NMSUB.S fd, fr, fs, ft
 NMSUB.D fd, fr, fs, ft
 NMSUB.PS fd, fr, fs, ft

MIPS32 Release 2, removed in Release 6
MIPS32 Release 2, removed in Release 6
MIPS32 Release 2, removed in Release 6

Purpose: Floating Point Negative Multiply Subtract

To negate a combined multiply-then-subtract of FP values.

Description: $FPR[fd] \leftarrow ((FPR[fs] \times FPR[ft]) - FPR[fr])$

The value in FPR *fs* is multiplied by the value in FPR *ft* to produce an intermediate product. The intermediate product is rounded according to the current rounding mode in *FCSR*. The value in FPR *fr* is subtracted from the product.

The result is calculated to infinite precision, rounded according to the current rounding mode in *FCSR*, negated by changing the sign bit, and placed into FPR *fd*. The operands and result are values in format *fmt*. The results and flags are as if separate floating-point multiply and subtract and negate instructions were executed.

NMSUB.PS applies the operation to the upper and lower halves of FPR *fr*, FPR *fs*, and FPR *ft* independently, and ORs together any generated exceptional conditions.

The *Cause* bits are ORed into the *Flag* bits if no exception is taken.

Restrictions:

The fields *fr*, *fs*, *ft*, and *fd* must specify FPRs valid for operands of type *fmt*. If the fields are not valid, the result is **UNPREDICTABLE**.

The operands must be values in format *fmt*; if they are not, the result is **UNPREDICTABLE** and the value of the operand FPRs becomes **UNPREDICTABLE**.

The result of NMSUB.PS is **UNPREDICTABLE** if the processor is executing in the *FR*=0 32-bit FPU register model. It is predictable if executing on a 64-bit FPU in the *FR*=1 mode, but not with *FR*=0 and not on a 32-bit FPU.

Availability and Compatibility:

This instruction has been removed in Release 6.

NMSUB.S and NMSUB.D: Required in all versions of MIPS64 since MIPS64 Release 1. Not available in MIPS32 Release 1. Required in MIPS32 Release 2 and all subsequent versions of MIPS32. When required, these instructions are to be implemented if an FPU is present, either in a 32-bit or 64-bit FPU or in a 32-bit or 64-bit FP Register Mode ($FIR_{F64}=0$ or 1, $Status_{FR}=0$ or 1).

Operation:

```
vfr ← ValueFPR(fr, fmt)
vfs ← ValueFPR(fs, fmt)
vft ← ValueFPR(ft, fmt)
StoreFPR(fd, fmt, -((vfs ×fmt vft) -fmt vfr))
```

Exceptions:

Coprocessor Unusable, Reserved Instruction

Floating Point Exceptions:

Inexact, Unimplemented Operation, Invalid Operation, Overflow, Underflow

31	26 25	21 20	16 15	11 10	6 5	0
SPECIAL 000000	0 00000	0 00000	0 00000	0 00000	0 00000	SLL 000000
6	5	5	5	5	5	6

Format: NOP

Assembly Idiom

Purpose: No Operation

To perform no operation.

Description:

NOP is the assembly idiom used to denote no operation. The actual instruction is interpreted by the hardware as SLL r0, r0, 0.

Restrictions:

None

Operations:

None

Exceptions:

None

Programming Notes:

The zero instruction word, which represents SLL, r0, r0, 0, is the preferred NOP for software to use to fill branch and jump delay slots and to pad out alignment sequences.

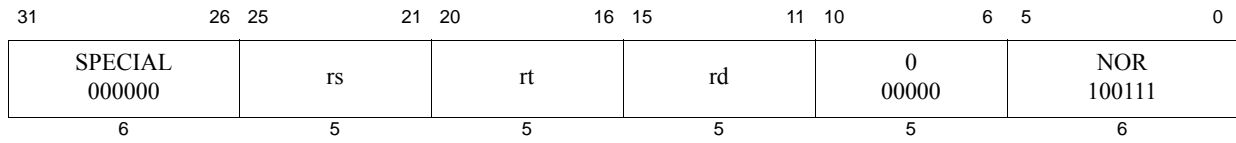

Format: NOR *rd*, *rs*, *rt*

MIPS32

Purpose: Not Or

To do a bitwise logical NOT OR.

Description: $GPR[rd] \leftarrow GPR[rs] \text{ nor } GPR[rt]$

The contents of GPR *rs* are combined with the contents of GPR *rt* in a bitwise logical NOR operation. The result is placed into GPR *rd*.

Restrictions:

None

Operation:

$GPR[rd] \leftarrow GPR[rs] \text{ nor } GPR[rt]$

Exceptions:

None

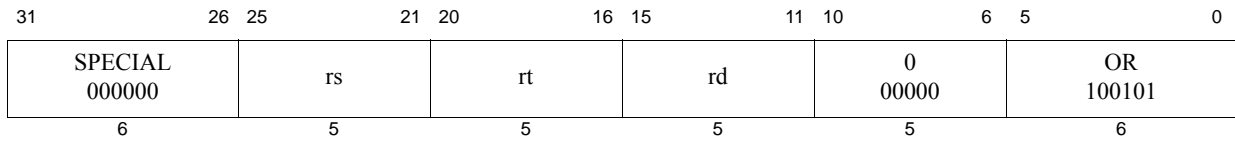

Format: OR *rd*, *rs*, *rt*

MIPS32

Purpose: Or

To do a bitwise logical OR.

Description: $GPR[rd] \leftarrow GPR[rs] \text{ or } GPR[rt]$

The contents of GPR *rs* are combined with the contents of GPR *rt* in a bitwise logical OR operation. The result is placed into GPR *rd*.

Restrictions:

None

Operations:

$GPR[rd] \leftarrow GPR[rs] \text{ or } GPR[rt]$

Exceptions:

None

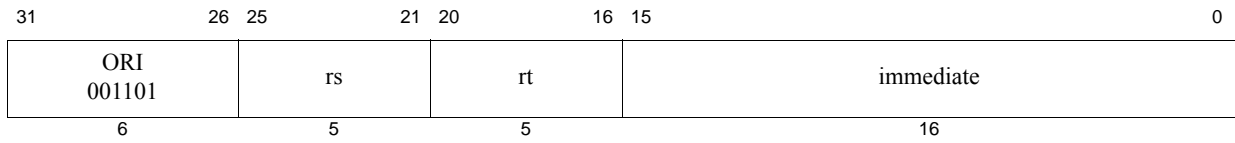

Format: ORI *rt*, *rs*, *immediate*

MIPS32

Purpose: Or Immediate

To do a bitwise logical OR with a constant.

Description: $GPR[rt] \leftarrow GPR[rs] \text{ or } immediate$

The 16-bit *immediate* is zero-extended to the left and combined with the contents of GPR *rs* in a bitwise logical OR operation. The result is placed into GPR *rt*.

Restrictions:

None

Operations:

$GPR[rt] \leftarrow GPR[rs] \text{ or } zero_extend(immediate)$

Exceptions:

None

31	26	25	24	21	20	16	15	11	10	6	5	0
SPECIAL 000000	0 00000			0 00000		0 00000		5 00101		SLL 000000		
6	5			5		5		5		6		

Format: PAUSE

MIPS32 Release 2/MT Module

Purpose: Wait for the LLBit to clear.

Description:

Locks implemented using the LL/SC instructions are a common method of synchronization between threads of control. A lock implementation does a load-linked instruction and checks the value returned to determine whether the software lock is set. If it is, the code branches back to retry the load-linked instruction, implementing an active busy-wait sequence. The PAUSE instruction is intended to be placed into the busy-wait sequence to block the instruction stream until such time as the load-linked instruction has a chance to succeed in obtaining the software lock.

The PAUSE instruction is implementation-dependent, but it usually involves descheduling the instruction stream until the LLBit is zero.

- In a single-threaded processor, this may be implemented as a short-term WAIT operation which resumes at the next instruction when the LLBit is zero or on some other external event such as an interrupt.
- On a multi-threaded processor, this may be implemented as a short term YIELD operation which resumes at the next instruction when the LLBit is zero.

In either case, it is assumed that the instruction stream which gives up the software lock does so via a write to the lock variable, which causes the processor to clear the LLBit as seen by this thread of execution.

The encoding of the instruction is such that it is backward compatible with all previous implementations of the architecture. The PAUSE instruction can therefore be placed into existing lock sequences and treated as a NOP by the processor, even if the processor does not implement the PAUSE instruction.

Restrictions:

Pre-Release 6: The operation of the processor is **UNPREDICTABLE** if a PAUSE instruction is executed placed in the delay slot of a branch or jump instruction.

Release 6: Implementations are required to signal a Reserved Instruction exception if PAUSE is encountered in the delay slot or forbidden slot of a branch or jump instruction.

Operations:

```

if LLBit ≠ 0 then
    EPC ← PC + 4                /* Resume at the following instruction */
    DescheduleInstructionStream()
endif

```

Exceptions:

None

Programming Notes:

The PAUSE instruction is intended to be inserted into the instruction stream after an LL instruction has set the LLBit and found the software lock set. The program may wait forever if a PAUSE instruction is executed and there is no possibility that the LLBit will ever be cleared.

An example use of the PAUSE instruction is shown below:

```
acquire_lock:
    ll    t0, 0(a0)           /* Read software lock, set hardware lock */
    bnezc t0, acquire_lock_retry: /* Branch if software lock is taken; */
                                     /* Release 6 branch */
    addiu t0, t0, 1           /* Set the software lock */
    sc    t0, 0(a0)           /* Try to store the software lock */
    bnezc t0, 10f             /* Branch if lock acquired successfully */
    sync
acquire_lock_retry:
    pause                               /* Wait for LLBIT to clear before retry */
    bc    acquire_lock           /* and retry the operation; Release 6 branch */
10:

    Critical region code

release_lock:
    sync
    sw    zero, 0(a0)          /* Release software lock, clearing LLBIT */
                                     /* for any PAUSED waiters */
```

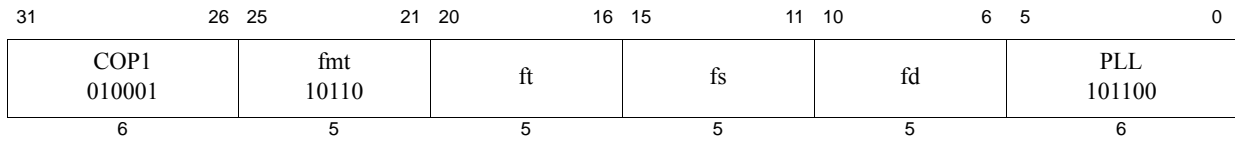

Format: PLL.PS *fd*, *fs*, *ft*

MIPS32 Release 2, removed in Release 6

Purpose: Pair Lower Lower

To merge a pair of paired single values with realignment.

Description: $FPR[fd] \leftarrow \text{lower}(FPR[fs]) \ || \ \text{lower}(FPR[ft])$

A new paired-single value is formed by concatenating the lower single of FPR *fs* (bits **31..0**) and the lower single of FPR *ft* (bits **31..0**).

The move is non-arithmetic; it causes no IEEE 754 exceptions, and the *FCSR_{Cause}* and *FCSR_{Flags}* fields are not modified.

Restrictions:

The fields *fs*, *ft*, and *fd* must specify FPRs valid for operands of type *PS*. If the fields are not valid, the result is **UNPREDICTABLE**.

The result of this instruction is **UNPREDICTABLE** if the processor is executing in the *FR=0* 32-bit FPU register model. It is predictable if executing on a 64-bit FPU in the *FR=1* mode, but not with *FR=0*, and not on a 32-bit FPU.

Availability and Compatibility:

This instruction has been removed in Release 6.

Operation:

$\text{StoreFPR}(fd, PS, \text{ValueFPR}(fs, PS)_{31..0} \ || \ \text{ValueFPR}(ft, PS)_{31..0})$

Exceptions:

Coprocessor Unusable, Reserved Instruction

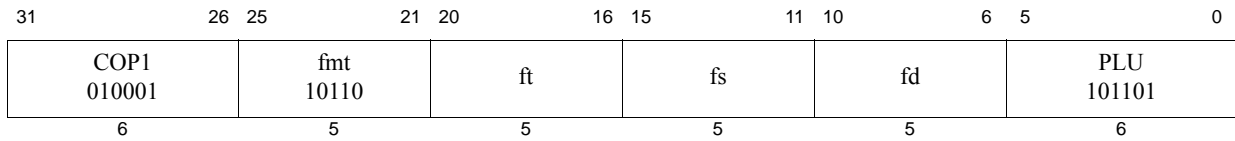

Format: PLU.PS *fd*, *fs*, *ft*

MIPS32 Release 2, removed in Release 6

Purpose: Pair Lower Upper

To merge a pair of paired single values with realignment.

Description: $FPR[fd] \leftarrow \text{lower}(FPR[fs]) \parallel \text{upper}(FPR[ft])$

A new paired-single value is formed by concatenating the lower single of FPR *fs* (bits **31..0**) and the upper single of FPR *ft* (bits **63..32**).

The move is non-arithmetic; it causes no IEEE 754 exceptions, and the $FCSR_{Cause}$ and $FCSR_{Flags}$ fields are not modified.

Restrictions:

The fields *fs*, *ft*, and *fd* must specify FPRs valid for operands of type *PS*. If the fields are not valid, the result is **UNPREDICTABLE**.

The result of this instruction is **UNPREDICTABLE** if the processor is executing in the $FR=0$ 32-bit FPU register model. It is predictable if executing on a 64-bit FPU in the $FR=1$ mode, but not with $FR=0$, and not on a 32-bit FPU.

Availability and Compatibility:

This instruction has been removed in Release 6.

Operation:

$\text{StoreFPR}(fd, PS, \text{ValueFPR}(fs, PS)_{31..0} \parallel \text{ValueFPR}(ft, PS)_{63..32})$

Exceptions:

Coprocessor Unusable, Reserved Instruction

pre-Release 6

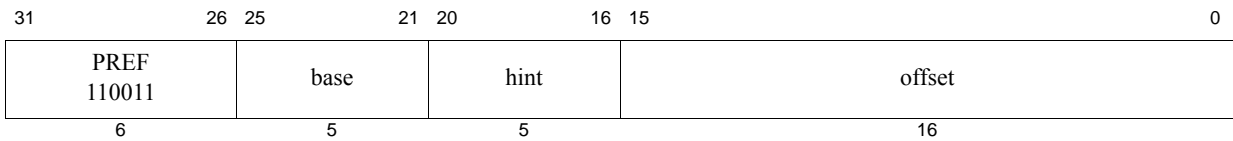

Release 6

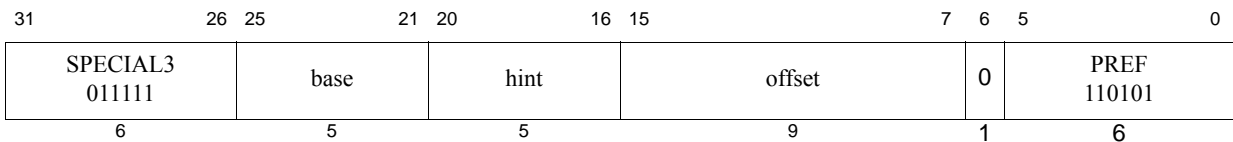

Format: PREF hint,offset(base)

MIPS32

Purpose: Prefetch

To move data between memory and cache.

Description: `prefetch_memory(GPR[base] + offset)`

PREF adds the signed *offset* to the contents of GPR *base* to form an effective byte address. The *hint* field supplies information about the way that the data is expected to be used.

PREF enables the processor to take some action, typically causing data to be moved to or from the cache, to improve program performance. The action taken for a specific PREF instruction is both system and context dependent. Any action, including doing nothing, is permitted as long as it does not change architecturally visible state or alter the meaning of a program. Implementations are expected either to do nothing, or to take an action that increases the performance of the program. The PrepareForStore function is unique in that it may modify the architecturally visible state.

PREF does not cause addressing-related exceptions, including TLB exceptions. If the address specified would cause an addressing exception, the exception condition is ignored and no data movement occurs. However even if no data is moved, some action that is not architecturally visible, such as writeback of a dirty cache line, can take place.

It is implementation dependent whether a Bus Error or Cache Error exception is reported if such an error is detected as a byproduct of the action taken by the PREF instruction.

PREF neither generates a memory operation nor modifies the state of a cache line for a location with an *uncached* memory access type, whether this type is specified by the address segment (e.g., *kseg1*), the programmed cacheability and coherency attribute of a segment (e.g., the use of the *K0*, *KU*, or *K23* fields in the *Config* register), or the per-page cacheability and coherency attribute provided by the TLB.

If PREF results in a memory operation, the memory access type and cacheability&coherency attribute used for the operation are determined by the memory access type and cacheability&coherency attribute of the effective address, just as it would be if the memory operation had been caused by a load or store to the effective address.

For a cached location, the expected and useful action for the processor is to prefetch a block of data that includes the effective address. The size of the block and the level of the memory hierarchy it is fetched into are implementation specific.

In coherent multiprocessor implementations, if the effective address uses a coherent Cacheability and Coherency Attribute (CCA), then the instruction causes a coherent memory transaction to occur. This means a prefetch issued on one processor can cause data to be evicted from the cache in another processor.

The PREF instruction and the memory transactions which are sourced by the PREF instruction, such as cache refill or cache writeback, obey the ordering and completion rules of the SYNC instruction.

Table 5.2 Values of *hint* Field for PREF Instruction

Value	Name	Data Use and Desired Prefetch Action
0	load	Use: Prefetched data is expected to be read (not modified). Action: Fetch data as if for a load.
1	store	Use: Prefetched data is expected to be stored or modified. Action: Fetch data as if for a store.
2	L1 LRU hint	Pre-Release 6: Reserved for Architecture. Release 6: Implementation dependent. This hint code marks the line as LRU in the L1 cache and thus preferred for next eviction. Implementations can choose to writeback and/or invalidate as long as no architectural state is modified.
3	Reserved for Implementation	Pre-Release 6: Reserved for Architecture. Release 6: Available for implementation-dependent use.
4	load_streamed	Use: Prefetched data is expected to be read (not modified) but not reused extensively; it “streams” through cache. Action: Fetch data as if for a load and place it in the cache so that it does not displace data prefetched as “retained.”
5	store_streamed	Use: Prefetched data is expected to be stored or modified but not reused extensively; it “streams” through cache. Action: Fetch data as if for a store and place it in the cache so that it does not displace data prefetched as “retained.”
6	load_retained	Use: Prefetched data is expected to be read (not modified) and reused extensively; it should be “retained” in the cache. Action: Fetch data as if for a load and place it in the cache so that it is not displaced by data prefetched as “streamed.”
7	store_retained	Use: Prefetched data is expected to be stored or modified and reused extensively; it should be “retained” in the cache. Action: Fetch data as if for a store and place it in the cache so that it is not displaced by data prefetched as “streamed.”
8-15	L2 operation	Pre-Release 6: Reserved for Architecture. Release 6: In the Release 6 architecture, hint codes 8 - 15 are treated the same as hint codes 0 - 7 respectively, but operate on the L2 cache.
16-23	L3 operation	Pre-Release 6: Reserved for Architecture. Release 6: In the Release 6 architecture, hint codes 16 - 23 are treated the same as hint codes 0 - 7 respectively, but operate on the L3 cache.
24	Reserved for Architecture	Pre-Release 6: Unassigned by the Architecture - available for implementation-dependent use. Release 6: This hint code is not implemented in the Release 6 architecture and generates a Reserved Instruction exception (RI).

Table 5.2 Values of *hint* Field for PREF Instruction (Continued)

Value	Name	Data Use and Desired Prefetch Action
25	writeback_invalidate (also known as “nudge”) Reserved for Architecture in Release 6	Pre-Release 6: Use—Data is no longer expected to be used. Action—For a writeback cache, schedule a writeback of any dirty data. At the completion of the writeback, mark the state of any cache lines written back as invalid. If the cache line is not dirty, it is implementation dependent whether the state of the cache line is marked invalid or left unchanged. If the cache line is locked, no action is taken. Release 6: This hint code is not implemented in the Release 6 architecture and generates a Reserved Instruction exception (RI).
26-29	Reserved for Architecture	Pre-Release 6: Unassigned by the Architecture—available for implementation-dependent use. Release 6: These hints are not implemented in the Release 6 architecture and generate a Reserved Instruction exception (RI).
30	PrepareForStore Reserved for Architecture in Release 6	Pre-Release 6: Use—Prepare the cache for writing an entire line, without the overhead involved in filling the line from memory. Action—If the reference hits in the cache, no action is taken. If the reference misses in the cache, a line is selected for replacement, any valid and dirty victim is written back to memory, the entire line is filled with zero data, and the state of the line is marked as valid and dirty. Programming Note: Because the cache line is filled with zero data on a cache miss, software must not assume that this action, in and of itself, can be used as a fast bzero-type function. Release 6: This hint is not implemented in the Release 6 architecture and generates a Reserved Instruction exception (RI).
31	Reserved for Architecture	Pre-Release 6: Unassigned by the Architecture—available for implementation-dependent use. Release 6: This hint is not implemented in the Release 6 architecture and generates a Reserved Instruction exception (RI).

Restrictions:

None

This instruction does not produce an exception for a misaligned memory address, since it has no memory access size.

Availability and Compatibility:

This instruction has been recoded for Release 6.

Operation:

```
vAddr ← GPR[base] + sign_extend(offset)
(pAddr, CCA) ← AddressTranslation(vAddr, DATA, LOAD)
Prefetch(CCA, pAddr, vAddr, DATA, hint)
```

Exceptions:

Bus Error, Cache Error

Prefetch does not take any TLB-related or address-related exceptions under any circumstances.

Programming Notes:

In the Release 6 architecture, hint codes 2:3, 10:11, 18:19 behave as a NOP if not implemented. Hint codes 24:31 are

not implemented (treated as reserved) and always signal a Reserved Instruction exception (RI).

As shown in the instruction drawing above, Release 6 implements a 9-bit offset, whereas all release levels lower than Release 6 of the MIPS architecture implement a 16-bit offset.

Prefetch cannot move data to or from a mapped location unless the translation for that location is present in the TLB. Locations in memory pages that have not been accessed recently may not have translations in the TLB, so prefetch may not be effective for such locations.

Prefetch does not cause addressing exceptions. A prefetch may be used using an address pointer before the validity of the pointer is determined without worrying about an addressing exception.

It is implementation dependent whether a Bus Error or Cache Error exception is reported if such an error is detected as a byproduct of the action taken by the PREF instruction. Typically, this only occurs in systems which have high-reliability requirements.

Prefetch operations have no effect on cache lines that were previously locked with the CACHE instruction.

Hint field encodings whose function is described as “streamed” or “retained” convey usage intent from software to hardware. Software should not assume that hardware will always prefetch data in an optimal way. If data is to be truly retained, software should use the Cache instruction to lock data into the cache.

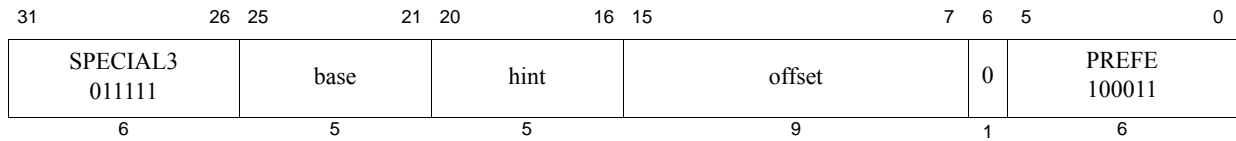

Format: PREFE hint,offset(base)

MIPS32

Purpose: Prefetch EVA

To move data between user mode virtual address space memory and cache while operating in kernel mode.

Description: `prefetch_memory(GPR[base] + offset)`

PREFE adds the 9-bit signed *offset* to the contents of GPR *base* to form an effective byte address. The *hint* field supplies information about the way that the data is expected to be used.

PREFE enables the processor to take some action, causing data to be moved to or from the cache, to improve program performance. The action taken for a specific PREFE instruction is both system and context dependent. Any action, including doing nothing, is permitted as long as it does not change architecturally visible state or alter the meaning of a program. Implementations are expected either to do nothing, or to take an action that increases the performance of the program. The PrepareForStore function is unique in that it may modify the architecturally visible state.

PREFE does not cause addressing-related exceptions, including TLB exceptions. If the address specified would cause an addressing exception, the exception condition is ignored and no data movement occurs. However even if no data is moved, some action that is not architecturally visible, such as writeback of a dirty cache line, can take place.

It is implementation dependent whether a Bus Error or Cache Error exception is reported if such an error is detected as a byproduct of the action taken by the PREFE instruction.

PREFE neither generates a memory operation nor modifies the state of a cache line for a location with an *uncached* memory access type, whether this type is specified by the address segment (for example, *kseg1*), the programmed cacheability and coherency attribute of a segment (for example, the use of the *K0*, *KU*, or *K23* fields in the *Config* register), or the per-page cacheability and coherency attribute provided by the TLB.

If PREFE results in a memory operation, the memory access type and cacheability & coherency attribute used for the operation are determined by the memory access type and cacheability & coherency attribute of the effective address, just as it would be if the memory operation had been caused by a load or store to the effective address.

For a cached location, the expected and useful action for the processor is to prefetch a block of data that includes the effective address. The size of the block and the level of the memory hierarchy it is fetched into are implementation specific.

In coherent multiprocessor implementations, if the effective address uses a coherent Cacheability and Coherency Attribute (CCA), then the instruction causes a coherent memory transaction to occur. This means a prefetch issued on one processor can cause data to be evicted from the cache in another processor.

The PREFE instruction and the memory transactions which are sourced by the PREFE instruction, such as cache refill or cache writeback, obey the ordering and completion rules of the SYNC instruction.

The PREFE instruction functions in exactly the same fashion as the PREF instruction, except that address translation is performed using the user mode virtual address space mapping in the TLB when accessing an address within a memory segment configured to use the MUSUK access mode. Memory segments using UUSK or MUSK access modes are also accessible. Refer to Volume III, Enhanced Virtual Addressing section for additional information.

Implementation of this instruction is specified by the *Config5_{EVA}* field being set to one.

Table 5.3 Values of *hint* Field for PREFE Instruction

Value	Name	Data Use and Desired Prefetch Action
0	load	Use: Prefetched data is expected to be read (not modified). Action: Fetch data as if for a load.
1	store	Use: Prefetched data is expected to be stored or modified. Action: Fetch data as if for a store.
2	L1 LRU hint	Pre-Release 6: Reserved for Architecture. Release 6: Implementation dependent. This hint code marks the line as LRU in the L1 cache and thus preferred for next eviction. Implementations can choose to writeback and/or invalidate as long as no architectural state is modified.
3	Reserved for Implementation	Pre-Release 6: Reserved for Architecture. Release 6: Available for implementation-dependent use.
4	load_streamed	Use: Prefetched data is expected to be read (not modified) but not reused extensively; it “streams” through cache. Action: Fetch data as if for a load and place it in the cache so that it does not displace data prefetched as “retained.”
5	store_streamed	Use: Prefetched data is expected to be stored or modified but not reused extensively; it “streams” through cache. Action: Fetch data as if for a store and place it in the cache so that it does not displace data prefetched as “retained.”
6	load_retained	Use: Prefetched data is expected to be read (not modified) and reused extensively; it should be “retained” in the cache. Action: Fetch data as if for a load and place it in the cache so that it is not displaced by data prefetched as “streamed.”
7	store_retained	Use: Prefetched data is expected to be stored or modified and reused extensively; it should be “retained” in the cache. Action: Fetch data as if for a store and place it in the cache so that it is not displaced by data prefetched as “streamed.”
8-15	L2 operation	Pre-Release 6: Reserved for Architecture. Release 6: Hint codes 8 - 15 are treated the same as hint codes 0 - 7 respectively, but operate on the L2 cache.
16-23	L3 operation	Pre-Release 6: Reserved for Architecture. Release 6: Hint codes 16 - 23 are treated the same as hint codes 0 - 7 respectively, but operate on the L3 cache.
24	Reserved for Architecture	Pre-Release 6: Unassigned by the Architecture - available for implementation-dependent use. Release 6: This hint code is not implemented in the Release 6 architecture and generates a Reserved Instruction exception (RI).

Table 5.3 Values of *hint* Field for PREFE Instruction (Continued)

Value	Name	Data Use and Desired Prefetch Action
25	writeback_invalidate (also known as “nudge”) Reserved for Architecture in Release 6	Pre-Release 6: Use—Data is no longer expected to be used. Action—For a writeback cache, schedule a writeback of any dirty data. At the completion of the writeback, mark the state of any cache lines written back as invalid. If the cache line is not dirty, it is implementation dependent whether the state of the cache line is marked invalid or left unchanged. If the cache line is locked, no action is taken. Release 6: This hint code is not implemented in the Release 6 architecture and generates a Reserved Instruction exception (RI).
26-29	Reserved for Architecture	Pre-Release 6: Unassigned by the Architecture - available for implementation-dependent use. Release 6: These hint codes are not implemented in the Release 6 architecture and generate a Reserved Instruction exception (RI).
30	PrepareForStore Reserved for Architecture in Release 6	Pre-Release 6: Use—Prepare the cache for writing an entire line, without the overhead involved in filling the line from memory. Action—If the reference hits in the cache, no action is taken. If the reference misses in the cache, a line is selected for replacement, any valid and dirty victim is written back to memory, the entire line is filled with zero data, and the state of the line is marked as valid and dirty. Programming Note: Because the cache line is filled with zero data on a cache miss, software must not assume that this action, in and of itself, can be used as a fast bzero-type function. Release 6: This hint code is not implemented in the Release 6 architecture and generates a Reserved Instruction exception (RI).
31	Reserved for Architecture	Pre-Release 6: Unassigned by the Architecture - available for implementation-dependent use. Release 6: This hint code is not implemented in the Release 6 architecture and generates a Reserved Instruction exception (RI).

Restrictions:

Only usable when access to Coprocessor0 is enabled and when accessing an address within a segment configured using UUSK, MUSK or MUSUK access mode.

This instruction does not produce an exception for a misaligned memory address, since it has no memory access size.

Operation:

```
vAddr ← GGPR[base] + sign_extend(offset)
(pAddr, CCA) ← AddressTranslation(vAddr, DATA, LOAD)
Prefetch(CCA, pAddr, vAddr, DATA, hint)
```

Exceptions:

Bus Error, Cache Error, Address Error, Reserved Instruction, Coprocessor Usable

Prefetch does not take any TLB-related or address-related exceptions under any circumstances.

Programming Notes:

In the Release 6 architecture, hint codes 0:23 behave as a NOP and never signal a Reserved Instruction exception (RI). Hint codes 24:31 are not implemented (treated as reserved) and always signal a Reserved Instruction exception (RI).

Prefetch cannot move data to or from a mapped location unless the translation for that location is present in the TLB. Locations in memory pages that have not been accessed recently may not have translations in the TLB, so prefetch may not be effective for such locations.

Prefetch does not cause addressing exceptions. A prefetch may be used using an address pointer before the validity of the pointer is determined without worrying about an addressing exception.

It is implementation dependent whether a Bus Error or Cache Error exception is reported if such an error is detected as a byproduct of the action taken by the PREFE instruction. Typically, this only occurs in systems which have high-reliability requirements.

Prefetch operations have no effect on cache lines that were previously locked with the CACHE instruction.

Hint field encodings whose function is described as “streamed” or “retained” convey usage intent from software to hardware. Software should not assume that hardware will always prefetch data in an optimal way. If data is to be truly retained, software should use the Cache instruction to lock data into the cache.

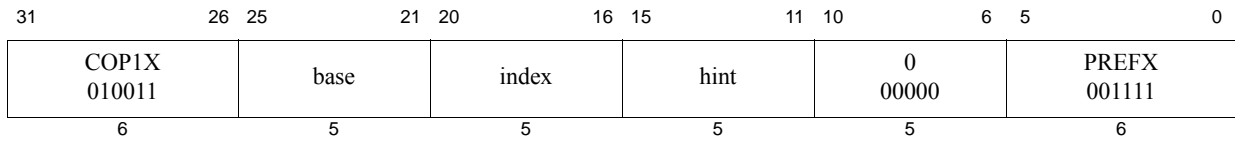

Format: `PREFX hint, index(base)`

MIPS64, MIPS32 Release 2, removed in Release 6

Purpose: Prefetch Indexed

To move data between memory and cache.

Description: `prefetch_memory[GPR[base] + GPR[index]]`

PREFX adds the contents of GPR *index* to the contents of GPR *base* to form an effective byte address. The *hint* field supplies information about the way the data is expected to be used.

The only functional difference between the PREF and PREFX instructions is the addressing mode implemented by the two. Refer to the PREF instruction for all other details, including the encoding of the *hint* field.

Restrictions:

Availability and Compatibility:

Required in all versions of MIPS64 since MIPS64 Release 1. Not available in MIPS32 Release 1. Required by MIPS32 Release 2 and subsequent versions of MIPS32. When required, required whenever FPU is present, whether a 32-bit or 64-bit FPU, whether in 32-bit or 64-bit FP Register Mode (*FIR_{F64}*=0 or 1, *Status_{FR}*=0 or 1).

This instruction has been removed in Release 6.

Operation:

```
vAddr ← GPR[base] + GPR[index]
(pAddr, CCA) ← AddressTranslation(vAddr, DATA, LOAD)
Prefetch(CCA, pAddr, vAddr, DATA, hint)
```

Exceptions:

Coprocessor Unusable, Reserved Instruction, Bus Error, Cache Error

Programming Notes:

The PREFX instruction is only available on processors that implement floating point and should never be generated by compilers in situations other than those in which the corresponding load and store indexed floating point instructions are generated.

Refer to the corresponding section in the PREF instruction description.

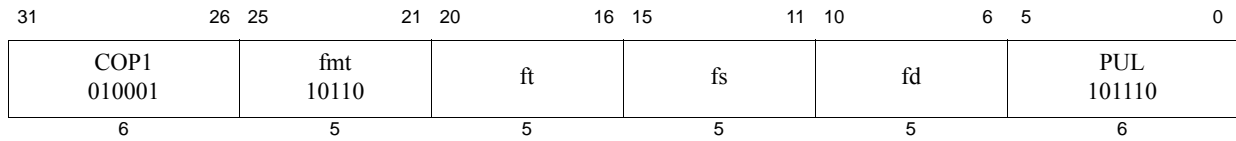

Format: PUL.PS fd, fs, ft

MIPS64, MIPS32 Release 2, removed in Release 6

Purpose: Pair Upper Lower

To merge a pair of paired single values with realignment.

Description: $FPR[fd] \leftarrow upper(FPR[fs]) \ || \ lower(FPR[ft])$

A new paired-single value is formed by concatenating the upper single of FPR *fs* (bits **63..32**) and the lower single of FPR *ft* (bits **31..0**).

The move is non-arithmetic; it causes no IEEE 754 exceptions, and the $FCSR_{Cause}$ and $FCSR_{Flags}$ fields are not modified.

Restrictions:

The fields *fs*, *ft*, and *fd* must specify FPRs valid for operands of type *PS*. If the fields are not valid, the result is **UNPREDICTABLE**.

The result of this instruction is **UNPREDICTABLE** if the processor is executing in the $FR=0$ 32-bit FPU register model. It is predictable if executing on a 64-bit FPU in the $FR=1$ mode, but not with $FR=0$, and not on a 32-bit FPU.

Availability and Compatibility:

This instruction has been removed in Release 6.

Operation:

$StoreFPR(fd, PS, ValueFPR(fs, PS)_{63..32} \ || \ ValueFPR(ft, PS)_{31..0})$

Exceptions:

Coprocessor Unusable, Reserved Instruction

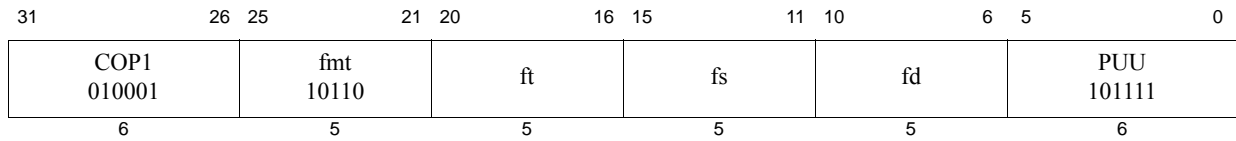

Format: PUU.PS *fd*, *fs*, *ft*

MIPS64, MIPS32 Release 2,, removed in Release 6

Purpose: Pair Upper Upper

To merge a pair of paired single values with realignment.

Description: $FPR[fd] \leftarrow upper(FPR[fs]) \ || \ upper(FPR[ft])$

A new paired-single value is formed by concatenating the upper single of FPR *fs* (bits **63..32**) and the upper single of FPR *ft* (bits **63..32**).

The move is non-arithmetic; it causes no IEEE 754 exceptions, and the $FCSR_{Cause}$ and $FCSR_{Flags}$ fields are not modified.

Restrictions:

The fields *fs*, *ft*, and *fd* must specify FPRs valid for operands of type *PS*. If the fields are not valid, the result is **UNPREDICTABLE**.

The result of this instruction is **UNPREDICTABLE** if the processor is executing in the $FR=0$ 32-bit FPU register model. It is predictable if executing on a 64-bit FPU in the $FR=1$ mode, but not with $FR=0$, and not on a 32-bit FPU.

Availability and Compatibility:

This instruction has been removed in Release 6.

Operation:

$StoreFPR(fd, PS, ValueFPR(fs, PS)_{63..32} \ || \ ValueFPR(ft, PS)_{63..32})$

Exceptions:

Coprocessor Unusable, Reserved Instruction

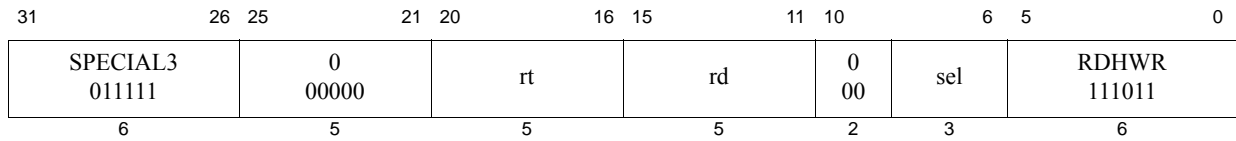

Format: RDHWR *rt, rd, sel*

MIPS32 Release 2

Purpose: Read Hardware Register

To move the contents of a hardware register to a general purpose register (GPR) if that operation is enabled by privileged software.

The purpose of this instruction is to give user mode access to specific information that is otherwise only visible in kernel mode.

In Release 6, a *sel* field has been added to allow a register with multiple instances to be read selectively. Specifically it is used for *PerfCtr*.

Description: $GPR[rt] \leftarrow HWR[rd]; GPR[rt] \leftarrow HWR[rd, sel]$

If access is allowed to the specified hardware register, the contents of the register specified by *rd* (optionally *sel* in Release 6) is loaded into general register *rt*. Access control for each register is selected by the bits in the coprocessor 0 *HWREna* register.

The available hardware registers, and the encoding of the *rd* field for each, are shown in [Table 5.4](#).

Table 5.4 RDHWR Register Numbers

Register Number (<i>rd</i> Value)	Mnemonic	Description										
0	CPUNum	Number of the CPU on which the program is currently running. This register provides read access to the coprocessor 0 <i>EBase_{CPUNum}</i> field.										
1	SYNCI_Step	Address step size to be used with the SYNCI instruction, or zero if no caches need be synchronized. See that instruction's description for the use of this value.										
2	CC	High-resolution cycle counter. This register provides read access to the coprocessor 0 <i>Count</i> Register.										
3	CCRes	Resolution of the CC register. This value denotes the number of cycles between update of the register. For example: <table border="1" style="margin-left: auto; margin-right: auto;"> <thead> <tr> <th>CCRes Value</th> <th>Meaning</th> </tr> </thead> <tbody> <tr> <td style="text-align: center;">1</td> <td>CC register increments every CPU cycle</td> </tr> <tr> <td style="text-align: center;">2</td> <td>CC register increments every second CPU cycle</td> </tr> <tr> <td style="text-align: center;">3</td> <td>CC register increments every third CPU cycle</td> </tr> <tr> <td colspan="2" style="text-align: center;">etc.</td> </tr> </tbody> </table>	CCRes Value	Meaning	1	CC register increments every CPU cycle	2	CC register increments every second CPU cycle	3	CC register increments every third CPU cycle	etc.	
CCRes Value	Meaning											
1	CC register increments every CPU cycle											
2	CC register increments every second CPU cycle											
3	CC register increments every third CPU cycle											
etc.												
4	PerfCtr	Performance Counter Pair. Even <i>sel</i> selects the <i>Control</i> register, while odd <i>sel</i> selects the <i>Counter</i> register in the pair. The value of <i>sel</i> corresponds to the value of <i>sel</i> used by MFC0 to read the COP0 register.										

Table 5.4 RDHWR Register Numbers

Register Number (rd Value)	Mnemonic	Description
5	XNP	Indicates support for the Release 6 Paired LL/SC family of instructions. If set to 1, the LL/SC family of instructions is not present, otherwise, it is present in the implementation. In absence of hardware support for double-width or extended atomics, user software may emulate the instruction's behavior through other means. See <i>Config5_{XNP}</i> .
6-28		These registers numbers are reserved for future architecture use. Access results in a Reserved Instruction Exception.
29	ULR	User Local Register. This register provides read access to the coprocessor 0 <i>UserLocal</i> register, if it is implemented. In some operating environments, the <i>UserLocal</i> register is a pointer to a thread-specific storage block.
30-31		These register numbers are reserved for implementation-dependent use. If they are not implemented, access results in a Reserved Instruction Exception.

Restrictions:

In implementations of Release 1 of the Architecture, this instruction resulted in a Reserved Instruction Exception.

Access to the specified hardware register is enabled if Coprocessor 0 is enabled, or if the corresponding bit is set in the *HWREna* register. If access is not allowed or the register is not implemented, a Reserved Instruction Exception is signaled.

In Release 6, when the 3-bit *sel* is undefined for use with a specific register number, then a Reserved Instruction Exception is signaled.

Availability and Compatibility:

This instructions has been recoded for Release 6. The instruction supports a *sel* field in Release 6.

Operation:

```

    if ((rs!=4) and (sel==0))
    case rd
        0: temp ← EBaseCPUNum
        1: temp ← SYNCI_StepSize()
        2: temp ← Count
        3: temp ← CountResolution()
            if (>=2) // #5 - Release 6
                5: temp ← Config5XNPendif
        29: temp ← UserLocal

        endif
        30: temp ← Implementation-Dependent-Value
        31: temp ← Implementation-Dependent-Value
        otherwise: SignalException(ReservedInstruction)
    endcase
    elseif ((rs==4) and (>=2) and (sel==defined)) // #4 - Release 6
        temp ← PerfCtr[sel]
    else
    endif
GPR[rt] ← temp

```

Exceptions:

Reserved Instruction

For a register that does not require *sel*, the compiler must support an assembly syntax without *sel* that is ‘RDHWR rt, rd’. Another valid syntax is for *sel* to be 0 to map to pre-Release 6 register numbers which do not require use of *sel* that is, ‘RDHWR rt, rd, 0’.

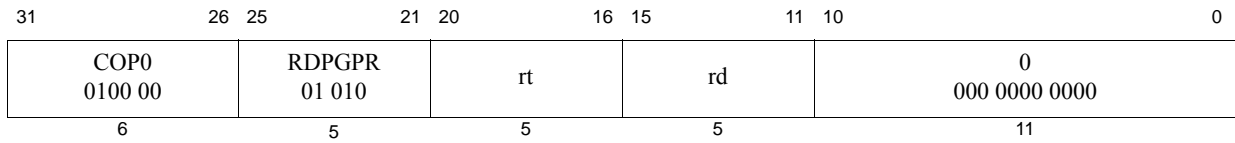

Format: RDPGPR rd, rt

MIPS32 Release 2

Purpose: Read GPR from Previous Shadow Set

To move the contents of a GPR from the previous shadow set to a current GPR.

Description: $GPR[rd] \leftarrow SGPR[SRSCtl_{pSS}, rt]$

The contents of the shadow GPR register specified by $SRSCtl_{pSS}$ (signifying the previous shadow set number) and rt (specifying the register number within that set) is moved to the current GPR rd .

Restrictions:

In implementations prior to Release 2 of the Architecture, this instruction resulted in a Reserved Instruction exception.

Operation:

$GPR[rd] \leftarrow SGPR[SRSCtl_{pSS}, rt]$

Exceptions:

Coprocessor Unusable

Reserved Instruction

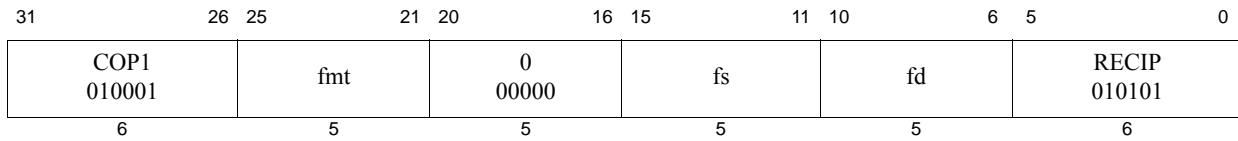

Format: RECIP.fmt
 RECIP.S fd, fs
 RECIP.D fd, fs

MIPS64, MIPS32 Release 2
 MIPS64, MIPS32 Release 2

Purpose: Reciprocal Approximation

To approximate the reciprocal of an FP value (quickly).

Description: $FPR[fd] \leftarrow 1.0 / FPR[fs]$

The reciprocal of the value in FPR *fs* is approximated and placed into FPR *fd*. The operand and result are values in format *fmt*.

The numeric accuracy of this operation is implementation dependent. It does not meet the accuracy specified by the IEEE 754 Floating Point standard. The computed result differs from the both the exact result and the IEEE-mandated representation of the exact result by no more than one unit in the least-significant place (ULP).

It is implementation dependent whether the result is affected by the current rounding mode in *FCSR*.

Restrictions:

The fields *fs* and *fd* must specify FPRs valid for operands of type *fmt*. If the fields are not valid, the result is **UNPREDICTABLE**.

The operand must be a value in format *fmt*; if it is not, the result is **UNPREDICTABLE** and the value of the operand FPR becomes **UNPREDICTABLE**.

Availability and Compatibility:

RECIP.S and RECIP.D: Required in all versions of MIPS64 since MIPS64 Release 1. Not available in MIPS32 Release 1. Required in MIPS32 Release 2 and all subsequent versions of MIPS32. When required, required whenever FPU is present, whether a 32-bit or 64-bit FPU, whether in 32-bit or 64-bit FP Register Mode ($FIR_{F64}=0$ or 1, $Status_{FR}=0$ or 1).

Operation:

$StoreFPR(fd, fmt, 1.0 / valueFPR(fs, fmt))$

Exceptions:

Coprocessor Unusable, Reserved Instruction

Floating Point Exceptions:

Inexact, Division-by-zero, Unimplemented Op, Invalid Op, Overflow, Underflow

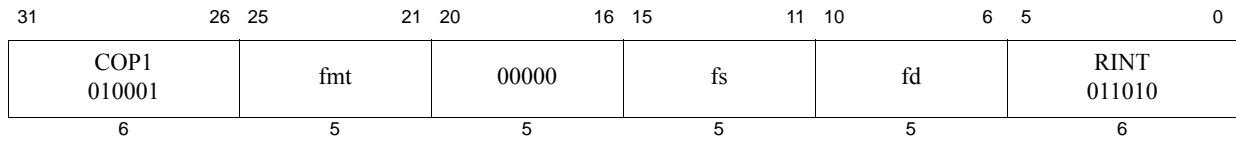

Format: RINT.fmt
 RINT.S fd, fs
 RINT.D fd, fs

MIPS32 Release 6
MIPS32 Release 6
MIPS32 Release 6

Purpose: Floating-Point Round to Integral

Scalar floating-point round to integral floating point value.

Description: $FPR[fd] \leftarrow \text{round_int}(FPR[fs])$

The scalar floating-point value in the register *fs* is rounded to an integral valued floating-point number in the same format based on the rounding mode bits *RM* in the FPU Control and Status Register *FCSR*. The result is written to *fd*.

The operands and results are values in floating-point data format *fmt*.

The RINT.fmt instruction corresponds to the **roundToIntegralExact** operation in the IEEE Standard for Floating-Point Arithmetic 754TM-2008. The Inexact exception is signaled if the result does not have the same numerical value as the input operand.

The floating point scalar instruction RINT.fmt corresponds to the MSA vector instruction FRINT.df. I.e. RINT.S corresponds to FRINT.W, and RINT.D corresponds to FRINT.D.

Restrictions:

Data-dependent exceptions are possible as specified by the IEEE Standard for Floating-Point Arithmetic 754TM-2008.

Availability and Compatibility:

This instruction is introduced by and required as of Release 6.

Operation:

RINT.fmt:

```

if not IsCoprocesorEnabled(1)
  then SignalException(CoprocesorUnusable, 1) endif
if not IsFloatingPointImplemented(fmt)
  then SignalException(ReservedInstruction) endif

fin ← ValueFPR(fs, fmt)
ftmp ← RoundIntFP(fin, fmt)
if( fin ≠ ftmp ) SignalFPEXception(InExact)
StoreFPR (fd, fmt, ftmp )

function RoundIntFP(tt, n)
  /* Round to integer operation, using rounding mode FCSR.RM*/
endfunction RoundIntFP

```

Exceptions:

Coprocesor Unusable, Reserved Instruction

Floating Point Exceptions:

Unimplemented Operation, Invalid Operation, Inexact, Overflow, Underflow

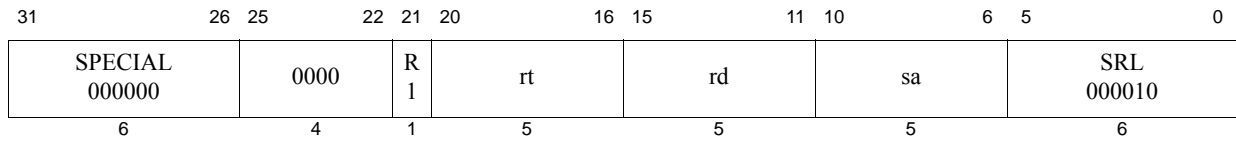

Format: ROTR *rd*, *rt*, *sa*

SmartMIPS Crypto, MIPS32 Release 2

Purpose: Rotate Word Right

To execute a logical right-rotate of a word by a fixed number of bits.

Description: $GPR[rd] \leftarrow GPR[rt] \times(\text{right}) sa$

The contents of the low-order 32-bit word of GPR *rt* are rotated right; the word result is placed in GPR *rd*. The bit-rotate amount is specified by *sa*.

Restrictions:

Operation:

```

if ((ArchitectureRevision() < 2) and (Config3SM = 0)) then
  UNPREDICTABLE
endif
s ← sa
temp ← GPR[rt]s-1..0 || GPR[rt]31..s
GPR[rd] ← temp

```

Exceptions:

Reserved Instruction

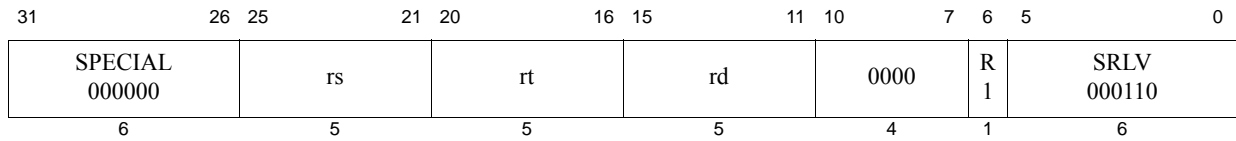

Format: ROTRV *rd*, *rt*, *rs*

SmartMIPS Crypto, MIPS32 Release 2

Purpose: Rotate Word Right Variable

To execute a logical right-rotate of a word by a variable number of bits.

Description: $GPR[rd] \leftarrow GPR[rt] \times(\text{right}) GPR[rs]$

The contents of the low-order 32-bit word of GPR *rt* are rotated right; the word result is placed in GPR *rd*. The bit-rotate amount is specified by the low-order 5 bits of GPR *rs*.

Restrictions:

Operation:

```

if ((ArchitectureRevision() < 2) and (Config3SM = 0)) then
  UNPREDICTABLE
endif
s ← GPR[rs]4..0
temp ← GPR[rt]s-1..0 || GPR[rt]31..s
GPR[rd] ← temp

```

Exceptions:

Reserved Instruction

31	26 25	21 20	16 15	11 10	6 5	0
COP1 010001	fmt	0 00000	fs	fd	ROUND.L 001000	
6	5	5	5	5	6	

Format: ROUND.L.fmt
 ROUND.L.S fd, fs
 ROUND.L.D fd, fs

MIPS64,MIPS32 Release 2
MIPS64,MIPS32 Release 2

Purpose: Floating Point Round to Long Fixed Point

To convert an FP value to 64-bit fixed point, rounding to nearest.

Description: $FPR[fd] \leftarrow \text{convert_and_round}(FPR[fs])$

The value in FPR *fs*, in format *fmt*, is converted to a value in 64-bit long fixed point format and rounded to nearest/even (rounding mode 0). The result is placed in FPR *fd*.

When the source value is Infinity, NaN, or rounds to an integer outside the range -2^{63} to $2^{63}-1$, the result cannot be represented correctly and an IEEE Invalid Operation condition exists. The Invalid Operation flag is set in the *FCSR*. If the Invalid Operation *Enable* bit is set in the *FCSR*, no result is written to *fd* and an Invalid Operation exception is taken immediately. Otherwise, a default result is written to *fd*. On cores with $FCSR_{NAN2008}=0$, the default result is $2^{63}-1$. On cores with $FCSR_{NAN2008}=1$, the default result is:

- 0 when the input value is NaN
- $2^{63}-1$ when the input value is $+\infty$ or rounds to a number larger than $2^{63}-1$
- $-2^{63}-1$ when the input value is $-\infty$ or rounds to a number smaller than $-2^{63}-1$

Restrictions:

The fields *fs* and *fd* must specify valid FPRs: *fs* for type *fmt* and *fd* for long fixed point. If the fields are not valid, the result is **UNPREDICTABLE**.

The operand must be a value in format *fmt*; if it is not, the result is **UNPREDICTABLE** and the value of the operand FPR becomes **UNPREDICTABLE**.

The result of this instruction is **UNPREDICTABLE** if the processor is executing in the *FR=0* 32-bit FPU register model. It is predictable if executing on a 64-bit FPU in the *FR=1* mode, but not with *FR=0*, and not on a 32-bit FPU.

Operation:

$\text{StoreFPR}(fd, L, \text{ConvertFmt}(\text{ValueFPR}(fs, fmt), fmt, L))$

Exceptions:

Coprocessor Unusable, Reserved Instruction

Floating Point Exceptions:

Inexact, Unimplemented Operation, Invalid Operation

31	26 25	21 20	16 15	11 10	6 5	0
COP1 010001	fmt	0 00000	fs	fd	ROUND.W 001100	
6	5	5	5	5	6	

Format: ROUND.W.fmt

ROUND.W.S fd, fs

ROUND.W.D fd, fs

MIPS32

MIPS32

Purpose: Floating Point Round to Word Fixed Point

To convert an FP value to 32-bit fixed point, rounding to nearest.

Description: $FPR[fd] \leftarrow \text{convert_and_round}(FPR[fs])$

The value in FPR *fs*, in format *fmt*, is converted to a value in 32-bit word fixed point format rounding to nearest/even (rounding mode 0). The result is placed in FPR *fd*.

When the source value is Infinity, NaN, or rounds to an integer outside the range -2^{31} to $2^{31}-1$, the result cannot be represented correctly and an IEEE Invalid Operation condition exists. The Invalid Operation flag is set in the *FCSR*. If the Invalid Operation *Enable* bit is set in the *FCSR*, no result is written to *fd* and an Invalid Operation exception is taken immediately. Otherwise, a default result is written to *fd*. On cores with $FCSR_{NAN2008}=0$, the default result is $2^{31}-1$. On cores with $FCSR_{NAN2008}=1$, the default result is:

- 0 when the input value is NaN
- $2^{31}-1$ when the input value is $+\infty$ or rounds to a number larger than $2^{31}-1$
- $-2^{31}-1$ when the input value is $-\infty$ or rounds to a number smaller than $-2^{31}-1$

Restrictions:

The fields *fs* and *fd* must specify valid FPRs: *fs* for type *fmt* and *fd* for word fixed point. If the fields are not valid, the result is **UNPREDICTABLE**.

The operand must be a value in format *fmt*; if it is not, the result is **UNPREDICTABLE** and the value of the operand FPR becomes **UNPREDICTABLE**.

Operation:

`StoreFPR(fd, W, ConvertFmt(ValueFPR(fs, fmt), fmt, W))`

Exceptions:

Coprocessor Unusable, Reserved Instruction

Floating Point Exceptions:

Inexact, Unimplemented Operation, Invalid Operation

31	26 25	21 20	16 15	11 10	6 5	0
COP1 010001	fmt	0 00000	fs	fd	RSQRT 010110	
6	5	5	5	5	6	

Format: RSQRT.fmt
 RSQRT.S fd, fs
 RSQRT.D fd, fs

MIPS64, MIPS32 Release 2
MIPS64, MIPS32 Release 2

Purpose: Reciprocal Square Root Approximation

To approximate the reciprocal of the square root of an FP value (quickly).

Description: $FPR[fd] \leftarrow 1.0 / \text{sqrt}(FPR[fs])$

The reciprocal of the positive square root of the value in FPR *fs* is approximated and placed into FPR *fd*. The operand and result are values in format *fmt*.

The numeric accuracy of this operation is implementation dependent; it does not meet the accuracy specified by the IEEE 754 Floating Point standard. The computed result differs from both the exact result and the IEEE-mandated representation of the exact result by no more than two units in the least-significant place (ULP).

The effect of the current *FCSR* rounding mode on the result is implementation dependent.

Restrictions:

The fields *fs* and *fd* must specify FPRs valid for operands of type *fmt*. If the fields are not valid, the result is **UNPREDICTABLE**.

The operand must be a value in format *fmt*; if it is not, the result is **UNPREDICTABLE** and the value of the operand FPR becomes **UNPREDICTABLE**.

Availability and Compatibility:

RSQRT.S and RSQRT.D: Required in all versions of MIPS64 since MIPS64 Release 1. Not available in MIPS32 Release 1. Required in MIPS32 Release 2 and all subsequent versions of MIPS32. When required, required whenever FPU is present, whether a 32-bit or 64-bit FPU, whether in 32-bit or 64-bit FP Register Mode ($FIR_{F64}=0$ or 1, $Status_{FR}=0$ or 1).

Operation:

`StoreFPR(fd, fmt, 1.0 / SquareRoot(valueFPR(fs, fmt)))`

Exceptions:

Coprocessor Unusable, Reserved Instruction

Floating Point Exceptions:

Inexact, Division-by-zero, Unimplemented Operation, Invalid Operation, Overflow, Underflow

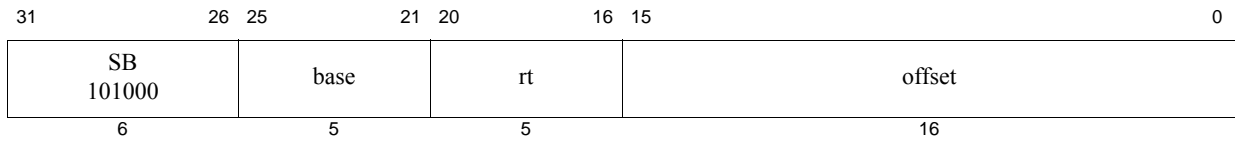

Format: SB *rt*, *offset*(*base*)

MIPS32

Purpose: Store Byte

To store a byte to memory.

Description: $\text{memory}[\text{GPR}[\text{base}] + \text{offset}] \leftarrow \text{GPR}[\text{rt}]$

The least-significant 8-bit byte of GPR *rt* is stored in memory at the location specified by the effective address. The 16-bit signed *offset* is added to the contents of GPR *base* to form the effective address.

Restrictions:

None

Operation:

```

vAddr ← sign_extend(offset) + GPR[base]
(pAddr, CCA) ← AddressTranslation (vAddr, DATA, STORE)
pAddr ← pAddr_PSIZE-1..2 || (pAddr_1..0 xor ReverseEndian2)
bytesel ← vAddr_1..0 xor BigEndianCPU2
dataword ← GPR[rt]_31-8*bytesel..0 || 08*bytesel
StoreMemory (CCA, BYTE, dataword, pAddr, vAddr, DATA)

```

Exceptions:

TLB Refill, TLB Invalid, TLB Modified, Bus Error, Address Error, Watch

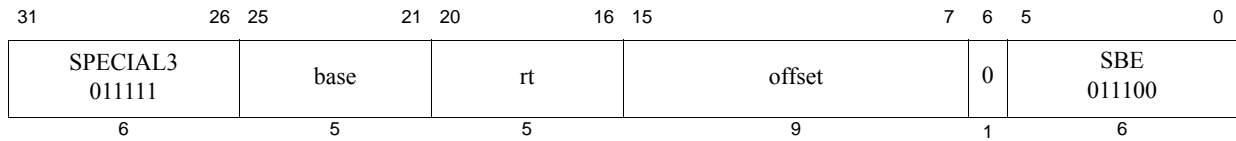

Format: SBE *rt*, *offset*(*base*)

MIPS32

Purpose: Store Byte EVA

To store a byte to user mode virtual address space when executing in kernel mode.

Description: $\text{memory}[\text{GPR}[\text{base}] + \text{offset}] \leftarrow \text{GPR}[\text{rt}]$

The least-significant 8-bit byte of GPR *rt* is stored in memory at the location specified by the effective address. The 9-bit signed *offset* is added to the contents of GPR *base* to form the effective address.

The SBE instruction functions the same as the SB instruction, except that address translation is performed using the user mode virtual address space mapping in the TLB when accessing an address within a memory segment configured to use the MUSUK access mode. Memory segments using UUSK or MUSK access modes are also accessible. Refer to Volume III, Enhanced Virtual Addressing section for additional information.

Implementation of this instruction is specified by the *Config5_{EVA}* field being set to 1.

Restrictions:

Only usable when access to Coprocessor0 is enabled and when accessing an address within a segment configured using UUSK, MUSK or MUSUK access mode.

Operation:

```
vAddr ← sign_extend(offset) + GPR[base]
(pAddr, CCA) ← AddressTranslation(vAddr, DATA, STORE)
pAddr ← pAddrPSIZE-1..2 || (pAddr1..0 xor ReverseEndian2)
bytesel ← vAddr1..0 xor BigEndianCPU2
dataword ← GPR[rt]31-8*bytesel..0 || 08*bytesel
StoreMemory(CCA, BYTE, dataword, pAddr, vAddr, DATA)
```

Exceptions:

TLB Refill, TLB Invalid, Bus Error, Address Error, Watch, Reserved Instruction, Coprocessor Unusable,

pre-Release 6

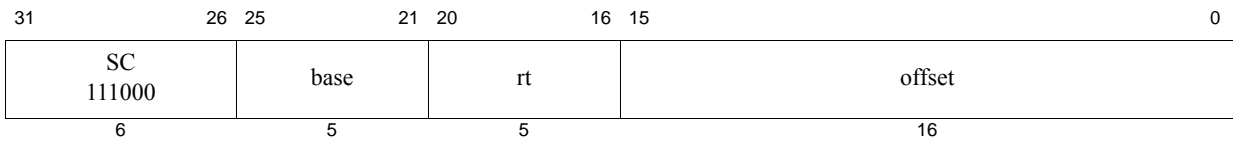

Release 6

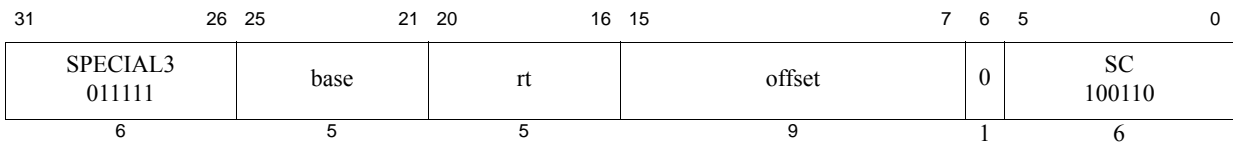
**Format:** SC *rt*, *offset*(*base*)**MIPS32****Purpose:** Store Conditional Word

To store a word to memory to complete an atomic read-modify-write

Description: if `atomic_update` then `memory[GPR[base] + offset] ← GPR[rt]`, `GPR[rt] ← 1`
else `GPR[rt] ← 0`The LL and SC instructions provide primitives to implement atomic read-modify-write (RMW) operations on synchronizable memory locations. In Release 5, the behavior of SC is modified when `Config5LLB=1`.The 32-bit word in GPR *rt* is conditionally stored in memory at the location specified by the aligned effective address. The signed *offset* is added to the contents of GPR *base* to form an effective address.

The SC completes the RMW sequence begun by the preceding LL instruction executed on the processor. To complete the RMW sequence atomically, the following occur:

- The 32-bit word of GPR *rt* is stored to memory at the location specified by the aligned effective address.
- A one, indicating success, is written into GPR *rt*.

Otherwise, memory is not modified and a 0, indicating failure, is written into GPR *rt*.

If either of the following events occurs between the execution of LL and SC, the SC fails:

- A coherent store is completed by another processor or coherent I/O module into the block of synchronizable physical memory containing the word. The size and alignment of the block is implementation-dependent, but it is at least one word and at most the minimum page size.
- A coherent store is executed between an LL and SC sequence on the same processor to the block of synchronizable physical memory containing the word (if `Config5LLB=1`; else whether such a store causes the SC to fail is not predictable).
- An ERET instruction is executed. (Release 5 includes ERETNC, which will not cause the SC to fail.)

Furthermore, an SC must always compare its address against that of the LL. An SC will fail if the aligned address of the SC does not match that of the preceding LL.

A load that executes on the processor executing the LL/SC sequence to the block of synchronizable physical memory containing the word, will not cause the SC to fail (if `Config5LLB=1`; else such a load may cause the SC to fail).

If any of the events listed below occurs between the execution of LL and SC, the SC may fail where it could have succeeded, i.e., success is not predictable. Portable programs should not cause any of these events.

- A load or store executed on the processor executing the LL and SC that is not to the block of synchronizable physical memory containing the word. (The load or store may cause a cache eviction between the LL and SC that results in SC failure. The load or store does not necessarily have to occur between the LL and SC.)
- Any prefetch that is executed on the processor executing the LL and SC sequence (due to a cache eviction between the LL and SC).
- A non-coherent store executed between an LL and SC sequence to the block of synchronizable physical memory containing the word.
- The instructions executed starting with the LL and ending with the SC do not lie in a 2048-byte contiguous region of virtual memory. (The region does not have to be aligned, other than the alignment required for instruction words.)

CACHE operations that are local to the processor executing the LL/SC sequence will result in unpredictable behaviour of the SC if executed between the LL and SC, that is, they may cause the SC to fail where it could have succeeded. Non-local CACHE operations (address-type with coherent CCA) may cause an SC to fail on either the local processor or on the remote processor in multiprocessor or multi-threaded systems. This definition of the effects of CACHE operations is mandated if *Config5_{LLB}*=1. If *Config5_{LLB}*=0, then CACHE effects are implementation-dependent.

The following conditions must be true or the result of the SC is not predictable—the SC may fail or succeed (if *Config5_{LLB}*=1, then either success or failure is mandated, else the result is **UNPREDICTABLE**):

- Execution of SC must have been preceded by execution of an LL instruction.
- An RMW sequence executed without intervening events that would cause the SC to fail must use the same address in the LL and SC. The address is the *same* if the virtual address, physical address, and cacheability & coherency attribute are identical.

Atomic RMW is provided only for synchronizable memory locations. A synchronizable memory location is one that is associated with the state and logic necessary to implement the LL/SC semantics. Whether a memory location is synchronizable depends on the processor and system configurations, and on the memory access type used for the location:

- **Uniprocessor atomicity:** To provide atomic RMW on a single processor, all accesses to the location must be made with memory access type of either *cached noncoherent* or *cached coherent*. All accesses must be to one or the other access type, and they may not be mixed.
- **MP atomicity:** To provide atomic RMW among multiple processors, all accesses to the location must be made with a memory access type of *cached coherent*.
- **I/O System:** To provide atomic RMW with a coherent I/O system, all accesses to the location must be made with a memory access type of *cached coherent*. If the I/O system does not use coherent memory operations, then atomic RMW cannot be provided with respect to the I/O reads and writes.

Restrictions:

The addressed location must have a memory access type of *cached noncoherent* or *cached coherent*; if it does not, the result is **UNPREDICTABLE**.

The effective address must be naturally-aligned. If either of the 2 least-significant bits of the address is non-zero, an Address Error exception occurs.

Providing misaligned support for Release 6 is not a requirement for this instruction.

Availability and Compatibility

This instruction has been recoded for Release 6.

Operation:

```

vAddr ← sign_extend(offset) + GPR[base]
if vAddr1..0 ≠ 02 then
    SignalException(AddressError)
endif
(pAddr, CCA) ← AddressTranslation (vAddr, DATA, STORE)
dataword ← GPR[rt]
if LLbit then
    StoreMemory (CCA, WORD, dataword, pAddr, vAddr, DATA)
endif
GPR[rt] ← 031 || LLbit
LLbit ← 0 // if Config5LLB=1, SC always clears LLbit regardless of address match.

```

Exceptions:

TLB Refill, TLB Invalid, TLB Modified, Address Error, Watch

Programming Notes:

LL and SC are used to atomically update memory locations, as shown below.

```

L1:
    LL    T1, (T0) # load counter
    ADDI  T2, T1, 1 # increment
    SC    T2, (T0) # try to store, checking for atomicity
    BEQ   T2, 0, L1 # if not atomic (0), try again
    NOP                   # branch-delay slot

```

Exceptions between the LL and SC cause SC to fail, so persistent exceptions must be avoided. Some examples of these are arithmetic operations that trap, system calls, and floating point operations that trap or require software emulation assistance.

LL and SC function on a single processor for *cached noncoherent* memory so that parallel programs can be run on uniprocessor systems that do not support *cached coherent* memory access types.

As shown in the instruction drawing above, Release 6 implements a 9-bit offset, whereas all release levels lower than Release 6 of the MIPS architecture implement a 16-bit offset.

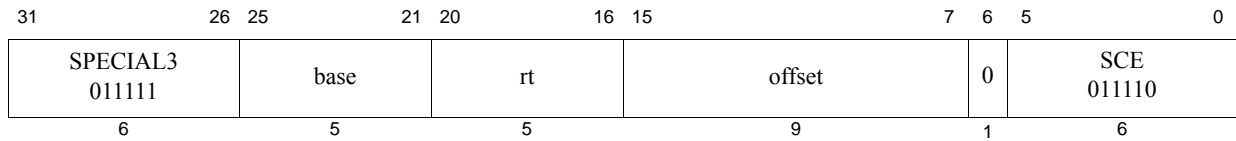

Format: SCE *rt*, *offset*(*base*)

MIPS32

Purpose: Store Conditional Word EVA

To store a word to user mode virtual memory while operating in kernel mode to complete an atomic read-modify-write.

Description: if `atomic_update` then `memory[GPR[base] + offset] ← GPR[rt]`, `GPR[rt] ← 1` else `GPR[rt] ← 0`

The LL and SC instructions provide primitives to implement atomic read-modify-write (RMW) operations for synchronizable memory locations.

The 32-bit word in GPR *rt* is conditionally stored in memory at the location specified by the aligned effective address. The 9-bit signed *offset* is added to the contents of GPR *base* to form an effective address.

The SCE completes the RMW sequence begun by the preceding LLE instruction executed on the processor. To complete the RMW sequence atomically, the following occurs:

- The 32-bit word of GPR *rt* is stored to memory at the location specified by the aligned effective address.
- A 1, indicating success, is written into GPR *rt*.

Otherwise, memory is not modified and a 0, indicating failure, is written into GPR *rt*.

If either of the following events occurs between the execution of LL and SC, the SC fails:

- A coherent store is completed by another processor or coherent I/O module into the block of synchronizable physical memory containing the word. The size and alignment of the block is implementation dependent, but it is at least one word and at most the minimum page size.
- An ERET instruction is executed.

If either of the following events occurs between the execution of LLE and SCE, the SCE may succeed or it may fail; the success or failure is not predictable. Portable programs should not cause one of these events.

- A memory access instruction (load, store, or prefetch) is executed on the processor executing the LLE/SCE.
- The instructions executed starting with the LLE and ending with the SCE do not lie in a 2048-byte contiguous region of virtual memory. (The region does not have to be aligned, other than the alignment required for instruction words.)

The following conditions must be true or the result of the SCE is **UNPREDICTABLE**:

- Execution of SCE must have been preceded by execution of an LLE instruction.
- An RMW sequence executed without intervening events that would cause the SCE to fail must use the same address in the LLE and SCE. The address is the same if the virtual address, physical address, and cacheability & coherency attribute are identical.

Atomic RMW is provided only for synchronizable memory locations. A synchronizable memory location is one that is associated with the state and logic necessary to implement the LLE/SCE semantics. Whether a memory location is synchronizable depends on the processor and system configurations, and on the memory access type used for the location:

- **Uniprocessor atomicity:** To provide atomic RMW on a single processor, all accesses to the location must be made with memory access type of either *cached non coherent* or *cached coherent*. All accesses must be to one or the other access type, and they may not be mixed.
- **MP atomicity:** To provide atomic RMW among multiple processors, all accesses to the location must be made with a memory access type of *cached coherent*.
- **I/O System:** To provide atomic RMW with a coherent I/O system, all accesses to the location must be made with a memory access type of *cached coherent*. If the I/O system does not use coherent memory operations, then atomic RMW cannot be provided with respect to the I/O reads and writes.

The SCE instruction functions the same as the SC instruction, except that address translation is performed using the user mode virtual address space mapping in the TLB when accessing an address within a memory segment configured to use the MUSUK access mode. Memory segments using UUSK or MUSK access modes are also accessible. Refer to Volume III, Enhanced Virtual Addressing section for additional information.

Implementation of this instruction is specified by the *Config5_{EVA}* field being set to 1.

Restrictions:

The addressed location must have a memory access type of *cached non coherent* or *cached coherent*; if it does not, the result is **UNPREDICTABLE**.

The effective address must be naturally-aligned. If either of the 2 least-significant bits of the address is non-zero, an Address Error exception occurs.

Providing misaligned support for Release 6 is not a requirement for this instruction.

Operation:

```
vAddr ← sign_extend(offset) + GPR[base]
if vAddr1..0 ≠ 02 then
    SignalException(AddressError)
endif
(pAddr, CCA) ← AddressTranslation (vAddr, DATA, STORE)
dataword ← GPR[rt]
if LLbit then
    StoreMemory (CCA, WORD, dataword, pAddr, vAddr, DATA)
endif
GPR[rt] ← 031 || LLbit
```

Exceptions:

TLB Refill, TLB Invalid, TLB Modified, Address Error, Watch, Reserved Instruction, Coprocessor Unusable

Programming Notes:

LLE and SCE are used to atomically update memory locations, as shown below.

```
L1:
LLE    T1, (T0) # load counter
ADDI   T2, T1, 1 # increment
SCE    T2, (T0) # try to store, checking for atomicity
BEQ    T2, 0, L1 # if not atomic (0), try again
NOP                                # branch-delay slot
```

Exceptions between the LLE and SCE cause SCE to fail, so persistent exceptions must be avoided. Examples are arithmetic operations that trap, system calls, and floating point operations that trap or require software emulation assistance.

LLE and SCE function on a single processor for *cached non coherent* memory so that parallel programs can be run on uniprocessor systems that do not support *cached coherent* memory access types.

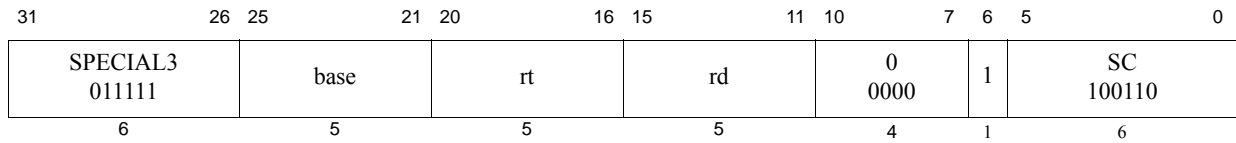

Format: SCWP *rt*, *rd*, (*base*)

MIPS32 Release 6

Purpose: Store Conditional Word Paired

Conditionally store a paired word to memory to complete an atomic read-modify-write.

Description: if `atomic_update` then `memory[GPR[base]] ← {GPR[rd],GPR[rt]}`, `GPR[rt] ← 1`
else `GPR[rt] ← 0`

The LLWP and SCWP instructions provide primitives to implement a paired word atomic read-modify-write (RMW) operation at a synchronizable memory location.

A paired word is formed from the concatenation of GPR *rd* and GPR *rt*. GPR *rd* is the most-significant word of the paired word, and GPR *rt* is the least-significant word of the paired word. The paired word is conditionally stored in memory at the location specified by the double-word aligned effective address from GPR *base*.

A paired word read or write occurs as a pair of word reads or writes that is double-word atomic.

The instruction has no offset. The effective address is equal to the contents of GPR *base*.

The SCWP completes the RMW sequence begun by the preceding LLWP instruction executed on the processor. To complete the RMW sequence atomically, the following occur:

- The paired word formed from the concatenation of GPRs *rd* and *rt* is stored to memory at the location specified by the double-word aligned effective address.
- A one, indicating success, is written into GPR *rt*.

Otherwise, memory is not modified and a 0, indicating failure, is written into GPR *rt*.

Though legal programming requires LLWP to start the atomic read-modify-write sequence and SCWP to end the same sequence, whether the SCWP completes is only dependent on the state of LLbit and *LLAddr*, which are set by a preceding load-linked instruction of any type. Software must assume that pairing load-linked and store-conditional instructions in an inconsistent manner causes **UNPREDICTABLE** behavior.

The SCWP must always compare its double-word aligned address against that of the preceding LLWP. The SCWP will fail if the address does not match that of the preceding LLWP.

Events that occur between the execution of load-linked and store-conditional instruction types that must cause the sequence to fail are given in the legacy SC instruction definition..

Additional events that occur between the execution of load-linked and store-conditional instruction types that *may* cause success of the sequence to be **UNPREDICTABLE** are defined in the SC instruction definition.

A load that executes on the processor executing the LLWP/SCWP sequence to the block of synchronizable physical memory containing the paired word, will not cause the SCWP to fail.

Effect of CACHE operations, both local and remote, on a paired word atomic operation are defined in the SC instruction definition.

Atomic RMW is provided only for synchronizable memory locations. A synchronizable memory location is one that is associated with the state and logic necessary to implement the LL/SC semantics. Whether a memory location is synchronizable depends on the processor and system configurations, and on the memory access type used for the location. Requirements for Uniprocessor, MP and I/O atomicity are given in the SC definition.

Restrictions:

Load-Linked and Store-Conditional instruction types *require* that the addressed location must have a memory access type of *cached noncoherent* or *cached coherent*, that is the processor must have a cache. If it does not, the result is **UNPREDICTABLE**.

The architecture optionally allows support for Load-Linked and Store-Conditional instruction types in a cacheless processor. Support for cacheless operation is implementation dependent. In this case, *LLAddr* is optional.

Providing misaligned support is not a requirement for this instruction.

Availability and Compatibility

This instruction is introduced by Release 6. It is only present if `Config5XNP=0`.

Operation:

```
vAddr ← GPR[base]
(pAddr, CCA) ← AddressTranslation (vAddr, DATA, STORE)
datadoubleword31..0 ← GPR[rt]
datadoubleword63..32 ← GPR[rd]
if (LLbit && (pAddr == LLAddr))then
  // PAIREDWORD: two word data-type that is double-word atomic
  StoreMemory (CCA, PAIREDWORD, datadoubleword, pAddr, vAddr, DATA)
  GPR[rt] ← 031 || 1'b1
else
  GPR[rt] ← 032
endif
LLbit ← 0
```

Exceptions:

TLB Refill, TLB Invalid, TLB Modified, Reserved Instruction, Address Error, Watch

Programming Notes:

LLWP and SCWP are used to atomically update memory locations, as shown below.

```
L1:
  LLWP  T2, T3, (T0)  # load T2 and T3
  BOVC  T2, 1, U32   # check whether least-significant word may overflow
  ADDI  T2, T2, 1    # increment lower - only
  SCWP  T2, T3, (T0) # store T2 and T3
  BEQC  T2, 0, L1    # if not atomic (0), try again

U32:
  ADDI  T2, T2, 1    # increment lower
  ADDI  T3, T3, 1    # increment upper
  SCWP  T2, T3, (T0)
  BEQC  T2, 0, L1    # if not atomic (0), try again
```

Exceptions between the LLWP and SCWP cause SC to fail, so persistent exceptions must be avoided. Some examples of these are arithmetic operations that trap, system calls, and floating point operations that trap or require software emulation assistance.

LLWP and SCWP function on a single processor for *cached noncoherent* memory so that parallel programs can be run on uniprocessor systems that do not support *cached coherent* memory access types.

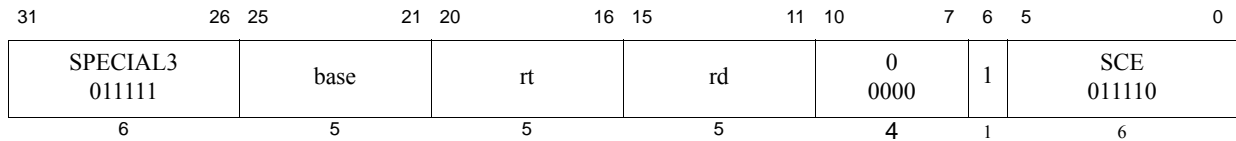

Format: SCWPE *rt*, *rd*, (*base*)

MIPS32 Release 6

Purpose: Store Conditional Word Paired EVA

Conditionally store a paired word to memory to complete an atomic read-modify-write. The store occurs in kernel mode to user virtual address space.

Description: if atomic_update then memory[GPR[base]] ← {GPR[rd], GPR[rt]}, GPR[rt] ← 1
else GPR[rt] ← 0

The LLWPE and SCWPE instructions provide primitives to implement a paired word atomic read-modify-write (RMW) operation at a synchronizable memory location.

A paired word is formed from the concatenation of GPR *rd* and GPR *rt*. GPR *rd* is the most-significant word of the double-word, and GPR *rt* is the least-significant word of the double-word. The paired word is conditionally stored in memory at the location specified by the double-word aligned effective address from GPR *base*.

A paired word read or write occurs as a pair of word reads or writes that is double-word atomic.

The instruction has no offset. The effective address is equal to the contents of GPR *base*.

The SCWPE completes the RMW sequence begun by the preceding LLWPE instruction executed on the processor. To complete the RMW sequence atomically, the following occur:

- The paired word formed from the concatenation of GPRs *rd* and *rt* is stored to memory at the location specified by the double-word aligned effective address.
- A one, indicating success, is written into GPR *rt*.

Otherwise, memory is not modified and a 0, indicating failure, is written into GPR *rt*.

Though legal programming requires LLWPE to start the atomic read-modify-write sequence and SCWPE to end the same sequence, whether the SCWPE completes is only dependent on the state of LLbit and *LLAddr*, which are set by a preceding load-linked instruction of any type. Software must assume that pairing load-linked and store-conditional instructions in an inconsistent manner causes **UNPREDICTABLE** behavior.

The SCWPE must always compare its double-word aligned address against that of the preceding LLWPE. The SCWPE will fail if the address does not match that of the preceding LLWPE.

The SCWPE instruction functions the same as the SCWP instruction, except that address translation is performed using the user mode virtual address space mapping in the TLB when accessing an address within a memory segment configured to use the MUSUK access mode. Memory segments using UUSK or MUSK access modes are also accessible. Refer to Volume III, Segmentation Control for additional information.

Events that occur between the execution of load-linked and store-conditional instruction types that must cause the sequence to fail are given in the legacy SC instruction definition..

Additional events that occur between the execution of load-linked and store-conditional instruction types that *may* cause success of the sequence to be **UNPREDICTABLE** are defined in the SC instruction definition.

A load that executes on the processor executing the LLWPE/SCWPE sequence to the block of synchronizable physical memory containing the paired word, will not cause the SCWPE to fail.

Effect of CACHE operations, both local and remote, on a paired word atomic operation are defined in the SC instruction definition.

Atomic RMW is provided only for synchronizable memory locations. A synchronizable memory location is one that is associated with the state and logic necessary to implement the LL/SC semantics. Whether a memory location is synchronizable depends on the processor and system configurations, and on the memory access type used for the location. Requirements for Uniprocessor, MP and I/O atomicity are given in the SC definition.

Restrictions:

Load-Linked and Store-Conditional instruction types *require* that the addressed location must have a memory access type of *cached noncoherent* or *cached coherent*, that is the processor must have a cache. If it does not, the result is **UNPREDICTABLE**.

The architecture optionally allows support for Load-Linked and Store-Conditional instruction types in a cacheless processor. Support for cacheless operation is implementation dependent. In this case, *LLAddr* is optional.

Providing misaligned support is not a requirement for this instruction.

Availability and Compatibility

This instruction is introduced by Release 6. It is only present if *Config5_{XNP}*=0 and *Config5_{EVA}*=1.

Operation:

```
vAddr ← GPR[base]
(pAddr, CCA) ← AddressTranslation (vAddr, DATA, STORE)
datadoubleword31..0 ← GPR[rt]
datadoubleword63..32 ← GPR[rd]
if (LLbit && (pAddr == LLAddr))then
    // PAIREDWORD: two word data-type that is double-word atomic
    StoreMemory (CCA, PAIREDWORD, datadoubleword, pAddr, vAddr, DATA)
    GPR[rt] ← 031 || 1'b1
else
    GPR[rt] ← 032
endif
LLbit ← 0
```

Exceptions:

TLB Refill, TLB Invalid, TLB Modified, Reserved Instruction, Address Error, Watch, Coprocessor Unusable.

Programming Notes:

LLWPE and SCWPE are used to atomically update memory locations, as shown below.

```
L1:
    LLWPE T2, T3, (T0) # load T2 and T3
    BOVC T2, 1, U32 # check whether least-significant word may overflow
    ADDI T2, T2, 1 # increment lower - only
    SCWPE T2, T3, (T0) # store T2 and T3
    BEQC T2, 0, L1 # if not atomic (0), try again

U32:
    ADDI T2, T2, 1 # increment lower
    ADDI T3, T3, 1 # increment upper
    SCWPE T2, T3, (T0)
    BEQC T2, 0, L1 # if not atomic (0), try again
```

Exceptions between the LLWPE and SCWPE cause SC to fail, so persistent exceptions must be avoided. Some examples of these are arithmetic operations that trap, system calls, and floating point operations that trap or require software emulation assistance.

LLWPE and SCWPE function on a single processor for *cached noncoherent* memory so that parallel programs can be run on uniprocessor systems that do not support *cached coherent* memory access types.

pre-Release 6

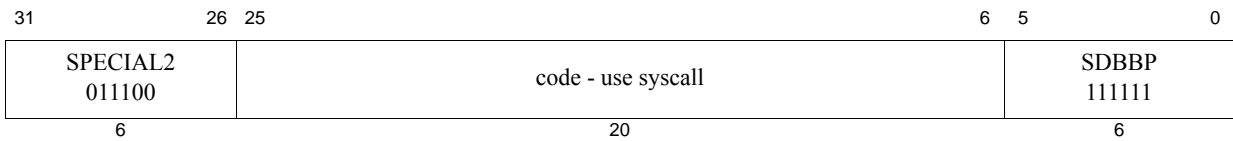

Release 6

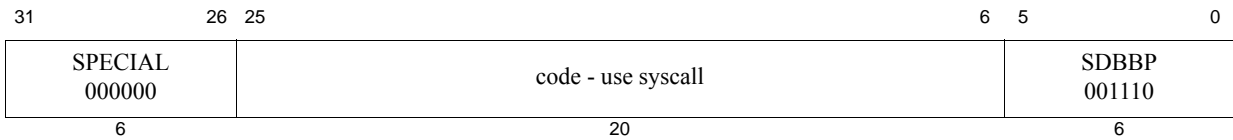
**Format:** SDBBP code**EJTAG****Purpose:** Software Debug Breakpoint

To cause a debug breakpoint exception

Description:

This instruction causes a debug exception, passing control to the debug exception handler. If the processor is executing in Debug Mode when the SDBBP instruction is executed, the exception is a Debug Mode Exception, which sets the `Debug_DExcCode` field to the value 0x9 (Bp). The code field can be used for passing information to the debug exception handler, and is retrieved by the debug exception handler only by loading the contents of the memory word containing the instruction, using the DEPC register. The CODE field is not used in any way by the hardware.

Restrictions:**Availability and Compatibility:**

This instruction has been recoded for Release 6.

Operation:

```
if Config5.SBRI=1 then /* SBRI is a MIPS Release 6 feature */
    SignalException(ReservedInstruction) endif
If Debug_DM = 1 then SignalDebugModeBreakpointException() endif // nested
SignalDebugBreakpointException() // normal
```

Exceptions:

Debug Breakpoint Exception
Debug Mode Breakpoint Exception

Programming Notes:

Release 6 changes the instruction encoding. The primary opcode changes from SPECIAL2 to SPECIAL. Also it defines a different function field value for SDBBP.

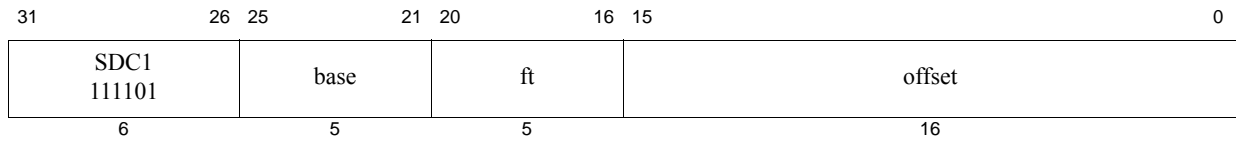

Format: SDC1 ft, offset(base)

MIPS32

Purpose: Store Doubleword from Floating Point

To store a doubleword from an FPR to memory.

Description: $\text{memory}[\text{GPR}[\text{base}] + \text{offset}] \leftarrow \text{FPR}[\text{ft}]$

The 64-bit doubleword in FPR *ft* is stored in memory at the location specified by the aligned effective address. The 16-bit signed *offset* is added to the contents of GPR *base* to form the effective address.

Restrictions:

Pre-Release 6: An Address Error exception occurs if $\text{EffectiveAddress}_{2..0} \neq 0$ (not doubleword-aligned).

Release 6 allows hardware to provide address misalignment support in lieu of requiring natural alignment.

Note: The pseudocode is not completely adapted for Release 6 misalignment support as the handling is implementation dependent.

Operation:

```

vAddr ← sign_extend(offset) + GPR[base]
(pAddr, CCA) ← AddressTranslation(vAddr, DATA, STORE)
datadoubleword ← ValueFPR(ft, UNINTERPRETED_DOUBLEWORD)
paddr ← paddr xor ((BigEndianCPU xor ReverseEndian) || 02)
StoreMemory(CCA, WORD, datadoubleword31..0, pAddr, vAddr, DATA)
paddr ← paddr xor 0b100
StoreMemory(CCA, WORD, datadoubleword63..32, pAddr, vAddr+4, DATA)

```

Exceptions:

Coprocessor Unusable, Reserved Instruction, TLB Refill, TLB Invalid, TLB Modified, Address Error, Watch

pre-Release 6

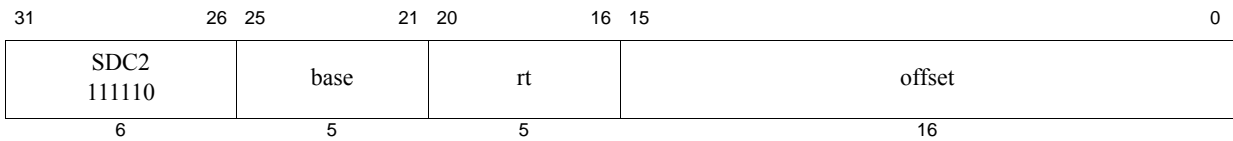

Release 6

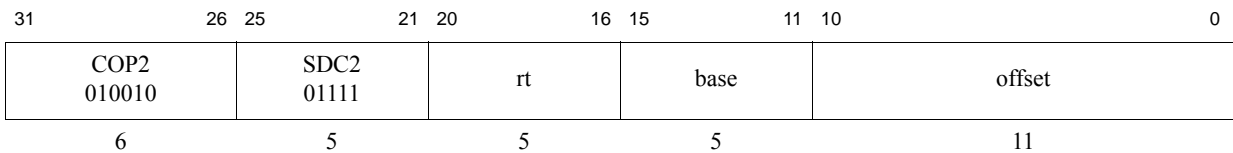
**Format:** SDC2 rt, offset(base)**MIPS32****Purpose:** Store Doubleword from Coprocessor 2

To store a doubleword from a Coprocessor 2 register to memory

Description: $\text{memory}[\text{GPR}[\text{base}] + \text{offset}] \leftarrow \text{CPR}[2, \text{rt}, 0]$

The 64-bit doubleword in Coprocessor 2 register *rt* is stored in memory at the location specified by the aligned effective address. The 16-bit signed *offset* is added to the contents of GPR *base* to form the effective address.

Restrictions:

Pre-Release 6: An Address Error exception occurs if $\text{EffectiveAddress}_{2..0} \neq 0$ (not doubleword-aligned).

Release 6 allows hardware to provide address misalignment support in lieu of requiring natural alignment.

Note: The pseudocode is not completely adapted for Release 6 misalignment support as the handling is implementation dependent.

Availability and Compatibility:

This instruction has been recoded for Release 6.

Operation:

```

vAddr ← sign_extend(offset) + GPR[base]
(pAddr, CCA) ← AddressTranslation(vAddr, DATA, STORE)
lsw ← CPR[2, rt, 0]
msw ← CPR[2, rt+1, 0]
paddr ← paddr xor ((BigEndianCPU xor ReverseEndian) || 02)
StoreMemory(CCA, WORD, lsw, pAddr, vAddr, DATA)
paddr ← paddr xor 0b100
StoreMemory(CCA, WORD, msw, pAddr, vAddr+4, DATA)

```

Exceptions:

Coprocessor Unusable, Reserved Instruction, TLB Refill, TLB Invalid, TLB Modified, Address Error, Watch

Programming Notes:

As shown in the instruction drawing above, Release 6 implements an 11-bit offset, whereas all release levels lower than Release 6 of the MIPS architecture implement a 16-bit offset.

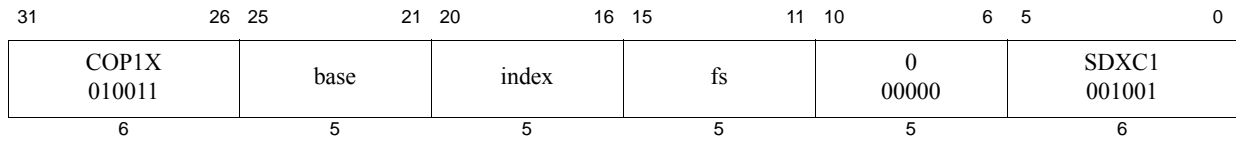

Format: SDXC1 fs, index(base)

MIPS64, MIPS32 Release 2, removed in Release 6

Purpose: Store Doubleword Indexed from Floating Point

To store a doubleword from an FPR to memory (GPR+GPR addressing).

Description: $\text{memory}[\text{GPR}[\text{base}] + \text{GPR}[\text{index}]] \leftarrow \text{FPR}[\text{fs}]$

The 64-bit doubleword in FPR *fs* is stored in memory at the location specified by the aligned effective address. The contents of GPR *index* and GPR *base* are added to form the effective address.

Restrictions:

An Address Error exception occurs if $\text{EffectiveAddress}_{2..0} \neq 0$ (not doubleword-aligned).

Availability and Compatibility:

This instruction has been removed in Release 6.

Required in all versions of MIPS64 since MIPS64 Release 1. Not available in MIPS32 Release 1. Required in MIPS32 Release 2 and all subsequent versions of MIPS32. When required, these instructions are to be implemented if an FPU is present either in a 32-bit or 64-bit FPU or in a 32-bit or 64-bit FP Register Mode ($\text{FIR}_{F64}=0$ or 1, $\text{Status}_{FR}=0$ or 1).

Operation:

```

vAddr ← GPR[base] + GPR[index]
if vAddr2..0 ≠ 03 then
    SignalException(AddressError)
endif
(pAddr, CCA) ← AddressTranslation(vAddr, DATA, STORE)
datadoubleword ← ValueFPR(fs, UNINTERPRETED_DOUBLEWORD)
paddr ← paddr xor ((BigEndianCPU xor ReverseEndian) || 02)
StoreMemory(CCA, WORD, datadoubleword31..0, pAddr, vAddr, DATA)
paddr ← paddr xor 0b100
StoreMemory(CCA, WORD, datadoubleword63..32, pAddr, vAddr+4, DATA)

```

Exceptions:

TLB Refill, TLB Invalid, TLB Modified, Coprocessor Unusable, Address Error, Reserved Instruction, Watch.

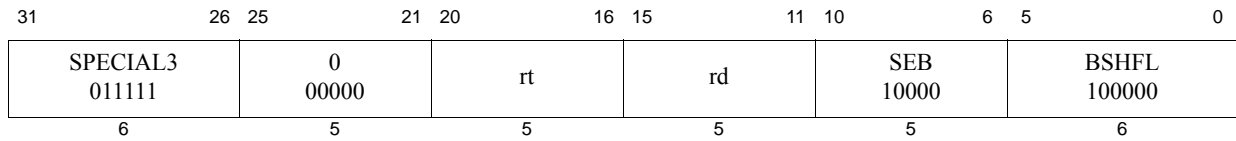

Format: SEB rd, rt

MIPS32 Release 2

Purpose: Sign-Extend Byte

To sign-extend the least significant byte of GPR *rt* and store the value into GPR *rd*.

Description: $\text{GPR}[rd] \leftarrow \text{SignExtend}(\text{GPR}[rt]_{7..0})$

The least significant byte from GPR *rt* is sign-extended and stored in GPR *rd*.

Restrictions:

Prior to architecture Release 2, this instruction resulted in a Reserved Instruction exception.

Operation:

$\text{GPR}[rd] \leftarrow \text{sign_extend}(\text{GPR}[rt]_{7..0})$

Exceptions:

Reserved Instruction

Programming Notes:

For symmetry with the SEB and SEH instructions, you expect that there would be ZEB and ZEH instructions that zero-extend the source operand and expect that the SEW and ZEW instructions would exist to sign- or zero-extend a word to a doubleword. These instructions do not exist because there are functionally-equivalent instructions already in the instruction set. The following table shows the instructions providing the equivalent functions.

Expected Instruction	Function	Equivalent Instruction
ZEB rx, ry	Zero-Extend Byte	ANDI rx, ry, 0xFF
ZEH rx, ry	Zero-Extend Halfword	ANDI rx, ry, 0xFFFF

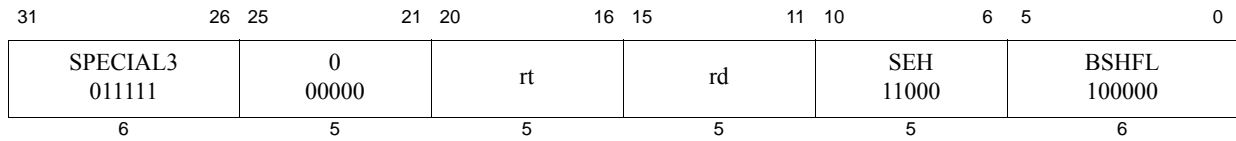

Format: SEH rd, rt

MIPS32 Release 2

Purpose: Sign-Extend Halfword

To sign-extend the least significant halfword of GPR *rt* and store the value into GPR *rd*.

Description: $GPR[rd] \leftarrow \text{SignExtend}(GPR[rt]_{15..0})$

The least significant halfword from GPR *rt* is sign-extended and stored in GPR *rd*.

Restrictions:

In implementations prior to Release 2 of the architecture, this instruction resulted in a Reserved Instruction exception.

Operation:

$GPR[rd] \leftarrow \text{sign_extend}(GPR[rt]_{15..0})$

Exceptions:

Reserved Instruction

Programming Notes:

The SEH instruction can be used to convert two contiguous halfwords to sign-extended word values in three instructions. For example:

```
lw    t0, 0(a1)           /* Read two contiguous halfwords */
seh   t1, t0              /* t1 = lower halfword sign-extended to word */
sra   t0, t0, 16         /* t0 = upper halfword sign-extended to word */
```

Zero-extended halfwords can be created by changing the SEH and SRA instructions to ANDI and SRL instructions, respectively.

For symmetry with the SEB and SEH instructions, you expect that there would be ZEB and ZEH instructions that zero-extend the source operand and expect that the SEW and ZEW instructions would exist to sign- or zero-extend a word to a doubleword. These instructions do not exist because there are functionally-equivalent instructions already in the instruction set. The following table shows the instructions providing the equivalent functions.

Expected Instruction	Function	Equivalent Instruction
ZEB rx, ry	Zero-Extend Byte	ANDI rx, ry, 0xFF
ZEH rx, ry	Zero-Extend Halfword	ANDI rx, ry, 0xFFFF

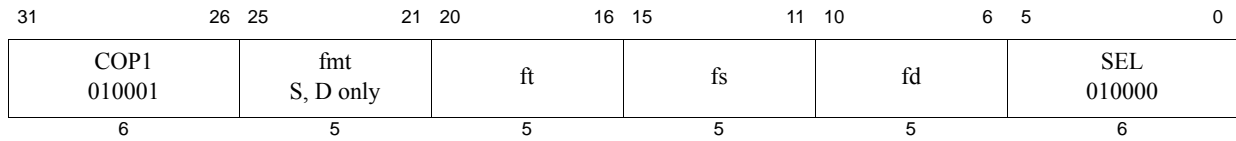

Format: SEL.fmt

SEL.S fd, fs, ft
SEL.D fd, fs, ft

MIPS32 Release 6
MIPS32 Release 6

Purpose: Select floating point values with FPR condition

Description: $FPR[fd] \leftarrow FPR[fd].bit0 ? FPR[ft] : FPR[fs]$

SEL.fmt is a select operation, with a condition input in FPR fd, and 2 data inputs in FPRs ft and fs.

- If the condition is true, the value of ft is written to fd.
- If the condition is false, the value of fs is written to fd.

The condition input is specified by FPR fd, and is overwritten by the result.

The condition is true only if bit 0 of the condition input FPR fd is set. Other bits are ignored.

This instruction has floating point formats S and D, but these specify only the width of the operands. SEL.S can be used for 32-bit W data, and SEL.D can be used for 64 bit L data.

This instruction does not cause data-dependent exceptions. It does not trap on NaNs, and the $FCSR_{Cause}$ and $FCSR_{Flags}$ fields are not modified.

Restrictions:

None

Availability and Compatibility:

SEL.fmt is introduced by and required as of MIPS32 Release 6.

Special Considerations:

Only formats S and D are valid. Other format values may be used to encode other instructions. Unused format encodings are required to signal the Reserved Instruction exception.

Operation:

```
tmp ← ValueFPR(fd, UNINTERPRETED_WORD)
cond ← tmp.bit0
if cond then
    tmp ← ValueFPR(ft, fmt)
else
    tmp ← ValueFPR(fs, fmt)
endif
StoreFPR(fd, fmt, tmp)
```

Exceptions:

Coprocessor Unusable, Reserved Instruction

Floating Point Exceptions:

None

31	26 25	21 20	16 15	11 10	6 5	0
SPECIAL 000000	rs	rt	rd	00000	SELEQZ 110101	
SPECIAL 000000	rs	rt	rd	00000	SELNEZ 110111	
6	5	5	5	5	6	

Format: SELEQZ SELNEZ
SELEQZ rd,rs,rt
SELNEZ rd,rs,rt

MIPS32 Release 6
MIPS32 Release 6

Purpose: Select integer GPR value or zero

Description:

SELEQZ: $GPR[rd] \leftarrow GPR[rt] ? 0 : GPR[rs]$
SELNEZ: $GPR[rd] \leftarrow GPR[rt] ? GPR[rs] : 0$

- SELEQZ is a select operation, with a condition input in GPR *rt*, one explicit data input in GPR *rs*, and implicit data input 0. The condition is true only if all bits in GPR *rt* are zero.
- SELNEZ is a select operation, with a condition input in GPR *rt*, one explicit data input in GPR *rs*, and implicit data input 0. The condition is true only if any bit in GPR *rt* is nonzero

If the condition is true, the value of *rs* is written to *rd*.

If the condition is false, the zero is written to *rd*.

This instruction operates on all GPRLen bits of the CPU registers, that is, all 32 bits on a 32-bit CPU, and all 64 bits on a 64-bit CPU. All GPRLen bits of *rt* are tested.

Restrictions:

None

Availability and Compatibility:

These instructions are introduced by and required as of MIPS32 Release 6.

Special Considerations:

None

Operation:

```
SELNEZ: cond ← GPR[rt] ≠ 0
SELEQZ: cond ← GPR[rt] = 0
if cond then
    tmp ← GPR[rs]
else
    tmp ← 0
endif
GPR[rd] ← tmp
```

Exceptions:

None

Programming Note:

Release 6 removes the Pre-Release 6 instructions MOVZ and MOVN:

```
MOVZ: if GPR[rt] = 0 then GPR[rd] ← GPR[rs]
MOVN: if GPR[rt] ≠ 0 then GPR[rd] ← GPR[rs]
```

MOVZ can be emulated using Release 6 instructions as follows:

```
SELEQZ at, rs, rt
SELNEZ rd, rd, rt
OR rd, rd, at
```

Similarly MOVN:

```
SELNEZ at, rs, rt
SELEQZ rd, rd, rt
OR rd, rd, at
```

The more general select operation requires 4 registers (1 output + 3 inputs (1 condition + 2 data)) and can be expressed:

```
rD ← if rC then rA else rB
```

The more general select can be created using Release 6 instructions as follows:

```
SELNEZ at, rB, rC
SELNEZ rD, rA, rC
OR rD, rD, at
```

31	26 25	21 20	16 15	11 10	6 5	0
COP1 010001	fmt S, D only	ft	fs	fd	SELEQZ 010100	
COP1 010001	fmt S, D only	ft	fs	fd	SELNEZ 010111	
6	5	5	5	5	6	

Format: SELEQZ.fmt SELNEQZ.fmt
 SELEQZ.S fd, fs, ft
 SELEQZ.D fd, fs, ft
 SELNEZ.S fd, fs, ft
 SELNEZ.D fd, fs, ft

MIPS32 Release 6
 MIPS32 Release 6
 MIPS32 Release 6
 MIPS32 Release 6

Purpose: Select floating point value or zero with FPR condition.

Description:

```
SELEQZ.fmt: FPR[fd] ← FPR[ft].bit0 ? 0 : FPR[fs]
SELNEZ.fmt: FPR[fd] ← FPR[ft].bit0 ? FPR[fs] : 0
```

- SELEQZ.fmt is a select operation, with a condition input in FPR ft, one explicit data input in FPR fs, and implicit data input 0. The condition is true only if bit 0 of FPR ft is zero.
- SELNEZ.fmt is a select operation, with a condition input in FPR ft, one explicit data input in FPR fs, and implicit data input 0. The condition is true only if bit 0 of FPR ft is nonzero.

If the condition is true, the value of fs is written to fd.

If the condition is false, the value that has all bits zero is written to fd.

This instruction has floating point formats S and D, but these specify only the width of the operands. Format S can be used for 32-bit W data, and format D can be used for 64 bit L data. The condition test is restricted to bit 0 of FPR ft. Other bits are ignored.

This instruction has no execution exception behavior. It does not trap on NaNs, and the *FCSR_{Cause}* and *FCSR_{Flags}* fields are not modified.

Restrictions:

FPR fd destination register bits beyond the format width are UNPREDICTABLE. For example, if fmt is S, then fd bits 0-31 are defined, but bits 32 and above are UNPREDICTABLE. If fmt is D, then fd bits 0-63 are defined.

Availability and Compatibility:

These instructions are introduced by and required as of MIPS32 Release 6.

Special Considerations:

Only formats S and D are valid. Other format values may be used to encode other instructions. Unused format encodings are required to signal the Reserved Instruction exception.

Operation:

```
tmp ← ValueFPR(ft, UNINTERPRETED_WORD)
SELEQZ: cond ← tmp.bit0 = 0
SELNEZ: cond ← tmp.bit0 ≠ 0
if cond then
    tmp ← ValueFPR(fs, fmt)
else
```

```
    tmp ← 0 /* all bits set to zero */  
endif  
StoreFPR(fd, fmt, tmp)
```

Exceptions:

Coprocessor Unusable, Reserved Instruction

Floating Point Exceptions:

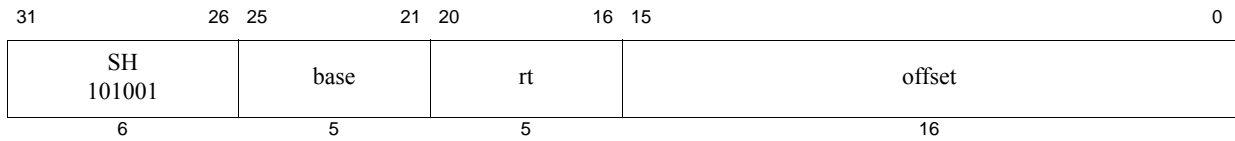

Format: SH *rt*, *offset* (*base*)

MIPS32

Purpose: Store Halfword

To store a halfword to memory.

Description: $\text{memory}[\text{GPR}[\text{base}] + \text{offset}] \leftarrow \text{GPR}[\text{rt}]$

The least-significant 16-bit halfword of register *rt* is stored in memory at the location specified by the aligned effective address. The 16-bit signed *offset* is added to the contents of GPR *base* to form the effective address.

Restrictions:

Pre-Release 6: The effective address must be naturally-aligned. If the least-significant bit of the address is non-zero, an Address Error exception occurs.

Release 6 allows hardware to provide address misalignment support in lieu of requiring natural alignment.

Note: The pseudocode is not completely adapted for Release 6 misalignment support as the handling is implementation dependent.

Operation:

```

vAddr ← sign_extend(offset) + GPR[base]
(pAddr, CCA) ← AddressTranslation (vAddr, DATA, STORE)
pAddr ← pAddr_PSIZE-1..2 || (pAddr_1..0 xor (ReverseEndian || 0))
bytesel ← vAddr_1..0 xor (BigEndianCPU || 0)
dataword ← GPR[rt]_31-8*bytesel..0 || 08*bytesel
StoreMemory (CCA, HALFWORD, dataword, pAddr, vAddr, DATA)

```

Exceptions:

TLB Refill, TLB Invalid, TLB Modified, Address Error, Watch

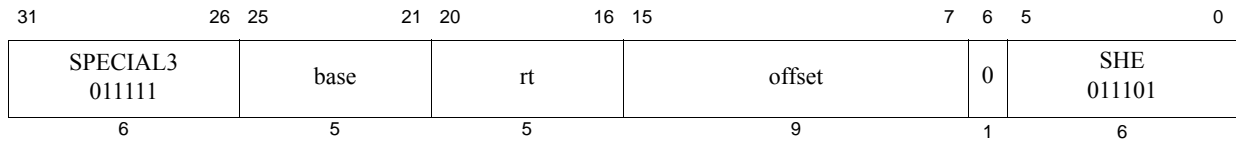

Format: SHE *rt*, *offset*(*base*)

MIPS32

Purpose: Store Halfword EVA

To store a halfword to user mode virtual address space when executing in kernel mode.

Description: $\text{memory}[\text{GPR}[\text{base}] + \text{offset}] \leftarrow \text{GPR}[\text{rt}]$

The least-significant 16-bit halfword of register *rt* is stored in memory at the location specified by the aligned effective address. The 9-bit signed *offset* is added to the contents of GPR *base* to form the effective address.

The SHE instruction functions the same as the SH instruction, except that address translation is performed using the user mode virtual address space mapping in the TLB when accessing an address within a memory segment configured to use the MUSUK access mode. Memory segments using UUSK or MUSK access modes are also accessible. Refer to Volume III, Enhanced Virtual Addressing section for additional information.

Implementation of this instruction is specified by the *Config5_{EVA}* field being set to 1.

Restrictions:

Only usable in kernel mode when accessing an address within a segment configured using UUSK, MUSK or MUSUK access mode.

Pre-Release 6: The effective address must be naturally-aligned. If the least-significant bit of the address is non-zero, an Address Error exception occurs.

Release 6 allows hardware to provide address misalignment support in lieu of requiring natural alignment.

Note: The pseudocode is not completely adapted for Release 6 misalignment support as the handling is implementation dependent.

Operation:

```
vAddr ← sign_extend(offset) + GPR[base]
(pAddr, CCA) ← AddressTranslation(vAddr, DATA, STORE)
pAddr ← pAddrPSIZE-1..2 || (pAddr1..0 xor (ReverseEndian || 0))
bytesel ← vAddr1..0 xor (BigEndianCPU || 0)
dataword ← GPR[rt]31-8*bytesel..0 || 08*bytesel
StoreMemory(CCA, HALFWORD, dataword, pAddr, vAddr, DATA)
```

Exceptions:

TLB Refill, TLB Invalid, Bus Error, Address Error, Watch, Reserved Instruction, Coprocessor Unusable

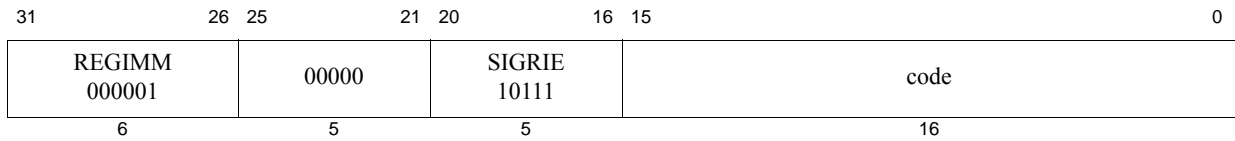

Format: SIGRIE code

MIPS32 Release 6

Purpose: Signal Reserved Instruction Exception

The SIGRIE instruction signals a Reserved Instruction exception.

Description: `SignalException(ReservedInstruction)`

The SIGRIE instruction signals a Reserved Instruction exception. Implementations should use exactly the same mechanisms as they use for reserved instructions that are not defined by the Architecture.

The 16-bit *code* field is available for software use.

Restrictions:

The 16-bit *code* field is available for software use. The value zero is considered the default value. Software may provide extended functionality by interpreting nonzero values of the *code* field in a manner that is outside the scope of this architecture specification.

Availability and Compatibility:

This instruction is introduced by and required as of Release 6.

Pre-Release 6: this instruction encoding was reserved, and required to signal a Reserved Instruction exception. Therefore this instruction can be considered to be both backwards and forwards compatible.

Operation:

`SignalException(ReservedInstruction)`

Exceptions:

Reserved Instruction

31	26 25	21 20	16 15	11 10	6 5	0
SPECIAL 000000	0 00000	rt	rd	sa	SLL 000000	
6	5	5	5	5	6	

Format: SLL rd, rt, sa

MIPS32

Purpose: Shift Word Left Logical

To left-shift a word by a fixed number of bits.

Description: $GPR[rd] \leftarrow GPR[rt] \ll sa$

The contents of the low-order 32-bit word of GPR *rt* are shifted left, inserting zeros into the emptied bits. The word result is placed in GPR *rd*. The bit-shift amount is specified by *sa*.

Restrictions:

None

Operation:

```

s ← sa
temp ← GPR[rt] (31-s)..0 || 0s
GPR[rd] ← temp

```

Exceptions:

None

Programming Notes:

SLL r0, r0, 0, expressed as NOP, is the assembly idiom used to denote no operation.

SLL r0, r0, 1, expressed as SSNOP, is the assembly idiom used to denote no operation that causes an issue break on superscalar processors.

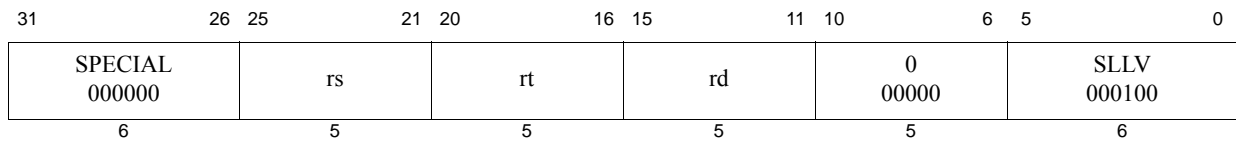

Format: SLLV rd, rt, rs

MIPS32

Purpose: Shift Word Left Logical Variable

To left-shift a word by a variable number of bits.

Description: $GPR[rd] \leftarrow GPR[rt] \ll GPR[rs]$

The contents of the low-order 32-bit word of GPR *rt* are shifted left, inserting zeros into the emptied bits. The resulting word is placed in GPR *rd*. The bit-shift amount is specified by the low-order 5 bits of GPR *rs*.

Restrictions:

None

Operation:

```

s ← GPR[rs]4..0
temp ← GPR[rt](31-s)..0 || 0s
GPR[rd] ← temp

```

Exceptions:

None

Programming Notes:

None

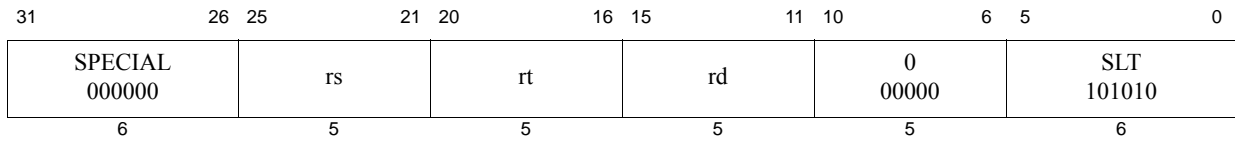

Format: SLT rd, rs, rt

MIPS32

Purpose: Set on Less Than

To record the result of a less-than comparison.

Description: $GPR[rd] \leftarrow (GPR[rs] < GPR[rt])$

Compare the contents of GPR *rs* and GPR *rt* as signed integers; record the Boolean result of the comparison in GPR *rd*. If GPR *rs* is less than GPR *rt*, the result is 1 (true); otherwise, it is 0 (false).

The arithmetic comparison does not cause an Integer Overflow exception.

Restrictions:

None

Operation:

```

if GPR[rs] < GPR[rt] then
    GPR[rd] ← 0GPRLEN-1 || 1
else
    GPR[rd] ← 0GPRLEN
endif

```

Exceptions:

None

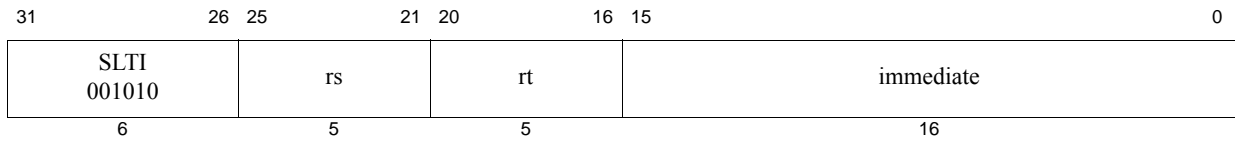

Format: SLTI *rt*, *rs*, *immediate*

MIPS32

Purpose: Set on Less Than Immediate

To record the result of a less-than comparison with a constant.

Description: $GPR[rt] \leftarrow (GPR[rs] < \text{sign_extend}(\text{immediate}))$

Compare the contents of GPR *rs* and the 16-bit signed *immediate* as signed integers; record the Boolean result of the comparison in GPR *rt*. If GPR *rs* is less than *immediate*, the result is 1 (true); otherwise, it is 0 (false).

The arithmetic comparison does not cause an Integer Overflow exception.

Restrictions:

None

Operation:

```

if GPR[rs] < sign_extend(immediate) then
    GPR[rt] ← 0GPRLEN-1 || 1
else
    GPR[rt] ← 0GPRLEN
endif

```

Exceptions:

None

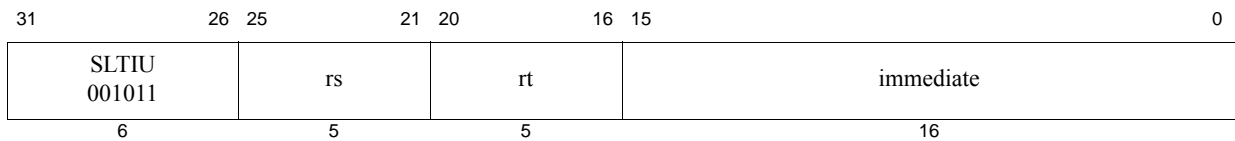

Format: SLTIU *rt*, *rs*, *immediate*

MIPS32

Purpose: Set on Less Than Immediate Unsigned

To record the result of an unsigned less-than comparison with a constant.

Description: $GPR[rt] \leftarrow (GPR[rs] < \text{sign_extend}(\text{immediate}))$

Compare the contents of GPR *rs* and the sign-extended 16-bit *immediate* as unsigned integers; record the Boolean result of the comparison in GPR *rt*. If GPR *rs* is less than *immediate*, the result is 1 (true); otherwise, it is 0 (false).

Because the 16-bit *immediate* is sign-extended before comparison, the instruction can represent the smallest or largest unsigned numbers. The representable values are at the minimum [0, 32767] or maximum [*max_unsigned*-32767, *max_unsigned*] end of the unsigned range.

The arithmetic comparison does not cause an Integer Overflow exception.

Restrictions:

None

Operation:

```

if (0 || GPR[rs]) < (0 || sign_extend(immediate)) then
    GPR[rt] ← 0GPRLEN-1 || 1
else
    GPR[rt] ← 0GPRLEN
endif

```

Exceptions:

None

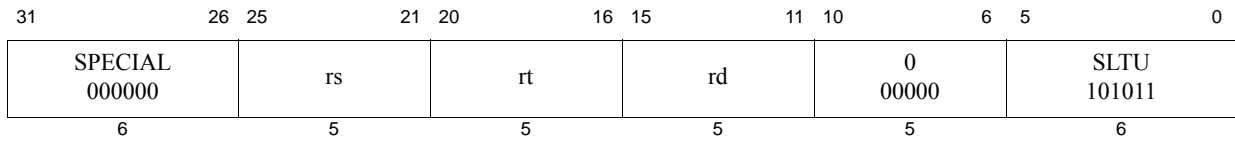

Format: SLTU rd, rs, rt

MIPS32

Purpose: Set on Less Than Unsigned

To record the result of an unsigned less-than comparison.

Description: $GPR[rd] \leftarrow (GPR[rs] < GPR[rt])$

Compare the contents of GPR *rs* and GPR *rt* as unsigned integers; record the Boolean result of the comparison in GPR *rd*. If GPR *rs* is less than GPR *rt*, the result is 1 (true); otherwise, it is 0 (false).

The arithmetic comparison does not cause an Integer Overflow exception.

Restrictions:

None

Operation:

```

if (0 || GPR[rs]) < (0 || GPR[rt]) then
    GPR[rd] ← 0GPRLEN-1 || 1
else
    GPR[rd] ← 0GPRLEN
endif

```

Exceptions:

None

31	26 25	21 20	16 15	11 10	6 5	0
COP1 010001	fmt	0 00000	fs	fd	SQR.T 000100	
6	5	5	5	5	6	

Format: SQR.T.fmt
 SQR.T.S fd, fs
 SQR.T.D fd, fs

MIPS32
MIPS32

Purpose: Floating Point Square Root

To compute the square root of an FP value.

Description: $FPR[fd] \leftarrow SQR.T(FPR[fs])$

The square root of the value in FPR *fs* is calculated to infinite precision, rounded according to the current rounding mode in *FCSR*, and placed into FPR *fd*. The operand and result are values in format *fmt*.

If the value in FPR *fs* corresponds to -0 , the result is -0 .

Restrictions:

If the value in FPR *fs* is less than 0, an Invalid Operation condition is raised.

The fields *fs* and *fd* must specify FPRs valid for operands of type *fmt*. If the fields are not valid, the result is **UNPREDICTABLE**.

The operand must be a value in format *fmt*; if it is not, the result is **UNPREDICTABLE** and the value of the operand FPR becomes **UNPREDICTABLE**.

Operation:

```
StoreFPR(fd, fmt, SquareRoot(ValueFPR(fs, fmt)))
```

Exceptions:

Coprocessor Unusable, Reserved Instruction

Floating Point Exceptions:

Invalid Operation, Inexact, Unimplemented Operation

31	26 25	21 20	16 15	11 10	6 5	0
SPECIAL 000000	0 00000	rt	rd	sa	SRA 000011	
6	5	5	5	5	6	

Format: SRA rd, rt, sa

MIPS32

Purpose: Shift Word Right Arithmetic

To execute an arithmetic right-shift of a word by a fixed number of bits.

Description: $GPR[rd] \leftarrow GPR[rt] \gg sa$ (arithmetic)

The contents of the low-order 32-bit word of GPR *rt* are shifted right, duplicating the sign-bit (bit 31) in the emptied bits; the word result is placed in GPR *rd*. The bit-shift amount is specified by *sa*.

Restrictions:

None

Operation:

```

s ← sa
temp ← GPR[rt]31s || GPR[rt]31..s
GPR[rd] ← temp

```

Exceptions:

None

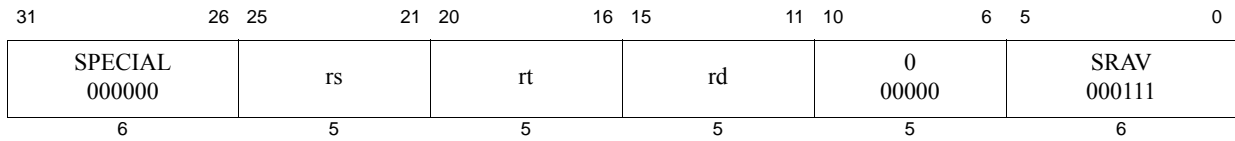

Format: SRAV *rd*, *rt*, *rs*

MIPS32

Purpose: Shift Word Right Arithmetic Variable

To execute an arithmetic right-shift of a word by a variable number of bits.

Description: $GPR[rd] \leftarrow GPR[rt] \gg GPR[rs]$ (arithmetic)

The contents of the low-order 32-bit word of GPR *rt* are shifted right, duplicating the sign-bit (bit 31) in the emptied bits; the word result is placed in GPR *rd*. The bit-shift amount is specified by the low-order 5 bits of GPR *rs*.

Restrictions:

None

Operation:

```

s ← GPR[rs]4..0
temp ← (GPR[rt]31)s || GPR[rt]31..s
GPR[rd] ← temp

```

Exceptions:

None

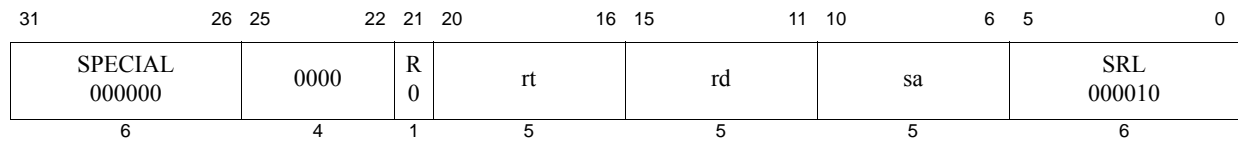

Format: SRL rd, rt, sa

MIPS32

Purpose: Shift Word Right Logical

To execute a logical right-shift of a word by a fixed number of bits.

Description: $GPR[rd] \leftarrow GPR[rt] \gg sa$ (logical)

The contents of the low-order 32-bit word of GPR *rt* are shifted right, inserting zeros into the emptied bits. The word result is placed in GPR *rd*. The bit-shift amount is specified by *sa*.

Restrictions:

None

Operation:

```

s ← sa
temp ← 0s || GPR[rt]31..s
GPR[rd] ← temp

```

Exceptions:

None

31	26 25	21 20	16 15	11 10	7 6 5	0
SPECIAL 000000	rs	rt	rd	0000	R 0	SRLV 000110
6	5	5	5	4	1	6

Format: SRLV rd, rt, rs

MIPS32

Purpose: Shift Word Right Logical Variable

To execute a logical right-shift of a word by a variable number of bits.

Description: $GPR[rd] \leftarrow GPR[rt] \gg GPR[rs]$ (logical)

The contents of the low-order 32-bit word of GPR *rt* are shifted right, inserting zeros into the emptied bits; the word result is placed in GPR *rd*. The bit-shift amount is specified by the low-order 5 bits of GPR *rs*.

Restrictions:

None

Operation:

```

s ← GPR[rs]4..0
temp ← 0s || GPR[rt]31..s
GPR[rd] ← temp

```

Exceptions:

None

31	26 25	21 20	16 15	11 10	6 5	0
SPECIAL 000000	0 00000	0 00000	0 00000	1 00001	SLL 000000	
6	5	5	5	5	6	

Format: SSNOP

Assembly Idiom MIPS32

Purpose: Superscalar No Operation

Break superscalar issue on a superscalar processor.

Description:

SSNOP is the assembly idiom used to denote superscalar no operation. The actual instruction is interpreted by the hardware as SLL r0, r0, 1.

This instruction alters the instruction issue behavior on a superscalar processor by forcing the SSNOP instruction to single-issue. The processor must then end the current instruction issue between the instruction previous to the SSNOP and the SSNOP. The SSNOP then issues alone in the next issue slot.

On a single-issue processor, this instruction is a NOP that takes an issue slot.

Restrictions:

None

Availability and Compatibility

Release 6: the special no-operation instruction SSNOP is deprecated: it behaves the same as a conventional NOP. Its special behavior with respect to instruction issue is no longer guaranteed. The EHB and JR.HB instructions are provided to clear execution and instruction hazards.

Assemblers targeting specifically Release 6 should reject the SSNOP instruction with an error.

Operation:

None

Exceptions:

None

Programming Notes:

SSNOP is intended for use primarily to allow the programmer control over CP0 hazards by converting instructions into cycles in a superscalar processor. For example, to insert at least two cycles between an MTC0 and an ERET, one would use the following sequence:

```

mtc0    x,y
ssnop
ssnop
eret

```

The MTC0 issues in cycle T. Because the SSNOP instructions must issue alone, they may issue no earlier than cycle T+1 and cycle T+2, respectively. Finally, the ERET issues no earlier than cycle T+3. Although the instruction after an SSNOP may issue no earlier than the cycle after the SSNOP is issued, that instruction may issue later. This is because other implementation-dependent issue rules may apply that prevent an issue in the next cycle. Processors should not introduce any unnecessary delay in issuing SSNOP instructions.

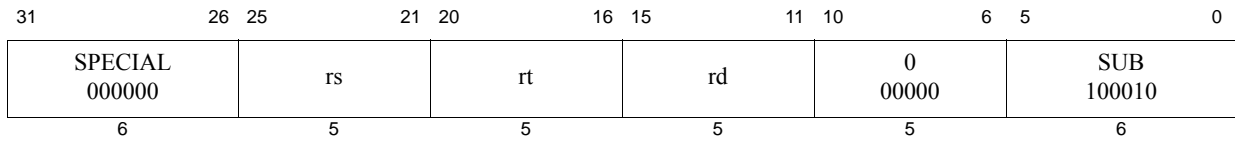

Format: SUB *rd*, *rs*, *rt*

MIPS32

Purpose: Subtract Word

To subtract 32-bit integers. If overflow occurs, then trap.

Description: $GPR[rd] \leftarrow GPR[rs] - GPR[rt]$

The 32-bit word value in GPR *rt* is subtracted from the 32-bit value in GPR *rs* to produce a 32-bit result. If the subtraction results in 32-bit 2's complement arithmetic overflow, then the destination register is not modified and an Integer Overflow exception occurs. If it does not overflow, the 32-bit result is placed into GPR *rd*.

Restrictions:

None

Operation:

```
temp ← (GPR[rs]31 | GPR[rs]31..0) - (GPR[rt]31 | GPR[rt]31..0)
if temp32 ≠ temp31 then
    SignalException(IntegerOverflow)
else
    GPR[rd] ← temp31..0
endif
```

Exceptions:

Integer Overflow

Programming Notes:

SUBU performs the same arithmetic operation but does not trap on overflow.

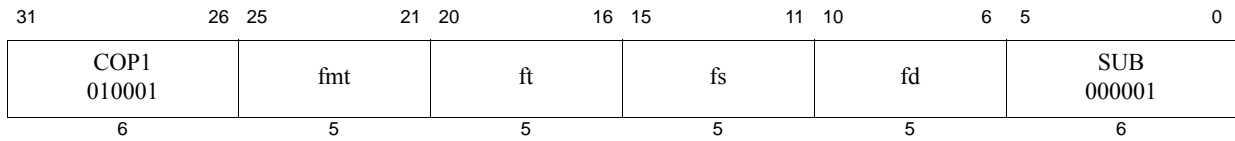

Format: SUB.fmt
 SUB.S *fd*, *fs*, *ft*
 SUB.D *fd*, *fs*, *ft*
 SUB.PS *fd*, *fs*, *ft*

MIPS32
MIPS32
MIPS64, MIPS32 Release 2, removed in Release 6

Purpose: Floating Point Subtract

To subtract FP values.

Description: $FPR[fd] \leftarrow FPR[fs] - FPR[ft]$

The value in FPR *ft* is subtracted from the value in FPR *fs*. The result is calculated to infinite precision, rounded according to the current rounding mode in *FCSR*, and placed into FPR *fd*. The operands and result are values in format *fmt*. SUB.PS subtracts the upper and lower halves of FPR *fs* and FPR *ft* independently, and ORs together any generated exceptional conditions.

Restrictions:

The fields *fs*, *ft*, and *fd* must specify FPRs valid for operands of type *fmt*. If the fields are not valid, the result is **UNPREDICTABLE**.

The operands must be values in format *fmt*; if they are not, the result is **UNPREDICTABLE** and the value of the operand FPRs becomes **UNPREDICTABLE**.

The result of SUB.PS is **UNPREDICTABLE** if the processor is executing in the FR=0 32-bit FPU register model; it is predictable if executing on a 64-bit FPU in the *FR*=1 mode, but not with *FR*=0, and not on a 32-bit FPU.

Availability and Compatibility:

SUB.PS has been removed in Release 6.

Operation:

StoreFPR (*fd*, *fmt*, ValueFPR(*fs*, *fmt*) $_{-fmt}$ ValueFPR(*ft*, *fmt*))

CPU Exceptions:

Coprocessor Unusable, Reserved Instruction

FPU Exceptions:

Inexact, Overflow, Underflow, Invalid Op, Unimplemented Op

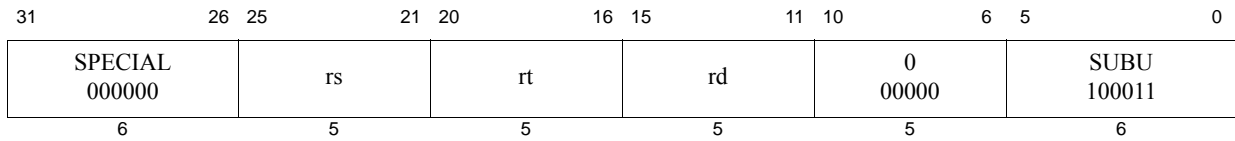

Format: SUBU *rd*, *rs*, *rt*

MIPS32

Purpose: Subtract Unsigned Word

To subtract 32-bit integers.

Description: $GPR[rd] \leftarrow GPR[rs] - GPR[rt]$

The 32-bit word value in GPR *rt* is subtracted from the 32-bit value in GPR *rs* and the 32-bit arithmetic result is and placed into GPR *rd*.

No integer overflow exception occurs under any circumstances.

Restrictions:

None

Operation:

```
temp ← GPR[rs] - GPR[rt]
GPR[rd] ← temp
```

Exceptions:

None

Programming Notes:

The term “unsigned” in the instruction name is a misnomer; this operation is 32-bit modulo arithmetic that does not trap on overflow. It is appropriate for unsigned arithmetic, such as address arithmetic, or integer arithmetic environments that ignore overflow, such as C language arithmetic.

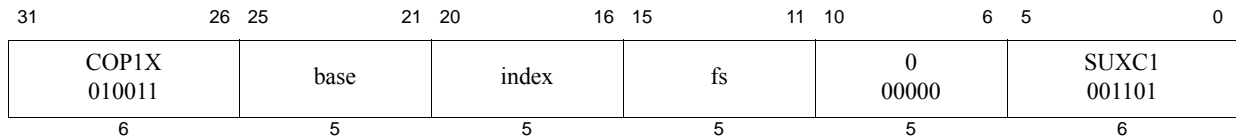

Format: SUXC1 fs, index(base)

MIPS64,MIPS32 Release 2, removed in Release 6

Purpose: Store Doubleword Indexed Unaligned from Floating Point

To store a doubleword from an FPR to memory (GPR+GPR addressing) ignoring alignment.

Description: $\text{memory}[(\text{GPR}[\text{base}] + \text{GPR}[\text{index}])_{\text{PSIZE}-1..3}] \leftarrow \text{FPR}[\text{fs}]$

The contents of the 64-bit doubleword in FPR *fs* is stored at the memory location specified by the effective address. The contents of GPR *index* and GPR *base* are added to form the effective address. The effective address is doubleword-aligned; EffectiveAddress_{2..0} are ignored.

Restrictions:

The result of this instruction is **UNPREDICTABLE** if the processor is executing in the *FR=0* 32-bit FPU register model. The instruction is predictable if executing on a 64-bit FPU in the *FR=1* mode, but not with *FR=0*, and not on a 32-bit FPU.

Availability and Compatibility

This instruction has been removed in Release 6.

Operation:

```
vAddr ← (GPR[base]+GPR[index])63..3 || 03
(pAddr, CCA) ← AddressTranslation(vAddr, DATA, STORE)
datadoubleword ← ValueFPR(fs, UNINTERPRETED_DOUBLEWORD)
paddr ← paddr xor ((BigEndianCPU xor ReverseEndian) || 02)
StoreMemory(CCA, WORD, datadoubleword31..0, pAddr, vAddr, DATA)
paddr ← paddr xor 0b100
StoreMemory(CCA, WORD, datadoubleword63..32, pAddr, vAddr+4, DATA)
```

Exceptions:

Coprocessor Unusable, Reserved Instruction, TLB Refill, TLB Invalid, TLB Modified, Watch

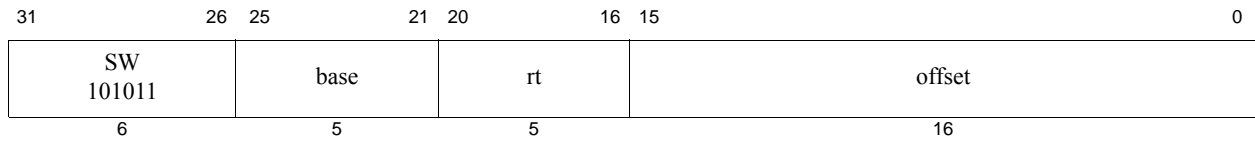

Format: `SW rt, offset(base)`

MIPS32

Purpose: Store Word

To store a word to memory.

Description: $\text{memory}[\text{GPR}[\text{base}] + \text{offset}] \leftarrow \text{GPR}[\text{rt}]$

The least-significant 32-bit word of GPR *rt* is stored in memory at the location specified by the aligned effective address. The 16-bit signed *offset* is added to the contents of GPR *base* to form the effective address.

Restrictions:

Pre-Release 6: The effective address must be naturally-aligned. If either of the 2 least-significant bits of the address is non-zero, an Address Error exception occurs.

Release 6 allows hardware to provide address misalignment support in lieu of requiring natural alignment.

Note: The pseudocode is not completely adapted for Release 6 misalignment support as the handling is implementation dependent.

Operation:

```
vAddr ← sign_extend(offset) + GPR[base]
(pAddr, CCA) ← AddressTranslation(vAddr, DATA, STORE)
dataword ← GPR[rt]
StoreMemory(CCA, WORD, dataword, pAddr, vAddr, DATA)
```

Exceptions:

TLB Refill, TLB Invalid, TLB Modified, Address Error, Watch

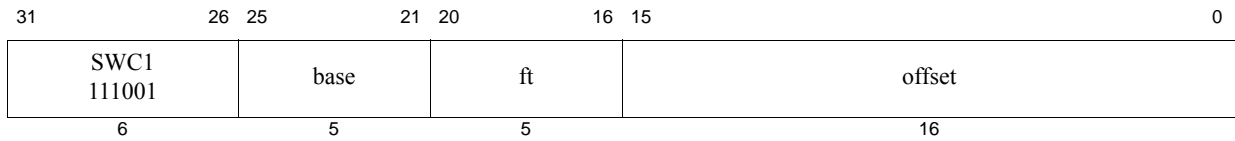

SWC1 *ft*, *offset*(*base*)

MIPS32

Purpose: Store Word from Floating Point

To store a word from an FPR to memory.

Description: $\text{memory}[\text{GPR}[\text{base}] + \text{offset}] \leftarrow \text{FPR}[\text{ft}]$

The low 32-bit word from FPR *ft* is stored in memory at the location specified by the aligned effective address. The 16-bit signed *offset* is added to the contents of GPR *base* to form the effective address.

Restrictions:

Pre-Release 6: An Address Error exception occurs if $\text{EffectiveAddress}_{1..0} \neq 0$ (not word-aligned).

Release 6 allows hardware to provide address misalignment support in lieu of requiring natural alignment.

Note: The pseudocode is not completely adapted for Release 6 misalignment support as the handling is implementation dependent.

Operation:

```
vAddr ← sign_extend(offset) + GPR[base]
(pAddr, CCA) ← AddressTranslation(vAddr, DATA, STORE)
dataword ← ValueFPR(ft, UNINTERPRETED_WORD)
StoreMemory(CCA, WORD, dataword, pAddr, vAddr, DATA)
```

Exceptions:

Coprocessor Unusable, Reserved Instruction, TLB Refill, TLB Invalid, TLB Modified, Address Error, Watch

pre-Release 6

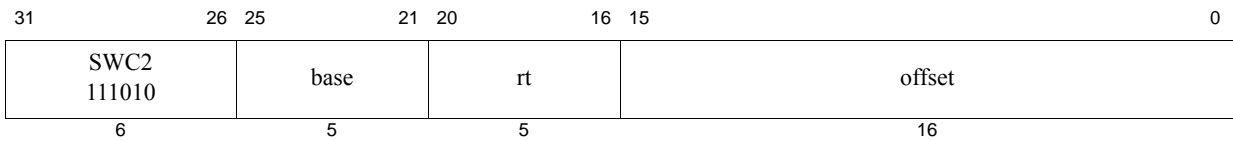

Release 6

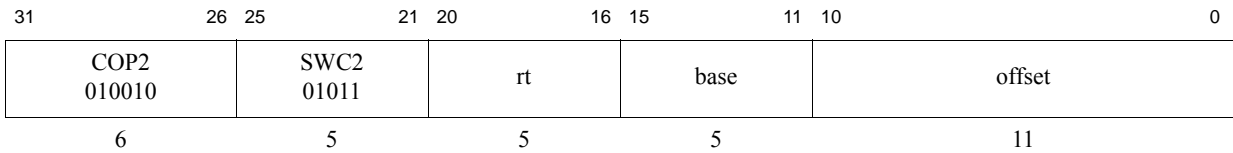
**Format:** SWC2 rt, offset(base)**MIPS32****Purpose:** Store Word from Coprocessor 2

To store a word from a COP2 register to memory

Description: $\text{memory}[\text{GPR}[\text{base}] + \text{offset}] \leftarrow \text{CPR}[2, \text{rt}, 0]$

The low 32-bit word from COP2 (Coprocessor 2) register *rt* is stored in memory at the location specified by the aligned effective address. The signed *offset* is added to the contents of GPR *base* to form the effective address.

Restrictions:

Pre-Release 6: An Address Error exception occurs if $\text{EffectiveAddress}_{1..0} \neq 0$ (not word-aligned).

Release 6 allows hardware to provide address misalignment support in lieu of requiring natural alignment.

Note: The pseudocode is not completely adapted for Release 6 misalignment support as the handling is implementation dependent.

Availability and Compatibility

This instruction has been recoded for Release 6.

Operation:

```
vAddr ← sign_extend(offset) + GPR[base]
(pAddr, CCA) ← AddressTranslation(vAddr, DATA, STORE)
dataword ← CPR[2,rt,0]
StoreMemory(CCA, WORD, dataword, pAddr, vAddr, DATA)
```

Exceptions:

Coprocessor Unusable, Reserved Instruction, TLB Refill, TLB Invalid, TLB Modified, Address Error, Watch

Programming Notes:

As shown in the instruction drawing above, Release 6 implements an 11-bit offset, whereas all release levels lower than Release 6 of the MIPS architecture implement a 16-bit offset.

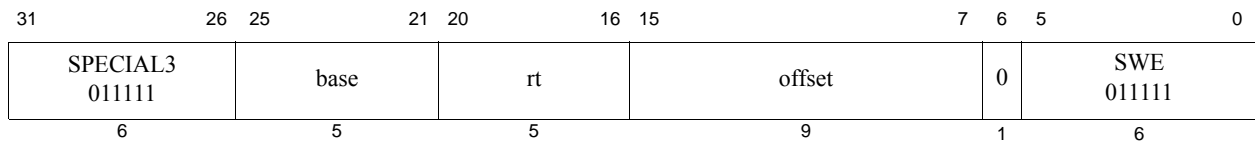

Format: SWE *rt*, *offset*(*base*)

MIPS32

Purpose: Store Word EVA

To store a word to user mode virtual address space when executing in kernel mode.

Description: $\text{memory}[\text{GPR}[\text{base}] + \text{offset}] \leftarrow \text{GPR}[\text{rt}]$

The least-significant 32-bit word of GPR *rt* is stored in memory at the location specified by the aligned effective address. The 9-bit signed *offset* is added to the contents of GPR *base* to form the effective address.

The SWE instruction functions the same as the SW instruction, except that address translation is performed using the user mode virtual address space mapping in the TLB when accessing an address within a memory segment configured to use the MUSUK access mode. Memory segments using UUSK or MUSK access modes are also accessible. Refer to Volume III, Enhanced Virtual Addressing section for additional information.

Implementation of this instruction is specified by the *Config5_{EVA}* field being set to 1.

Restrictions:

Only usable in kernel mode when accessing an address within a segment configured using UUSK, MUSK or MUSUK access mode.

Pre-Release 6: The effective address must be naturally-aligned. If either of the 2 least-significant bits of the address is non-zero, an Address Error exception occurs.

Release 6 allows hardware to provide address misalignment support in lieu of requiring natural alignment.

Note: The pseudocode is not completely adapted for Release 6 misalignment support as the handling is implementation dependent.

Operation:

```
vAddr ← sign_extend(offset) + GPR[base]
(pAddr, CCA) ← AddressTranslation(vAddr, DATA, STORE)
dataword ← GPR[rt]
StoreMemory(CCA, WORD, dataword, pAddr, vAddr, DATA)
```

Exceptions:

TLB Refill, TLB Invalid, Bus Error, Address Error, Watch, Reserved Instruction, Coprocessor Unusable

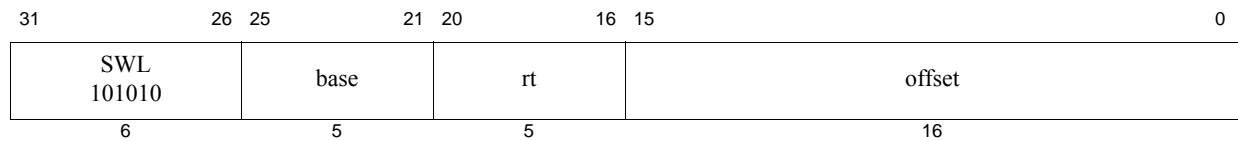

Format: SWL *rt*, *offset*(*base*)

MIPS32, removed in Release 6

Purpose: Store Word Left

To store the most-significant part of a word to an unaligned memory address.

Description: $\text{memory}[\text{GPR}[\text{base}] + \text{offset}] \leftarrow \text{GPR}[\text{rt}]$

The 16-bit signed *offset* is added to the contents of GPR *base* to form an effective address (*EffAddr*). *EffAddr* is the address of the most-significant of 4 consecutive bytes forming a word (*W*) in memory starting at an arbitrary byte boundary.

A part of *W* (the most-significant 1 to 4 bytes) is in the aligned word containing *EffAddr*. The same number of the most-significant (left) bytes from the word in GPR *rt* are stored into these bytes of *W*.

The following figure illustrates this operation using big-endian byte ordering for 32-bit and 64-bit registers. The four consecutive bytes in 2..5 form an unaligned word starting at location 2. A part of *W* (2 bytes) is located in the aligned word containing the most-significant byte at 2.

- SWL stores the most-significant 2 bytes of the low word from the source register into these 2 bytes in memory.
- The complementary SWR stores the remainder of the unaligned word.

Figure 5.9 Unaligned Word Store Using SWL and SWR

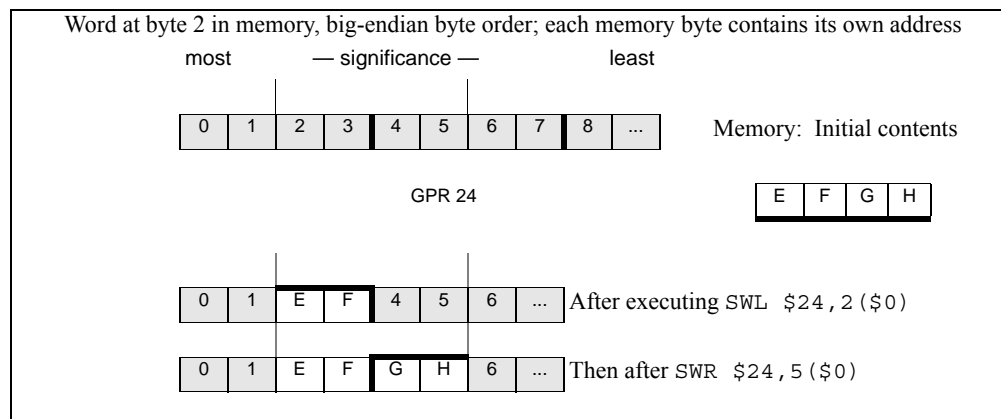

The bytes stored from the source register to memory depend on both the offset of the effective address within an aligned word—that is, the low 2 bits of the address ($vAddr_{1..0}$)—and the current byte-ordering mode of the processor (big- or little-endian). The following figure shows the bytes stored for every combination of offset and byte ordering.

Figure 5.10 Bytes Stored by an SWL Instruction

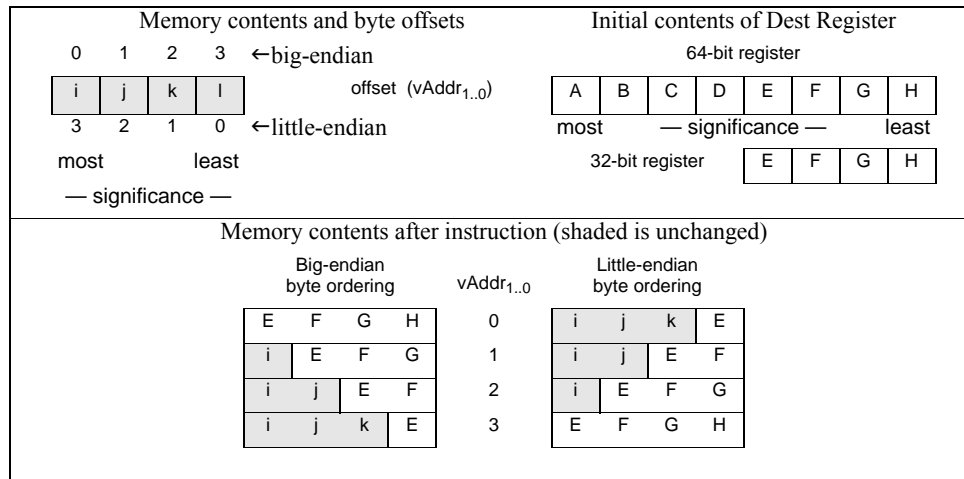
**Restrictions:**

None

Availability and Compatibility:

Release 6 removes the load/store-left/right family of instructions, and requires the system to support misaligned memory accesses.

Operation:

```

vAddr ← sign_extend(offset) + GPR[base]
(pAddr, CCA) ← AddressTranslation(vAddr, DATA, STORE)
pAddr ← pAddrPSIZE-1..2 || (pAddr1..0 xor ReverseEndian2)
If BigEndianMem = 0 then
  pAddr ← pAddrPSIZE-1..2 || 02
endif
byte ← vAddr1..0 xor BigEndianCPU2
dataword ← 024-8*byte || GPR[rt]31..24-8*byte
StoreMemory(CCA, byte, dataword, pAddr, vAddr, DATA)

```

Exceptions:

TLB Refill, TLB Invalid, TLB Modified, Bus Error, Address Error, Watch

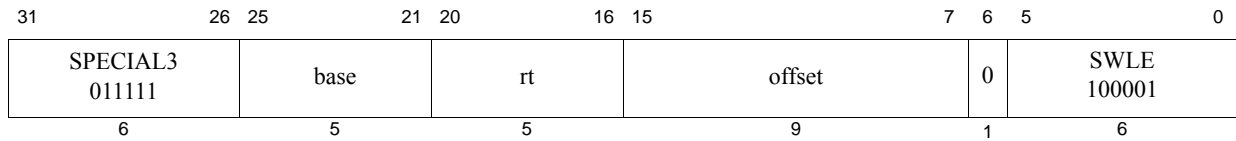

Format: SWLE *rt*, *offset*(*base*)

MIPS32, removed in Release 6

Purpose: Store Word Left EVA

To store the most-significant part of a word to an unaligned user mode virtual address while operating in kernel mode.

Description: $\text{memory}[\text{GPR}[\text{base}] + \text{offset}] \leftarrow \text{GPR}[\text{rt}]$

The 9-bit signed *offset* is added to the contents of GPR *base* to form an effective address (*EffAddr*). *EffAddr* is the address of the most-significant of 4 consecutive bytes forming a word (*W*) in memory starting at an arbitrary byte boundary.

A part of *W* (the most-significant 1 to 4 bytes) is in the aligned word containing *EffAddr*. The same number of the most-significant (left) bytes from the word in GPR *rt* are stored into these bytes of *W*.

The following figure shows this operation using big-endian byte ordering for 32-bit and 64-bit registers. The 4 consecutive bytes in 2..5 form an unaligned word starting at location 2. A part of *W* (2 bytes) is located in the aligned word containing the most-significant byte at 2.

1. SWLE stores the most-significant 2 bytes of the low word from the source register into these 2 bytes in memory.
2. The complementary SWRE stores the remainder of the unaligned word.

Figure 5.11 Unaligned Word Store Using SWLE and SWRE

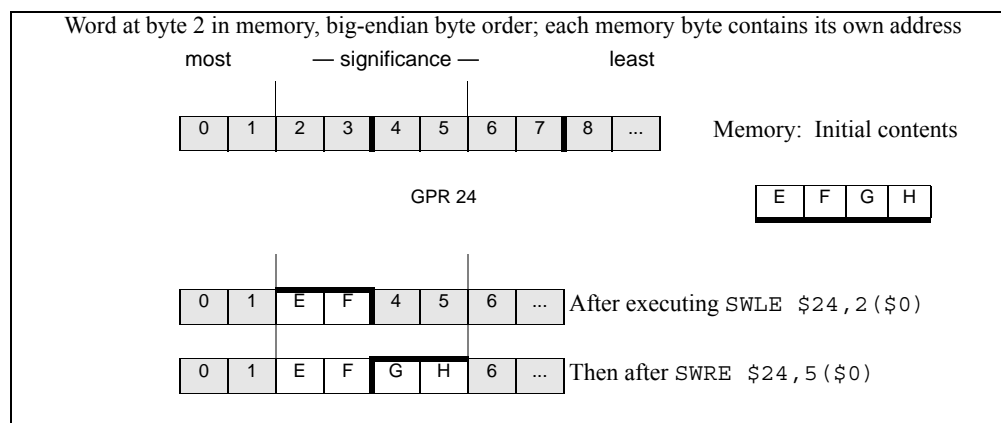

The bytes stored from the source register to memory depend on both the offset of the effective address within an aligned word—that is, the low 2 bits of the address ($vAddr_{1..0}$)—and the current byte-ordering mode of the processor (big- or little-endian). The following figure shows the bytes stored for every combination of offset and byte ordering.

The SWLE instruction functions the same as the SWL instruction, except that address translation is performed using the user mode virtual address space mapping in the TLB when accessing an address within a memory segment configured to use the MUSUK access mode. Memory segments using UUSK or MUSK access modes are also accessible. Refer to Volume III, Enhanced Virtual Addressing section for additional information.

Implementation of this instruction is specified by the *Config5_{EVA}* field being set to 1.

Figure 5.12 Bytes Stored by an SWLE Instruction

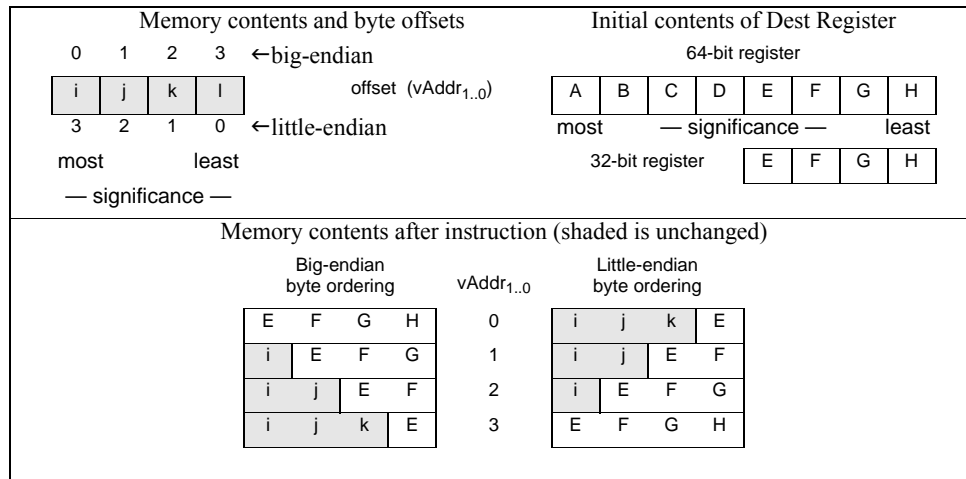
**Restrictions:**

Only usable when access to Coprocessor0 is enabled and when accessing an address within a segment configured using UUSK, MUSK or MUSUK access mode.

Availability and Compatibility:

Release 6 removes the load/store-left/right family of instructions, and requires the system to support misaligned memory accesses.

Operation:

```

vAddr ← sign_extend(offset) + GPR[base]
(pAddr, CCA) ← AddressTranslation(vAddr, DATA, STORE)
pAddr ← pAddr_PSIZE-1..2 || (pAddr1..0 xor ReverseEndian2)
If BigEndianMem = 0 then
  pAddr ← pAddr_PSIZE-1..2 || 02
endif
byte ← vAddr1..0 xor BigEndianCPU2
dataword ← 024-8*byte || GPR[rt]31..24-8*byte
StoreMemory(CCA, byte, dataword, pAddr, vAddr, DATA)

```

Exceptions:

TLB Refill, TLB Invalid, TLB Modified, Bus Error, Address Error, Watch, Reserved Instruction, Coprocessor Unusable

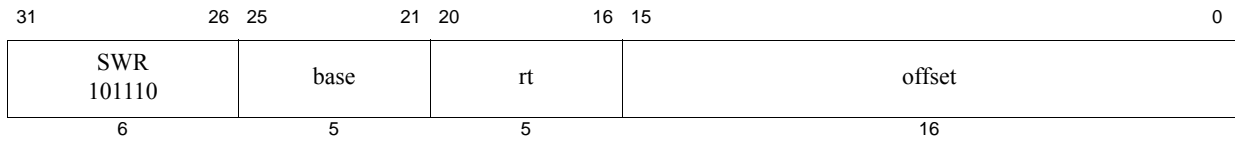

Format: SWR *rt*, *offset*(*base*)

MIPS32, removed in Release 6

Purpose: Store Word Right

To store the least-significant part of a word to an unaligned memory address.

Description: $\text{memory}[\text{GPR}[\text{base}] + \text{offset}] \leftarrow \text{GPR}[\text{rt}]$

The 16-bit signed *offset* is added to the contents of GPR *base* to form an effective address (*EffAddr*). *EffAddr* is the address of the least-significant of 4 consecutive bytes forming a word (*W*) in memory starting at an arbitrary byte boundary.

A part of *W* (the least-significant 1 to 4 bytes) is in the aligned word containing *EffAddr*. The same number of the least-significant (right) bytes from the word in GPR *rt* are stored into these bytes of *W*.

The following figure illustrates this operation using big-endian byte ordering for 32-bit and 64-bit registers. The 4 consecutive bytes in 2..5 form an unaligned word starting at location 2. A part of *W* (2 bytes) is contained in the aligned word containing the least-significant byte at 5.

1. SWR stores the least-significant 2 bytes of the low word from the source register into these 2 bytes in memory.
2. The complementary SWL stores the remainder of the unaligned word.

Figure 5.13 Unaligned Word Store Using SWR and SWL

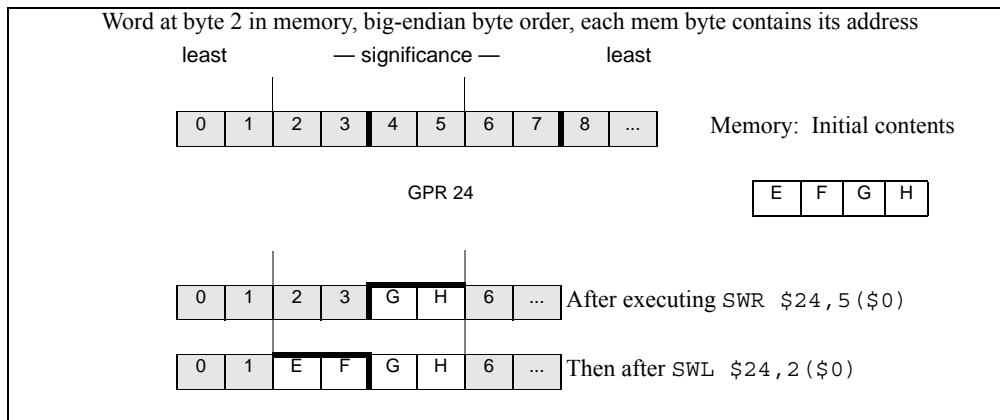

The bytes stored from the source register to memory depend on both the offset of the effective address within an aligned word—that is, the low 2 bits of the address ($vAddr_{1..0}$)—and the current byte-ordering mode of the processor (big- or little-endian). The following figure shows the bytes stored for every combination of offset and byte-ordering.

Figure 5.14 Bytes Stored by SWR Instruction

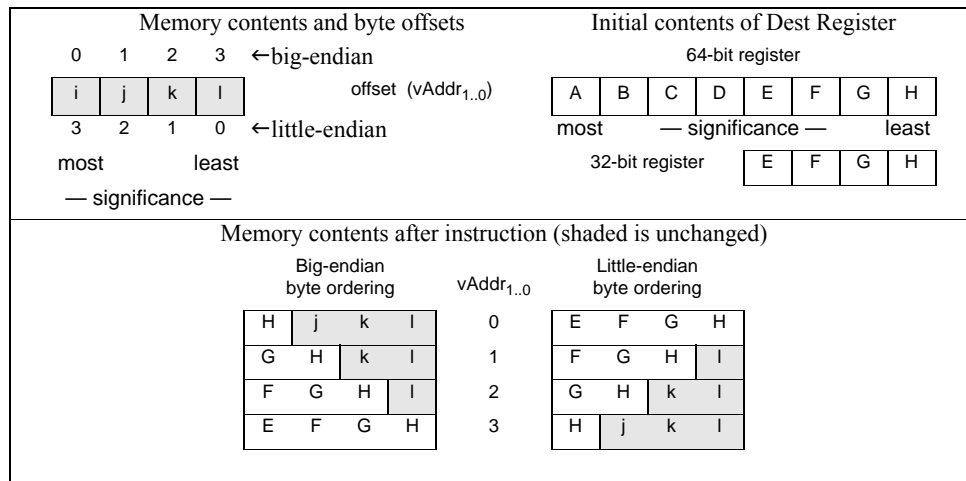
**Restrictions:**

None

Availability and Compatibility:

Release 6 removes the load/store-left/right family of instructions, and requires the system to support misaligned memory accesses.

Operation:

```

vAddr ← sign_extend(offset) + GPR[base]
(pAddr, CCA) ← AddressTranslation(vAddr, DATA, STORE)
pAddr ← pAddrPSIZE-1..2 || (pAddr1..0 xor ReverseEndian2)
If BigEndianMem = 0 then
    pAddr ← pAddrPSIZE-1..2 || 02
endif
byte ← vAddr1..0 xor BigEndianCPU2
dataword ← GPR[rt]31-8*byte || 08*byte
StoreMemory(CCA, WORD-byte, dataword, pAddr, vAddr, DATA)

```

Exceptions:

TLB Refill, TLB Invalid, TLB Modified, Bus Error, Address Error, Watch

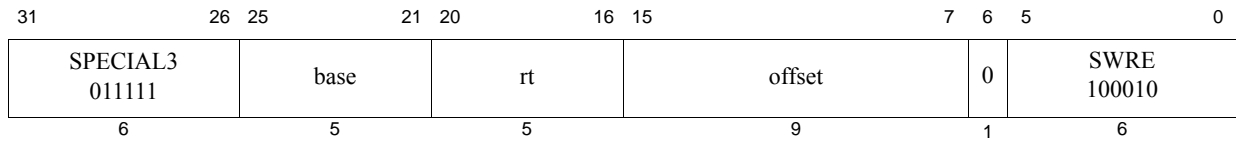

Format: SWRE *rt*, *offset*(*base*)

MIPS32, removed in Release 6

Purpose: Store Word Right EVA

To store the least-significant part of a word to an unaligned user mode virtual address while operating in kernel mode.

Description: $\text{memory}[\text{GPR}[\text{base}] + \text{offset}] \leftarrow \text{GPR}[\text{rt}]$

The 9-bit signed *offset* is added to the contents of GPR *base* to form an effective address (*EffAddr*). *EffAddr* is the address of the least-significant of 4 consecutive bytes forming a word (*W*) in memory starting at an arbitrary byte boundary.

A part of *W* (the least-significant 1 to 4 bytes) is in the aligned word containing *EffAddr*. The same number of the least-significant (right) bytes from the word in GPR *rt* are stored into these bytes of *W*.

The following figure illustrates this operation using big-endian byte ordering for 32-bit and 64-bit registers. The 4 consecutive bytes in 2..5 form an unaligned word starting at location 2. A part of *W* (2 bytes) is contained in the aligned word containing the least-significant byte at 5.

- SWRE stores the least-significant 2 bytes of the low word from the source register into these 2 bytes in memory.
- The complementary SWLE stores the remainder of the unaligned word.

Figure 5.15 Unaligned Word Store Using SWRE and SWLE

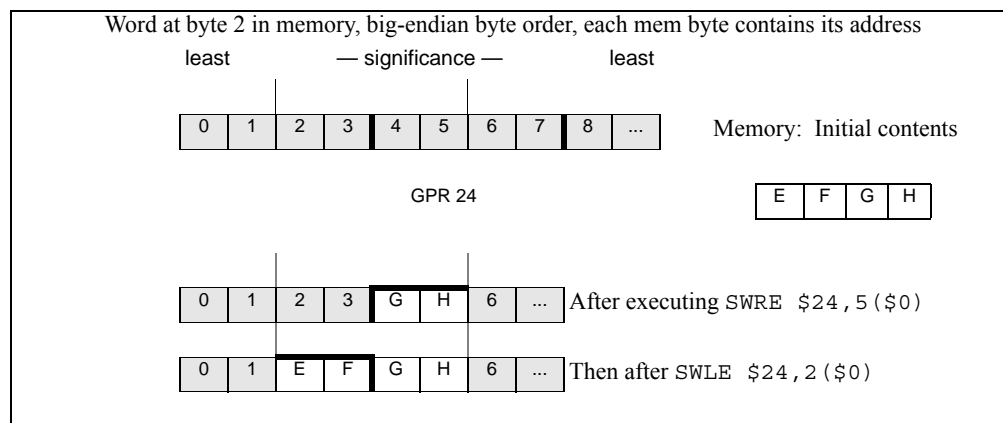

The bytes stored from the source register to memory depend on both the offset of the effective address within an aligned word—that is, the low 2 bits of the address ($v\text{Addr}_{1..0}$)—and the current byte-ordering mode of the processor (big- or little-endian). The following figure shows the bytes stored for every combination of offset and byte-ordering.

The LWE instruction functions the same as the LW instruction, except that address translation is performed using the user mode virtual address space mapping in the TLB when accessing an address within a memory segment configured to use the MUSUK access mode. Memory segments using UUSK or MUSK access modes are also accessible. Refer to Volume III, Enhanced Virtual Addressing section for additional information.

Implementation of this instruction is specified by the *Config5_{EVA}* field being set to 1.

Figure 5.16 Bytes Stored by SWRE Instruction

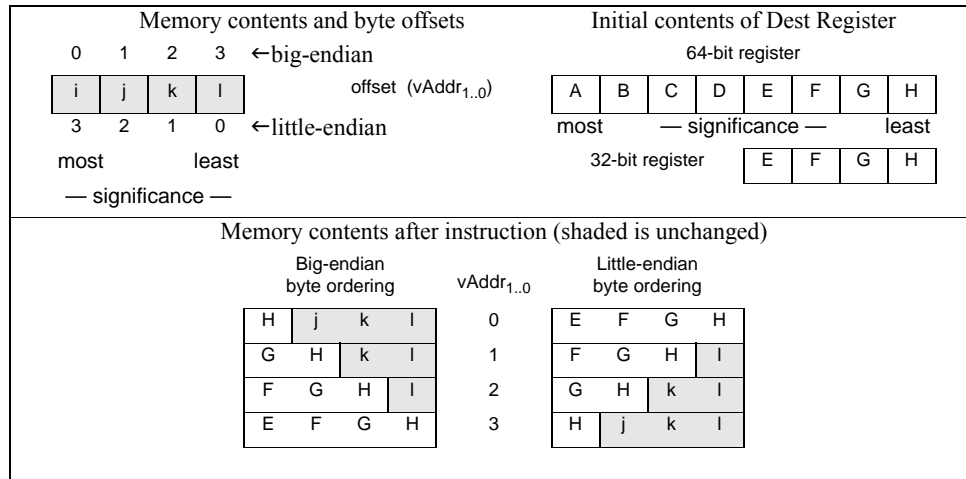
**Restrictions:**

Only usable when access to Coprocessor0 is enabled and when accessing an address within a segment configured using UUSK, MUSK or MUSUK access mode.

Availability and Compatibility:

Release 6 removes the load/store-left/right family of instructions, and requires the system to support misaligned memory accesses.

Operation:

```

vAddr ← sign_extend(offset) + GPR[base]
(pAddr, CCA) ← AddressTranslation(vAddr, DATA, STORE)
pAddr ← pAddrPSIZE-1..2 || (pAddr1..0 xor ReverseEndian2)
If BigEndianMem = 0 then
    pAddr ← pAddrPSIZE-1..2 || 02
endif
byte ← vAddr1..0 xor BigEndianCPU2
dataword ← GPR[rt]31-8*byte || 08*byte
StoreMemory(CCA, WORD-byte, dataword, pAddr, vAddr, DATA)

```

Exceptions:

TLB Refill, TLB Invalid, TLB Modified, Bus Error, Address Error, Watch, Coprocessor Unusable

31	26 25	21 20	16 15	11 10	6 5	0
COP1X 010011	base	index	fs	0 00000	SWXC1 001000	
6	5	5	5	5	6	

Format: SWXC1 fs, index(base)

MIPS64, MIPS32 Release 2, removed in Release 6

Purpose: Store Word Indexed from Floating Point

To store a word from an FPR to memory (GPR+GPR addressing)

Description: $\text{memory}[\text{GPR}[\text{base}] + \text{GPR}[\text{index}]] \leftarrow \text{FPR}[\text{fs}]$

The low 32-bit word from FPR *fs* is stored in memory at the location specified by the aligned effective address. The contents of GPR *index* and GPR *base* are added to form the effective address.

Restrictions:

An Address Error exception occurs if $\text{EffectiveAddress}_{1..0} \neq 0$ (not word-aligned).

Availability and Compatibility:

This instruction has been removed in Release 6.

Required in all versions of MIPS64 since MIPS64 Release 1. Not available in MIPS32 Release 1. Required in MIPS32 Release 2 and all subsequent versions of MIPS32. When required, required whenever FPU is present, whether a 32-bit or 64-bit FPU, whether in 32-bit or 64-bit FP Register Mode ($\text{FIR}_{F64}=0$ or 1, $\text{Status}_{FR}=0$ or 1).

Operation:

```
vAddr ← GPR[base] + GPR[index]
if vAddr1..0 ≠ 03 then
    SignalException(AddressError)
endif
(pAddr, CCA) ← AddressTranslation(vAddr, DATA, STORE)
dataword ← ValueFPR(fs, UNINTERPRETED_WORD)
StoreMemory(CCA, WORD, dataword, pAddr, vAddr, DATA)
```

Exceptions:

TLB Refill, TLB Invalid, TLB Modified, Address Error, Reserved Instruction, Coprocessor Unusable, Watch

31	26 25	21 20	16 15	11 10	6 5	0
SPECIAL 000000	0 00 0000 0000 0000 0			stype	SYNC 001111	
6	15			5	6	

Format: SYNC (styp = 0 implied)
SYNC styp

MIPS32
MIPS32

Purpose: Synchronize Shared Memory

To order loads and stores for shared memory.

Description:

These types of ordering guarantees are available through the SYNC instruction:

- Completion Barriers
- Ordering Barriers

Completion Barrier — Simple Description:

- The barrier affects only *uncached* and *cached coherent* loads and stores.
- The specified memory instructions (loads or stores or both) that occur before the SYNC instruction must be completed before the specified memory instructions after the SYNC are allowed to start.
- Loads are completed when the destination register is written. Stores are completed when the stored value is visible to every other processor in the system.

Completion Barrier — Detailed Description:

- Every synchronizable specified memory instruction (loads or stores or both) that occurs in the instruction stream before the SYNC instruction must be already globally performed before any synchronizable specified memory instructions that occur after the SYNC are allowed to be performed, with respect to any other processor or coherent I/O module.
- The barrier does not guarantee the order in which instruction fetches are performed.
- A styp value of zero will always be defined such that it performs the most complete set of synchronization operations that are defined. This means styp zero always does a completion barrier that affects both loads and stores preceding the SYNC instruction and both loads and stores that are subsequent to the SYNC instruction. Non-zero values of styp may be defined by the architecture or specific implementations to perform synchronization behaviors that are less complete than that of styp zero. If an implementation does not use one of these non-zero values to define a different synchronization behavior, then that non-zero value of styp must act the same as styp zero completion barrier. This allows software written for an implementation with a lighter-weight barrier to work on another implementation which only implements the styp zero completion barrier.
- A completion barrier is required, potentially in conjunction with SSNOP (in Release 1 of the Architecture) or EHB (in Release 2 of the Architecture), to guarantee that memory reference results are visible across operating mode changes. For example, a completion barrier is required on some implementations on entry to and exit from Debug Mode to guarantee that memory effects are handled correctly.

SYNC behavior when the styp field is zero:

- A completion barrier that affects preceding loads and stores and subsequent loads and stores.

Ordering Barrier — Simple Description:

- The barrier affects only *uncached* and *cached coherent* loads and stores.
- The specified memory instructions (loads or stores or both) that occur before the SYNC instruction must always be ordered before the specified memory instructions after the SYNC.
- Memory instructions which are ordered before other memory instructions are processed by the load/store datapath first before the other memory instructions.

Ordering Barrier — Detailed Description:

- Every synchronizable specified memory instruction (loads or stores or both) that occurs in the instruction stream before the SYNC instruction must reach a stage in the load/store datapath after which no instruction re-ordering is possible before any synchronizable specified memory instruction which occurs after the SYNC instruction in the instruction stream reaches the same stage in the load/store datapath.
- If any memory instruction before the SYNC instruction in program order, generates a memory request to the external memory and any memory instruction after the SYNC instruction in program order also generates a memory request to external memory, the memory request belonging to the older instruction must be globally performed before the time the memory request belonging to the younger instruction is globally performed.
- The barrier does not guarantee the order in which instruction fetches are performed.

As compared to the completion barrier, the ordering barrier is a lighter-weight operation as it does not require the specified instructions before the SYNC to be already completed. Instead it only requires that those specified instructions which are subsequent to the SYNC in the instruction stream are never re-ordered for processing ahead of the specified instructions which are before the SYNC in the instruction stream. This potentially reduces how many cycles the barrier instruction must stall before it completes.

The Acquire and Release barrier types are used to minimize the memory orderings that must be maintained and still have software synchronization work.

Implementations that do not use any of the non-zero values of *stype* to define different barriers, such as ordering barriers, must make those *stype* values act the same as *stype* zero.

For the purposes of this description, the CACHE, PEF and PREFX instructions are treated as loads and stores. That is, these instructions and the memory transactions sourced by these instructions obey the ordering and completion rules of the SYNC instruction.

Table 5.5 lists the available completion barrier and ordering barriers behaviors that can be specified using the stype field.

Table 5.5 Encodings of the Bits[10:6] of the SYNC instruction; the STYPE Field

Code	Name	Older instructions which must reach the load/store ordering point before the SYNC instruction completes.	Younger instructions which must reach the load/store ordering point only after the SYNC instruction completes.	Older instructions which must be globally performed when the SYNC instruction completes	Compliance
0x0	SYNC or SYNC 0	Loads, Stores	Loads, Stores	Loads, Stores	Required
0x4	SYNC_WMB or SYNC 4	Stores	Stores		Optional
0x10	SYNC_MB or SYNC 16	Loads, Stores	Loads, Stores		Optional
0x11	SYNC_ACQUIRE or SYNC 17	Loads	Loads, Stores		Optional
0x12	SYNC_RELEASE or SYNC 18	Loads, Stores	Stores		Optional
0x13	SYNC_RMB or SYNC 19	Loads	Loads		Optional
0x1-0x3, 0x5-0xF					Implementation-Specific and Vendor Specific Sync Types
0x14 - 0x1F	RESERVED				Reserved for MIPS Technologies for future extension of the architecture.

Terms:

Synchronizable: A load or store instruction is *synchronizable* if the load or store occurs to a physical location in shared memory using a virtual location with a memory access type of either *uncached* or *cached coherent*. *Shared memory* is memory that can be accessed by more than one processor or by a coherent I/O system module.

Performed load: A load instruction is *performed* when the value returned by the load has been determined. The result of a load on processor A has been *determined* with respect to processor or coherent I/O module B when a subsequent store to the location by B cannot affect the value returned by the load. The store by B must use the same memory access type as the load.

Performed store: A store instruction is *performed* when the store is observable. A store on processor A is *observable* with respect to processor or coherent I/O module B when a subsequent load of the location by B returns the value

written by the store. The load by B must use the same memory access type as the store.

Globally performed load: A load instruction is *globally performed* when it is performed with respect to all processors and coherent I/O modules capable of storing to the location.

Globally performed store: A store instruction is *globally performed* when it is globally observable. It is *globally observable* when it is observable by all processors and I/O modules capable of loading from the location.

Coherent I/O module: A *coherent I/O module* is an Input/Output system component that performs coherent Direct Memory Access (DMA). It reads and writes memory independently as though it were a processor doing loads and stores to locations with a memory access type of *cached coherent*.

Load/Store Datapath: The portion of the processor which handles the load/store data requests coming from the processor pipeline and processes those requests within the cache and memory system hierarchy.

Restrictions:

The effect of SYNC on the global order of loads and stores for memory access types other than *uncached* and *cached coherent* is **UNPREDICTABLE**.

Operation:

`SyncOperation(stype)`

Exceptions:

None

Programming Notes:

A processor executing load and store instructions observes the order in which loads and stores using the same memory access type occur in the instruction stream; this is known as *program order*.

A *parallel program* has multiple instruction streams that can execute simultaneously on different processors. In multiprocessor (MP) systems, the order in which the effects of loads and stores are observed by other processors—the *global order* of the loads and store—determines the actions necessary to reliably share data in parallel programs.

When all processors observe the effects of loads and stores in program order, the system is *strongly ordered*. On such systems, parallel programs can reliably share data without explicit actions in the programs. For such a system, SYNC has the same effect as a NOP. Executing SYNC on such a system is not necessary, but neither is it an error.

If a multiprocessor system is not strongly ordered, the effects of load and store instructions executed by one processor may be observed out of program order by other processors. On such systems, parallel programs must take explicit actions to reliably share data. At critical points in the program, the effects of loads and stores from an instruction stream must occur in the same order for all processors. SYNC separates the loads and stores executed on the processor into two groups, and the effect of all loads and stores in one group is seen by all processors before the effect of any load or store in the subsequent group. In effect, SYNC causes the system to be strongly ordered for the executing processor at the instant that the SYNC is executed.

Many MIPS-based multiprocessor systems are strongly ordered or have a mode in which they operate as strongly ordered for at least one memory access type. The MIPS architecture also permits implementation of MP systems that are not strongly ordered; SYNC enables the reliable use of shared memory on such systems. A parallel program that does not use SYNC generally does not operate on a system that is not strongly ordered. However, a program that does use SYNC works on both types of systems. (System-specific documentation describes the actions needed to reliably share data in parallel programs for that system.)

The behavior of a load or store using one memory access type is **UNPREDICTABLE** if a load or store was previously made to the same physical location using a different memory access type. The presence of a SYNC between the references does not alter this behavior.

SYNC affects the order in which the effects of load and store instructions appear to all processors; it does not gener-

ally affect the physical memory-system ordering or synchronization issues that arise in system programming. The effect of SYNC on implementation-specific aspects of the cached memory system, such as writeback buffers, is not defined.

```

# Processor A (writer)
# Conditions at entry:
# The value 0 has been stored in FLAG and that value is observable by B
SW    R1, DATA      # change shared DATA value
LI    R2, 1
SYNC                      # Perform DATA store before performing FLAG store
SW    R2, FLAG       # say that the shared DATA value is valid

# Processor B (reader)
LI    R2, 1
1: LW  R1, FLAG      # Get FLAG
BNE   R2, R1, 1B    # if it says that DATA is not valid, poll again
NOP
SYNC                      # FLAG value checked before doing DATA read
LW    R1, DATA     # Read (valid) shared DATA value

```

The code fragments above shows how SYNC can be used to coordinate the use of shared data between separate writer and reader instruction streams in a multiprocessor environment. The FLAG location is used by the instruction streams to determine whether the shared data item DATA is valid. The SYNC executed by processor A forces the store of DATA to be performed globally before the store to FLAG is performed. The SYNC executed by processor B ensures that DATA is not read until after the FLAG value indicates that the shared data is valid.

Software written to use a SYNC instruction with a non-zero stype value, expecting one type of barrier behavior, should only be run on hardware that actually implements the expected barrier behavior for that non-zero stype value or on hardware which implements a superset of the behavior expected by the software for that stype value. If the hardware does not perform the barrier behavior expected by the software, the system may fail.

Release 6

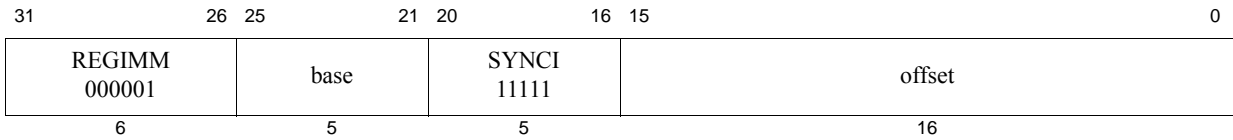
**Format:** SYNCI offset (base)**MIPS32 Release 2****Purpose:** Synchronize Caches to Make Instruction Writes Effective

To synchronize all caches to make instruction writes effective.

Description:

This instruction is used after a new instruction stream is written to make the new instructions effective relative to an instruction fetch, when used in conjunction with the SYNC and JALR.HB, JR.HB, or ERET instructions, as described below. Unlike the CACHE instruction, the SYNCI instruction is available in all operating modes in an implementation of Release 2 of the architecture.

The 16-bit offset is sign-extended and added to the contents of the base register to form an effective address. The effective address is used to address the cache line in all caches which may need to be synchronized with the write of the new instructions. The operation occurs only on the cache line which may contain the effective address. One SYNCI instruction is required for every cache line that was written. See the Programming Notes below.

A TLB Refill and TLB Invalid (both with cause code equal TLBL) exception can occur as a by product of this instruction. This instruction never causes TLB Modified exceptions nor TLB Refill exceptions with a cause code of TLBS. This instruction never causes Execute-Inhibit nor Read-Inhibit exceptions.

A Cache Error exception may occur as a by product of this instruction. For example, if a writeback operation detects a cache or bus error during the processing of the operation, that error is reported via a Cache Error exception. Similarly, a Bus Error Exception may occur if a bus operation invoked by this instruction is terminated in an error.

An Address Error Exception (with cause code equal AdEL) may occur if the effective address references a portion of the kernel address space which would normally result in such an exception. It is implementation dependent whether such an exception does occur.

It is implementation dependent whether a data watch is triggered by a SYNCI instruction whose address matches the Watch register address match conditions.

Restrictions:

The operation of the processor is **UNPREDICTABLE** if the effective address references any instruction cache line that contains instructions to be executed between the SYNCI and the subsequent JALR.HB, JR.HB, or ERET instruction required to clear the instruction hazard.

The SYNCI instruction has no effect on cache lines that were previously locked with the CACHE instruction. If correct software operation depends on the state of a locked line, the CACHE instruction must be used to synchronize the caches.

Full visibility of the new instruction stream requires execution of a subsequent SYNC instruction, followed by a JALR.HB, JR.HB, DERET, or ERET instruction. The operation of the processor is **UNPREDICTABLE** if this sequence is not followed.

SYNCI globalization:

The SYNCI instruction acts on the current processor at a minimum. Implementations are required to affect caches outside the current processor to perform the operation on the current processor (as might be the case if multiple processors share an L2 or L3 cache).

In multiprocessor implementations where instruction caches are coherently maintained by hardware, the SYNCI instruction should behave as a NOP instruction.

In multiprocessor implementations where instruction caches are not coherently maintained by hardware, the SYNCI instruction may optionally affect all coherent icaches within the system. If the effective address uses a coherent Cacheability and Coherency Attribute (CCA), then the operation may be *globalized*, meaning it is broadcast to all of the coherent instruction caches within the system. If the effective address does not use one of the coherent CCAs, there is no broadcast of the SYNCI operation. If multiple levels of caches are to be affected by one SYNCI instruction, all of the affected cache levels must be processed in the same manner - either all affected cache levels use the globalized behavior or all affected cache levels use the non-globalized behavior.

Pre-Release 6: Portable software could not rely on the optional *globalization* of SYNCI. Strictly portable software without implementation specific awareness could only rely on expensive “instruction cache shutdown” using inter-processor interrupts.

Release 6: SYNCI *globalization* is required. Compliant implementations must globalize SYNCI, and portable software can rely on this behavior.

Operation:

```
vaddr ← GPR[base] + sign_extend(offset)
SynchronizeCacheLines(vaddr)      /* Operate on all caches */
```

Exceptions:

Reserved Instruction exception (Release 1 implementations only)

TLB Refill Exception

TLB Invalid Exception

Address Error Exception

Cache Error Exception

Bus Error Exception

Programming Notes:

When the instruction stream is written, the SYNCI instruction should be used in conjunction with other instructions to make the newly-written instructions effective. The following example shows a routine which can be called after the new instruction stream is written to make those changes effective. The SYNCI instruction could be replaced with the corresponding sequence of CACHE instructions (when access to Coprocessor 0 is available), and that the JR.HB instruction could be replaced with JALR.HB, ERET, or DERET instructions, as appropriate. A SYNC instruction is required between the final SYNCI instruction in the loop and the instruction that clears instruction hazards.

```
/*
 * This routine makes changes to the instruction stream effective to the
 * hardware. It should be called after the instruction stream is written.
 * On return, the new instructions are effective.
 *
 * Inputs:
 *   a0 = Start address of new instruction stream
 *   a1 = Size, in bytes, of new instruction stream
 */

    beq    a1, zero, 20f          /* If size==0, */
    nop                                /* branch around */
    addu   a1, a0, a1            /* Calculate end address + 1 */
    rdhwr  v0, HW_SYNCI_Step     /* Get step size for SYNCI from new */
                                /* Release 2 instruction */
    beq    v0, zero, 20f         /* If no caches require synchronization, */
    nop                                /* branch around */
```

```
10: synci 0(a0)          /* Synchronize all caches around address */
    addu  a0, a0, v0     /* Add step size in delay slot */
    sltu  v1, a0, a1     /* Compare current with end address */
    bne   v1, zero, 10b /* Branch if more to do */
    nop                    /* branch around */
    sync                    /* Clear memory hazards */
20: jr.hb ra             /* Return, clearing instruction hazards */
    nop
```

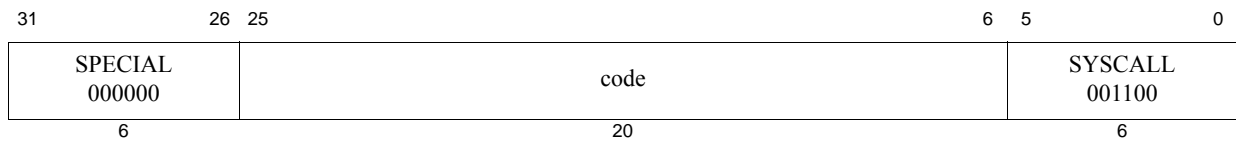

Format: SYSCALL

MIPS32

Purpose: System Call

To cause a System Call exception.

Description:

A system call exception occurs, immediately and unconditionally transferring control to the exception handler.

The *code* field is available for use as software parameters, but may be retrieved by the exception handler by loading the contents of the memory word containing the instruction. Optionally, if COP0 *BadInstr* is implemented, the *code* field may be obtained from *BadInstr*.

Restrictions:

None

Operation:

`SignalException(SystemCall)`

Exceptions:

System Call

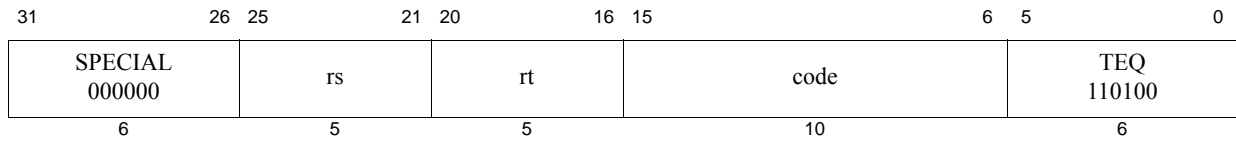

Format: TEQ *rs*, *rt*

MIPS32

Purpose: Trap if Equal

To compare GPRs and do a conditional trap.

Description: if GPR[*rs*] = GPR[*rt*] then Trap

Compare the contents of GPR *rs* and GPR *rt* as signed integers. If GPR *rs* is equal to GPR *rt*, then take a Trap exception.

The contents of the *code* field are ignored by hardware and may be used to encode information for system software. To retrieve the information, system software may load the instruction word from memory. Optionally, if COP0 *BadInstr* is implemented, the *code* field may be obtained from *BadInstr*.

Restrictions:

None

Operation:

```
if GPR[rs] = GPR[rt] then
    SignalException(Trap)
endif
```

Exceptions:

Trap

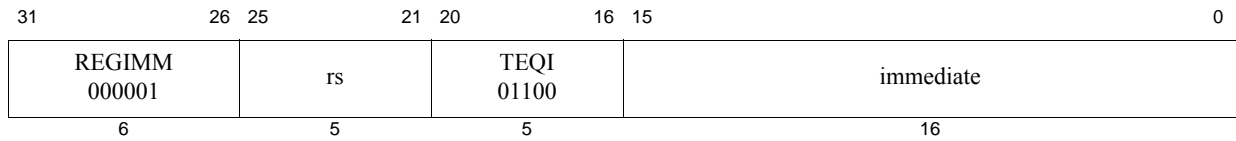

Format: TEQI *rs*, *immediate*

MIPS32, removed in Release 6

Purpose: Trap if Equal Immediate

To compare a GPR to a constant and do a conditional trap.

Description: if GPR[*rs*] = *immediate* then Trap

Compare the contents of GPR *rs* and the 16-bit signed *immediate* as signed integers. If GPR *rs* is equal to *immediate*, then take a Trap exception.

Restrictions:

None

Availability and Compatibility:

This instruction has been removed in Release 6.

Operation:

```
if GPR[rs] = sign_extend(immediate) then
    SignalException(Trap)
endif
```

Exceptions:

Trap

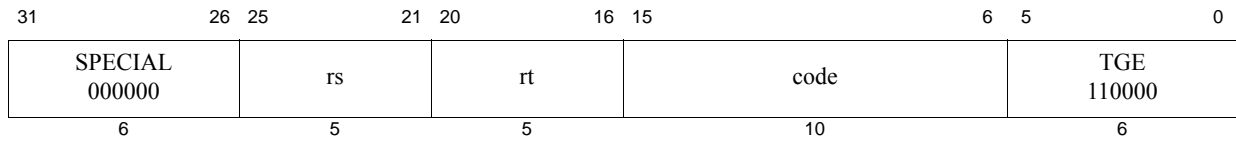

Format: TGE *rs*, *rt*

MIPS32

Purpose: Trap if Greater or Equal

To compare GPRs and do a conditional trap.

Description: if $GPR[rs] \geq GPR[rt]$ then Trap

Compare the contents of GPR *rs* and GPR *rt* as signed integers. If GPR *rs* is greater than or equal to GPR *rt*, then take a Trap exception.

The contents of the *code* field are ignored by hardware and may be used to encode information for system software. To retrieve the information, the system software may load the instruction word from memory. Optionally, if COP0 *BadInstr* is implemented, the *code* field may be obtained from *BadInstr*.

Restrictions:

None

Operation:

```
if GPR[rs] ≥ GPR[rt] then
    SignalException(Trap)
endif
```

Exceptions:

Trap

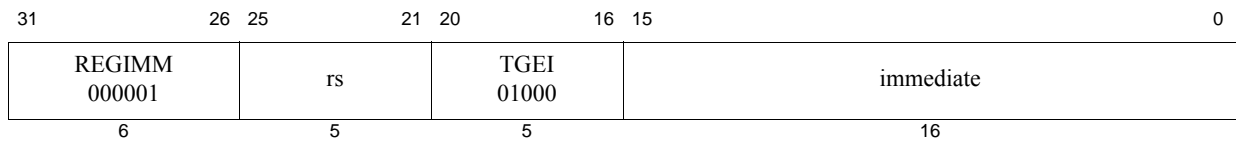

Format: TGEI *rs*, *immediate*

MIPS32, removed in Release 6

Purpose: Trap if Greater or Equal Immediate

To compare a GPR to a constant and do a conditional trap.

Description: if $GPR[rs] \geq immediate$ then Trap

Compare the contents of GPR *rs* and the 16-bit signed *immediate* as signed integers. If GPR *rs* is greater than or equal to *immediate*, then take a Trap exception.

Restrictions:

None

Availability and Compatibility:

This instruction has been removed in Release 6.

Operation:

```
if GPR[rs] ≥ sign_extend(immediate) then
    SignalException(Trap)
endif
```

Exceptions:

Trap

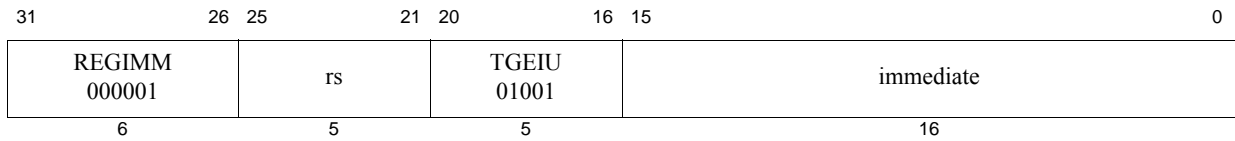

Format: TGEIU *rs*, *immediate*

MIPS32, removed in Release 6

Purpose: Trap if Greater or Equal Immediate Unsigned

To compare a GPR to a constant and do a conditional trap.

Description: if $GPR[rs] \geq \text{immediate}$ then Trap

Compare the contents of GPR *rs* and the 16-bit sign-extended *immediate* as unsigned integers. If GPR *rs* is greater than or equal to *immediate*, then take a Trap exception.

Because the 16-bit *immediate* is sign-extended before comparison, the instruction can represent the smallest or largest unsigned numbers. The representable values are at the minimum [0, 32767] or maximum [max_unsigned-32767, max_unsigned] end of the unsigned range.

Restrictions:

None

Availability and Compatibility:

This instruction has been removed in Release 6.

Operation:

```
if (0 || GPR[rs]) ≥ (0 || sign_extend(immediate)) then
    SignalException(Trap)
endif
```

Exceptions:

Trap

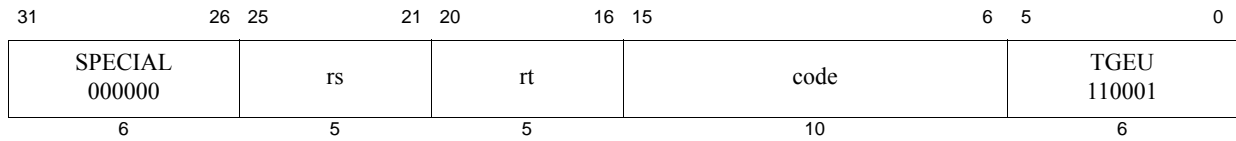

Format: TGEU *rs*, *rt*

MIPS32

Purpose: Trap if Greater or Equal Unsigned

To compare GPRs and do a conditional trap.

Description: if $GPR[rs] \geq GPR[rt]$ then Trap

Compare the contents of GPR *rs* and GPR *rt* as unsigned integers. If GPR *rs* is greater than or equal to GPR *rt*, then take a Trap exception.

The contents of the *code* field are ignored by hardware and may be used to encode information for system software. To retrieve the information, the system software may load the instruction word from memory. Optionally, if COP0 *BadInstr* is implemented, the *code* field may be obtained from *BadInstr*.

Restrictions:

None

Operation:

```
if (0 || GPR[rs]) ≥ (0 || GPR[rt]) then
    SignalException(Trap)
endif
```

Exceptions:

Trap

31	26	25	24	6	5	0
COP0 010000	CO 1	0 000 0000 0000 0000 0000			TLBINV 000011	
6	1	19			6	

Format: TLBINV

MIPS32

Purpose: TLB Invalidate

TLBINV invalidates a set of TLB entries based on ASID and Index match. The virtual address is ignored in the entry match. TLB entries which have their G bit set to 1 are not modified.

Implementation of the TLBINV instruction is optional. The implementation of this instruction is indicated by the IE field in *Config4*.

Support for TLBINV is recommend for implementations supporting VTLB/FTLB type of MMU.

Implementation of *EntryHI_{EHINV}* field is required for implementation of TLBINV instruction.

Description:

On execution of the TLBINV instruction, the set of TLB entries with matching ASID are marked invalid, excluding those TLB entries which have their G bit set to 1.

The *EntryHI_{ASID}* field has to be set to the appropriate ASID value before executing the TLBINV instruction.

Behavior of the TLBINV instruction applies to all applicable TLB entries and is unaffected by the setting of the *Wired* register.

- For JTLB-based MMU (*Config_{MT}*=1):

All matching entries in the JTLB are invalidated. The *Index* register is unused.

- For VTLB/FTLB -based MMU (*Config_{MT}*=4):

If TLB invalidate walk is implemented in software (*Config_{IE}*=2), then software must do these steps to flush the entire MMU:

1. one TLBINV instruction is executed with an index in VTLB range (invalidates all matching VTLB entries)
2. a TLBINV instruction is executed for each FTLB set (invalidates all matching entries in FTLB set)

If TLB invalidate walk is implemented in hardware (*Config_{IE}*=3), then software must do these steps to flush the entire MMU:

1. one TLBINV instruction is executed (invalidates all matching entries in both FTLB & VTLB). In this case, *Index* is unused.

Restrictions:

When *Config_{MT}* = 4 and *Config_{IE}* = 2, the operation is **UNDEFINED** if the contents of the *Index* register are greater than or equal to the number of available TLB entries.

If access to Coprocessor 0 is not enabled, a Coprocessor Unusable Exception is signaled.

Availability and Compatibility:

Implementation of the TLBINV instruction is optional. The implementation of this instruction is indicated by the IE

field in *Config4*.

Implementation of *EntryHi_{EHINV}* field is required for implementation of TLBINV instruction.

Pre-Release 6, support for TLBINV is recommended for implementations supporting VTLB/FTLB type of MMU. Release 6 (and subsequent releases) support for TLBINV is required for implementations supporting VTLB/FTLB type of MMU.

Release 6: On processors that include a Block Address Translation (BAT) or Fixed Mapping (FM) MMU (*Config_{MT}*= 2 or 3), the operation of this instruction causes a Reserved Instruction exception (RI).

Operation:

```

if ( ConfigMT=1 or (ConfigMT=4 & Config4IE=2 & Index < VTLBsize() ) )
    startnum ← 0
    endnum ← VTLBsize() - 1
endif
// treating VTLB and FTLB as one array
if (ConfigMT=4 & Config4IE=2 & Index ≥ VTLBsize(); )
    startnum ← start of selected FTLB set // implementation specific
    endnum ← end of selected FTLB set - 1 //implementation specific
endif

if (ConfigMT=4 & Config4IE=3)
    startnum ← 0
    endnum ← VTLBsize() + FTLBsize() - 1;
endif

for (i = startnum to endnum)
    if (TLB[i]ASID = EntryHiASID & TLB[i]G = 0)
        TLB[i]VPN2_invalid ← 1
    endif
endfor

function VTLBsize
    SizeExt = ArchRev() ≥ 6           ? Config4VTLBsizeExt
           : Config4MMUExtDef == 3    ? Config4VTLBsizeExt
           : Config4MMUExtDef == 1    ? Config4MMUsizeExt
           :                               0
    ;
    return 1 + ( (SizeExt << 6) | Config1MMUSize );
endfunction

function FTLBsize
    if ( Config1MT == 4 ) then
        return ( Config4FTLBways + 2 ) * ( 1 << C0_Config4FTLBsets );
    else
        return 0;
    endif
endfunction

```

Exceptions:

Coprocessor Unusable,

31	26	25	24	6	5	0
COP0 010000	CO 1	0 000 0000 0000 0000 0000			TLBINVF 000100	
6	1	19			6	

Format: TLBINVF

MIPS32

Purpose: TLB Invalidate Flush

TLBINVF invalidates a set of TLB entries based on *Index* match. The virtual address and ASID are ignored in the entry match.

Implementation of the TLBINVF instruction is optional. The implementation of this instruction is indicated by the IE field in *Config4*.

Support for TLBINVF is recommend for implementations supporting VTLB/FTLB type of MMU.

Implementation of the *EntryHl_{EHINV}* field is required for implementation of TLBINV and TLBINVF instructions.

Description:

On execution of the TLBINVF instruction, all entries within range of *Index* are invalidated.

Behavior of the TLBINVF instruction applies to all applicable TLB entries and is unaffected by the setting of the *Wired* register.

- For JTLB-based MMU (*Config_{MT}*=1):

TLBINVF causes all entries in the JTLB to be invalidated. *Index* is unused.

- For VTLB/FTLB-based MMU (*Config_{MT}*=4):

If TLB invalidate walk is implemented in your software (*Config_{IE}*=2), then your software must do these steps to flush the entire MMU:

- one TLBINVF instruction is executed with an index in VTLB range (invalidates all VTLB entries)
- a TLBINVF instruction is executed for each FTLB set (invalidates all entries in FTLB set)

If TLB invalidate walk is implemented in hardware (*Config_{IE}*=3), then software must do these steps to flush the entire MMU:

- one TLBINVF instruction is executed (invalidates all entries in both FTLB & VTLB). In this case, *Index* is unused.

Restrictions:

When *Config_{MT}*=4 and *Config_{IE}*=2, the operation is **UNDEFINED** if the contents of the *Index* register are greater than or equal to the number of available TLB entries.

If access to Coprocessor 0 is not enabled, a Coprocessor Unusable Exception is signaled.

Availability and Compatibility:

Implementation of the TLBINVF instruction is optional. The implementation of this instruction is indicated by the IE field in *Config4*.

Implementation of *EntryHl_{EHINV}* field is required for implementation of TLBINVF instruction.

Pre-Release 6, support for TLBINVF is recommended for implementations supporting VTLB/FTLB type of MMU. Release 6 (and subsequent releases) support for TLBINV is required for implementations supporting VTLB/FTLB type of MMU.

Release 6: On processors that include a Block Address Translation (BAT) or Fixed Mapping (FM) MMU ($Config_{MT}=2$ or 3), the operation of this instruction causes a Reserved Instruction exception (RI).

Operation:

```

if ( ConfigMT=1 or (ConfigMT=4 & Config4IE=2 & Index < VTLBsize() ))
    startnum ← 0
    endnum ← VTLBsize() - 1
endif
// treating VTLB and FTLB as one array
if (ConfigMT=4 & Config4IE=2 & Index ≥ VTLBsize(); )
    startnum ← start of selected FTLB set // implementation specific
    endnum ← end of selected FTLB set - 1 //implementation specific
endif

if (ConfigMT=4 & Config4IE=3)
    startnum ← 0
    endnum ← TLBsize() + FTLBsize() - 1;
endif

for (i = startnum to endnum)
    TLB[i]VPN2_invalid ← 1
endfor

function VTLBsize
    SizeExt = ArchRev() ≥ 6           ? Config4VTLBSizeExt
        : Config4MMUExtDef == 3       ? Config4VTLBSizeExt
        : Config4MMUExtDef == 1       ? Config4MMUSizeExt
        :                               0
    ;
    return 1 + ( (SizeExt << 6) | Config1MMUSize );
endfunction

function FTLBsize
    if ( Config1MT == 4 ) then
        return ( Config4FTLBWays + 2 ) * ( 1 << C0_Config4FTLBsets );
    else
        return 0;
    endif
endfunction

```

Exceptions:

Coprocessor Unusable,

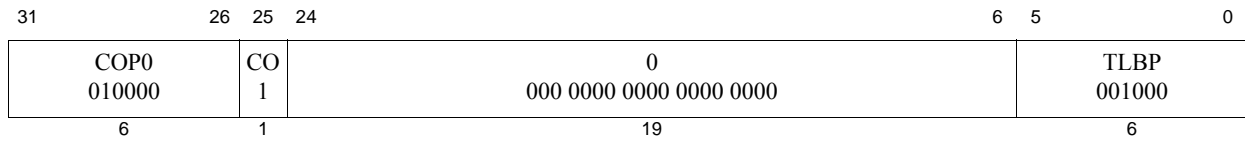

Format: TLBP

MIPS32

Purpose: Probe TLB for Matching Entry

To find a matching entry in the TLB.

Description:

The *Index* register is loaded with the address of the TLB entry whose contents match the contents of the *EntryHi* register. If no TLB entry matches, the high-order bit of the *Index* register is set.

- In Release 1 of the Architecture, it is implementation dependent whether multiple TLB matches are detected on a TLBP. However, implementations are strongly encouraged to report multiple TLB matches only on a TLB write.
- In Release 2 of the Architecture, multiple TLB matches may only be reported on a TLB write.
- In Release 3 of the Architecture, multiple TLB matches may be reported on either TLB write or TLB probe.

Restrictions:

If access to Coprocessor 0 is not enabled, a Coprocessor Unusable Exception is signaled.

Release 6: Processors that include a Block Address Translation (BAT) or Fixed Mapping (FM) MMU (*Config_{MT}* = 2 or 3), the operation of this instruction causes a Reserved Instruction exception (RI).

Operation:

```

Index ← 1 || UNPREDICTABLE31
for i in 00 ... TLBEntries-1
  if ((TLB[i]VPN2 and not (TLB[i]Mask)) =
      (EntryHiVPN2 and not (TLB[i]Mask))) and
      ((TLB[i]G = 1) or (TLB[i]ASID = EntryHiASID)) then
    Index ← i
  endif
endfor

```

Exceptions:

Coprocessor Unusable, Machine Check

31	26	25	24	6	5	0
COP0 010000	CO 1	0 000 0000 0000 0000 0000			TLBR 000001	
6	1	19			6	

Format: TLBR

MIPS32

Purpose: Read Indexed TLB Entry

To read an entry from the TLB.

Description:

The *EntryHi*, *EntryLo0*, *EntryLo1*, and *PageMask* registers are loaded with the contents of the TLB entry pointed to by the *Index* register.

- In Release 1 of the Architecture, it is implementation dependent whether multiple TLB matches are detected on a TLBR. However, implementations are strongly encouraged to report multiple TLB matches only on a TLB write.
- In Release 2 of the Architecture, multiple TLB matches may only be reported on a TLB write.
- In Release 3 of the Architecture, multiple TLB matches may be detected on a TLBR.

In an implementation supporting TLB entry invalidation ($Config4_{IE} \geq 1$), reading an invalidated TLB entry causes *EntryLo0* and *EntryLo1* to be set to 0, *EntryHi*_{EHINV} to be set to 1, all other *EntryHi* bits to be set to 0, and *PageMask* to be set to a value representing the minimum supported page size..

The value written to the *EntryHi*, *EntryLo0*, and *EntryLo1* registers may be different from the original written value to the TLB via these registers in that:

- The value returned in the *VPN2* field of the *EntryHi* register may have those bits set to zero corresponding to the one bits in the Mask field of the TLB entry (the least-significant bit of *VPN2* corresponds to the least-significant bit of the Mask field). It is implementation dependent whether these bits are preserved or zeroed after a TLB entry is written and then read.
- The value returned in the *PFN* field of the *EntryLo0* and *EntryLo1* registers may have those bits set to zero corresponding to the one bits in the Mask field of the TLB entry (the least significant bit of *PFN* corresponds to the least significant bit of the Mask field). It is implementation dependent whether these bits are preserved or zeroed after a TLB entry is written and then read.
- The value returned in the *G* bit in both the *EntryLo0* and *EntryLo1* registers comes from the single *G* bit in the TLB entry. Recall that this bit was set from the logical AND of the two *G* bits in *EntryLo0* and *EntryLo1* when the TLB was written.

Restrictions:

The operation is **UNDEFINED** if the contents of the *Index* register are greater than or equal to the number of TLB entries in the processor.

If access to Coprocessor 0 is not enabled, a Coprocessor Unusable Exception is signaled.

Release 6: Processors that include a Block Address Translation (BAT) or Fixed Mapping (FM) MMU ($Config_{MT} = 2$ or 3), the operation of this instruction causes a Reserved Instruction exception (RI).

Operation:

```

i ← Index
if i > (TLBEntries - 1) then
    UNDEFINED
endif

```



```

if ( (Config4IB ≥ 1) and TLB[i]VPN2_invalid = 1) then
  PagemaskMask ← 0 // or value representing minimum page size
  EntryHi ← 0
  EntryLo1 ← 0
  EntryLo0 ← 0
  EntryHiEHINV ← 1
else
  PageMaskMask ← TLB[i]Mask
  EntryHi ←
    (TLB[i]VPN2 and not TLB[i]Mask) || # Masking implem dependent
    05 || TLB[i]ASID
  EntryLo1 ← 02 ||
    (TLB[i]PFN1 and not TLB[i]Mask) || # Masking mplem dependent
    TLB[i]C1 || TLB[i]D1 || TLB[i]V1 || TLB[i]G
  EntryLo0 ← 02 ||
    (TLB[i]PFN0 and not TLB[i]Mask) || # Masking mplem dependent
    TLB[i]C0 || TLB[i]D0 || TLB[i]V0 || TLB[i]G
endif

```

Exceptions:

Coprocessor Unusable, Machine Check

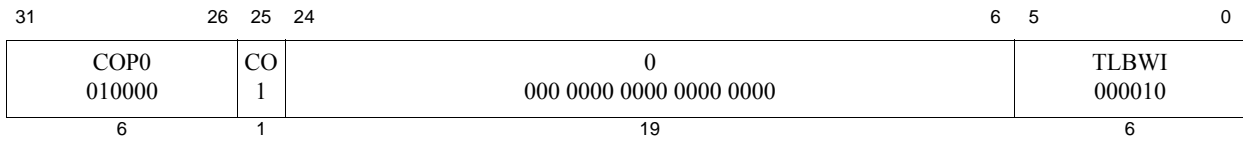

Format: TLBWI

MIPS32

Purpose: Write Indexed TLB Entry

To write or invalidate a TLB entry indexed by the *Index* register.

Description:

If $Config4_{IE} == 0$ or $EntryHi_{EHINV} = 0$:

The TLB entry pointed to by the Index register is written from the contents of the *EntryHi*, *EntryLo0*, *EntryLo1*, and *PageMask* registers. It is implementation dependent whether multiple TLB matches are detected on a TLBWI. In such an instance, a Machine Check Exception is signaled.

In Release 2 of the Architecture, multiple TLB matches may only be reported on a TLB write. The information written to the TLB entry may be different from that in the *EntryHi*, *EntryLo0*, and *EntryLo1* registers, in that:

- The value written to the VPN2 field of the TLB entry may have those bits set to zero corresponding to the one bits in the Mask field of the *PageMask* register (the least significant bit of VPN2 corresponds to the least significant bit of the Mask field). It is implementation dependent whether these bits are preserved or zeroed during a TLB write.
- The value written to the PFN0 and PFN1 fields of the TLB entry may have those bits set to zero corresponding to the one bits in the Mask field of *PageMask* register (the least significant bit of PFN corresponds to the least significant bit of the Mask field). It is implementation dependent whether these bits are preserved or zeroed during a TLB write.
- The single G bit in the TLB entry is set from the logical AND of the G bits in the *EntryLo0* and *EntryLo1* registers.

If $Config4_{IE} \geq 1$ and $EntryHi_{EHINV} = 1$:

The TLB entry pointed to by the Index register has its VPN2 field marked as invalid. This causes the entry to be ignored on TLB matches for memory accesses. No Machine Check is generated.

Restrictions:

The operation is **UNDEFINED** if the contents of the Index register are greater than or equal to the number of TLB entries in the processor.

If access to Coprocessor 0 is not enabled, a Coprocessor Unusable Exception is signaled.

Release 6: Processors that include a Block Address Translation (BAT) or Fixed Mapping (FM) MMU ($Config_{MT} = 2$ or 3), the operation of this instruction causes a Reserved Instruction exception (RI).

Operation:

```

i ← Index
if (Config4IE ≥ 1) then
    TLB[i]VPN2_invalid ← 0
    if (EntryHIEHINV=1) then

```

```

        TLB[i]VPN2_invalid ← 1
        break
    endif
endif
TLB[i]Mask ← PageMaskMask
TLB[i]VPN2 ← EntryHiVPN2 and not PageMaskMask # Implementation dependent
TLB[i]ASID ← EntryHiASID
TLB[i]G ← EntryLo1G and EntryLo0G
TLB[i]PFN1 ← EntryLo1PFN and not PageMaskMask # Implementation dependent
TLB[i]C1 ← EntryLo1C
TLB[i]D1 ← EntryLo1D
TLB[i]V1 ← EntryLo1V
TLB[i]PFN0 ← EntryLo0PFN and not PageMaskMask # Implementation dependent
TLB[i]C0 ← EntryLo0C
TLB[i]D0 ← EntryLo0D
TLB[i]V0 ← EntryLo0V

```

Exceptions:

Coprocessor Unusable, Machine Check

31	26	25	24	6	5	0
COP0 010000	CO 1	0 000 0000 0000 0000 0000			TLBWR 000110	
6	1	19			6	

Format: TLBWR

MIPS32

Purpose: Write Random TLB Entry

To write a TLB entry indexed by the *Random* register, or, in Release 6, write a TLB entry indexed by an implementation-defined location.

Description:

The TLB entry pointed to by the *Random* register is written from the contents of the *EntryHi*, *EntryLo0*, *EntryLo1*, and *PageMask* registers. It is implementation dependent whether multiple TLB matches are detected on a TLBWR. In such an instance, a Machine Check Exception is signaled.

In Release 6, the *Random* register has been removed. References to *Random* refer to an implementation-determined value that is not visible to software.

In Release 2 of the Architecture, multiple TLB matches may only be reported on a TLB write. The information written to the TLB entry may be different from that in the *EntryHi*, *EntryLo0*, and *EntryLo1* registers, in that:

- The value written to the VPN2 field of the TLB entry may have those bits set to zero corresponding to the one bits in the Mask field of the *PageMask* register (the least significant bit of VPN2 corresponds to the least significant bit of the Mask field). It is implementation dependent whether these bits are preserved or zeroed during a TLB write.
- The value written to the PFN0 and PFN1 fields of the TLB entry may have those bits set to zero corresponding to the one bits in the Mask field of *PageMask* register (the least significant bit of PFN corresponds to the least significant bit of the Mask field). It is implementation dependent whether these bits are preserved or zeroed during a TLB write.
- The single G bit in the TLB entry is set from the logical AND of the G bits in the *EntryLo0* and *EntryLo1* registers.

Restrictions:

If access to Coprocessor 0 is not enabled, a Coprocessor Unusable Exception is signaled.

Release 6: Processors that include a Block Address Translation (BAT) or Fixed Mapping (FM) MMU ($Config_{MT} = 2$ or 3), the operation of this instruction causes a Reserved Instruction exception (RI).

Operation:

```

i ← Random
if (Config4IE ≥ 1) then
    TLB[i]VPN2_invalid ← 0
endif
TLB[i]Mask ← PageMaskMask
TLB[i]VPN2 ← EntryHiVPN2 and not PageMaskMask # Implementation dependent
TLB[i]ASID ← EntryHiASID
TLB[i]G ← EntryLo1G and EntryLo0G
TLB[i]PFN1 ← EntryLo1PFN and not PageMaskMask # Implementation dependent
TLB[i]C1 ← EntryLo1C
TLB[i]D1 ← EntryLo1D
TLB[i]V1 ← EntryLo1V
TLB[i]PFN0 ← EntryLo0PFN and not PageMaskMask # Implementation dependent

```

$$\begin{aligned} \text{TLB}[i]_{C0} &\leftarrow \text{EntryLo0}_C \\ \text{TLB}[i]_{D0} &\leftarrow \text{EntryLo0}_D \\ \text{TLB}[i]_{V0} &\leftarrow \text{EntryLo0}_V \end{aligned}$$
Exceptions:

Coprocessor Unusable, Machine Check

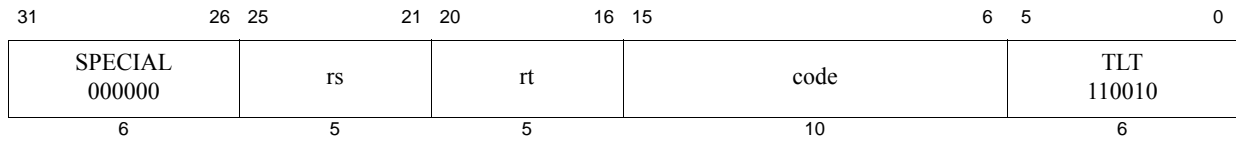

Format: TLT *rs*, *rt*

MIPS32

Purpose: Trap if Less Than

To compare GPRs and do a conditional trap.

Description: if GPR[*rs*] < GPR[*rt*] then Trap

Compare the contents of GPR *rs* and GPR *rt* as signed integers. If GPR *rs* is less than GPR *rt*, then take a Trap exception.

The contents of the *code* field are ignored by hardware and may be used to encode information for system software. To retrieve the information, system software must load the instruction word from memory.

Restrictions:

None

Operation:

```
if GPR[rs] < GPR[rt] then
    SignalException(Trap)
endif
```

Exceptions:

Trap

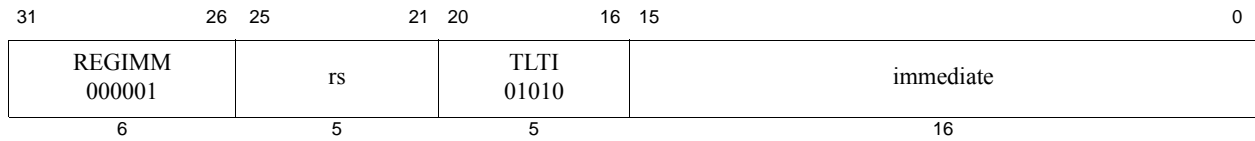

Format: TLTI *rs*, *immediate*

MIPS32, removed in Release 6

Purpose: Trap if Less Than Immediate

To compare a GPR to a constant and do a conditional trap.

Description: if `GPR[rs] < immediate` then Trap

Compare the contents of GPR *rs* and the 16-bit signed *immediate* as signed integers. If GPR *rs* is less than *immediate*, then take a Trap exception.

Restrictions:

None

Availability and Compatibility:

This instruction has been removed in Release 6.

Operation:

```
if GPR[rs] < sign_extend(immediate) then
    SignalException(Trap)
endif
```

Exceptions:

Trap

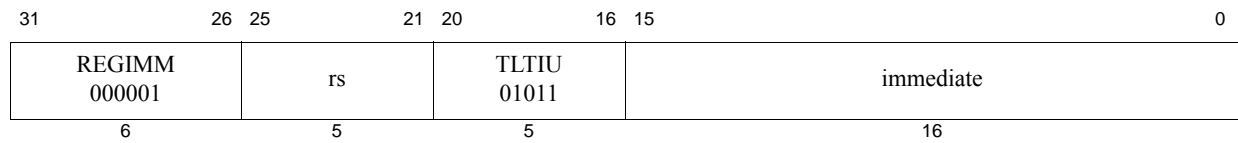

Format: TLTIU *rs*, *immediate*

MIPS32, removed in Release 6

Purpose: Trap if Less Than Immediate Unsigned

To compare a GPR to a constant and do a conditional trap.

Description: if `GPR[rs] < immediate` then Trap

Compare the contents of GPR *rs* and the 16-bit sign-extended *immediate* as unsigned integers. If GPR *rs* is less than *immediate*, then take a Trap exception.

Because the 16-bit *immediate* is sign-extended before comparison, the instruction can represent the smallest or largest unsigned numbers. The representable values are at the minimum [0, 32767] or maximum [max_unsigned-32767, max_unsigned] end of the unsigned range.

Restrictions:

None

Availability and Compatibility:

This instruction has been removed in Release 6.

Operation:

```
if (0 || GPR[rs]) < (0 || sign_extend(immediate)) then
    SignalException(Trap)
endif
```

Exceptions:

Trap

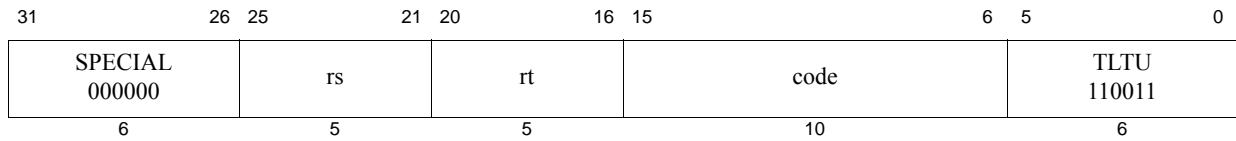

Format: TLTU *rs*, *rt*

MIPS32

Purpose: Trap if Less Than Unsigned

To compare GPRs and do a conditional trap.

Description: `if GPR[rs] < GPR[rt] then Trap`

Compare the contents of GPR *rs* and GPR *rt* as unsigned integers. If GPR *rs* is less than GPR *rt*, then take a Trap exception.

The contents of the *code* field are ignored by hardware and may be used to encode information for system software. To retrieve the information, system software must load the instruction word from memory.

Restrictions:

None

Operation:

```
if (0 || GPR[rs]) < (0 || GPR[rt]) then
    SignalException(Trap)
endif
```

Exceptions:

Trap

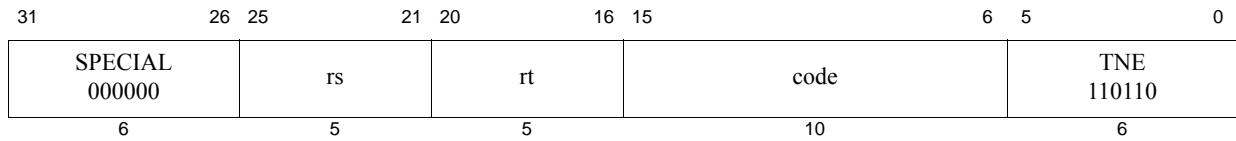

Format: TNE *rs*, *rt*

MIPS32

Purpose: Trap if Not Equal

To compare GPRs and do a conditional trap.

Description: if GPR[*rs*] \neq GPR[*rt*] then Trap

Compare the contents of GPR *rs* and GPR *rt* as signed integers. If GPR *rs* is not equal to GPR *rt*, then take a Trap exception.

The contents of the *code* field are ignored by hardware and may be used to encode information for system software. To retrieve the information, system software must load the instruction word from memory.

Restrictions:

None

Operation:

```
if GPR[rs]  $\neq$  GPR[rt] then
    SignalException(Trap)
endif
```

Exceptions:

Trap

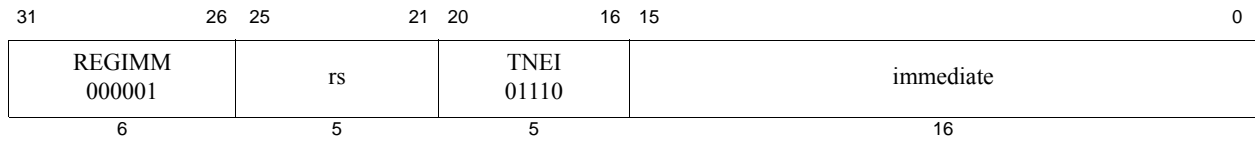

Format: TNEI rs, immediate

MIPS32, removed in Release 6

Purpose: Trap if Not Equal Immediate

To compare a GPR to a constant and do a conditional trap.

Description: if GPR[rs] \neq immediate then Trap

Compare the contents of GPR *rs* and the 16-bit signed *immediate* as signed integers. If GPR *rs* is not equal to *immediate*, then take a Trap exception.

Restrictions:

None

Availability and Compatibility:

This instruction has been removed in Release 6.

Operation:

```
if GPR[rs]  $\neq$  sign_extend(immediate) then
    SignalException(Trap)
endif
```

Exceptions:

Trap

31	26 25	21 20	16 15	11 10	6 5	0
COP1 010001	fmt	0 00000	fs	fd	TRUNC.L 001001	
6	5	5	5	5	6	

Format: TRUNC.L.fmt
 TRUNC.L.S fd, fs
 TRUNC.L.D fd, fs

MIPS64,MIPS32 Release 2
MIPS64,MIPS32 Release 2

Purpose: Floating Point Truncate to Long Fixed Point

To convert an FP value to 64-bit fixed point, rounding toward zero.

Description: $FPR[fd] \leftarrow \text{convert_and_round}(FPR[fs])$

The value in FPR *fs*, in format *fmt*, is converted to a value in 64-bit long-fixed point format and rounded toward zero (rounding mode 1). The result is placed in FPR *fd*.

When the source value is Infinity, NaN, or rounds to an integer outside the range -2^{63} to $2^{63}-1$, the result cannot be represented correctly and an IEEE Invalid Operation condition exists. In this case the Invalid Operation flag is set in the *FCSR*. If the Invalid Operation *Enable* bit is set in the *FCSR*, no result is written to *fd* and an Invalid Operation exception is taken immediately. Otherwise, a default result is written to *fd*. On cores with $FCSR_{NAN2008}=0$, the default result is $2^{63}-1$. On cores with $FCSR_{NAN2008}=1$, the default result is:

- 0 when the input value is NaN
- $2^{63}-1$ when the input value is $+\infty$ or rounds to a number larger than $2^{63}-1$
- $-2^{63}-1$ when the input value is $-\infty$ or rounds to a number smaller than $-2^{63}-1$

Restrictions:

The fields *fs* and *fd* must specify valid FPRs: *fs* for type *fmt* and *fd* for long fixed point. If the fields are not valid, the result is **UNPREDICTABLE**.

The operand must be a value in format *fmt*; if it is not, the result is **UNPREDICTABLE** and the value of the operand FPR becomes **UNPREDICTABLE**.

The result of this instruction is **UNPREDICTABLE** if the processor is executing in the $FR=0$ 32-bit FPU register model; it is predictable if executing on a 64-bit FPU in the $FR=1$ mode, but not with $FR=0$, and not on a 32-bit FPU.

Operation:

$\text{StoreFPR}(fd, L, \text{ConvertFmt}(\text{ValueFPR}(fs, fmt), fmt, L))$

Exceptions:

Coprocessor Unusable, Reserved Instruction

Floating Point Exceptions:

Unimplemented Operation, Invalid Operation, Inexact

31	26 25	21 20	16 15	11 10	6 5	0
COP1 010001	fmt	0 00000	fs	fd	TRUNC.W 001101	
6	5	5	5	5	6	

Format: TRUNC.W.fmt
 TRUNC.W.S fd, fs
 TRUNC.W.D fd, fs

MIPS32
MIPS32

Purpose: Floating Point Truncate to Word Fixed Point

To convert an FP value to 32-bit fixed point, rounding toward zero.

Description: $FPR[fd] \leftarrow \text{convert_and_round}(FPR[fs])$

The value in FPR *fs*, in format *fmt*, is converted to a value in 32-bit word fixed point format using rounding toward zero (rounding mode 1). The result is placed in FPR *fd*.

When the source value is Infinity, NaN, or rounds to an integer outside the range -2^{31} to $2^{31}-1$, the result cannot be represented correctly and an IEEE Invalid Operation condition exists. In this case the Invalid Operation flag is set in the *FCSR*. If the Invalid Operation *Enable* bit is set in the *FCSR*, no result is written to *fd* and an Invalid Operation exception is taken immediately. Otherwise, a default result is written to *fd*. On cores with $FCSR_{NAN2008}=0$, the default result is $2^{31}-1$. On cores with $FCSR_{NAN2008}=1$, the default result is:

- 0 when the input value is NaN
- $2^{31}-1$ when the input value is $+\infty$ or rounds to a number larger than $2^{31}-1$
- $-2^{31}-1$ when the input value is $-\infty$ or rounds to a number smaller than $-2^{31}-1$

Restrictions:

The fields *fs* and *fd* must specify valid FPRs: *fs* for type *fmt* and *fd* for word fixed point. If the fields are not valid, the result is **UNPREDICTABLE**.

The operand must be a value in format *fmt*; if it is not, the result is **UNPREDICTABLE** and the value of the operand FPR becomes **UNPREDICTABLE**.

Operation:

$\text{StoreFPR}(fd, W, \text{ConvertFmt}(\text{ValueFPR}(fs, fmt), fmt, W))$

Exceptions:

Coprocessor Unusable, Reserved Instruction

Floating Point Exceptions:

Inexact, Invalid Operation, Unimplemented Operation

31	26	25	24	6	5	0
COP0 010000	CO 1	Implementation-dependent code			WAIT 100000	
6	1	19			6	

Format: WAIT

MIPS32

Purpose: Enter Standby Mode

Wait for Event

Description:

The WAIT instruction performs an implementation-dependent operation, involving a lower power mode. Software may use the code bits of the instruction to communicate additional information to the processor. The processor may use this information as control for the lower power mode. A value of zero for code bits is the default and must be valid in all implementations.

The WAIT instruction is implemented by stalling the pipeline at the completion of the instruction and entering a lower power mode. The pipeline is restarted when an external event, such as an interrupt or external request occurs, and execution continues with the instruction following the WAIT instruction. It is implementation-dependent whether the pipeline restarts when a non-enabled interrupt is requested. In this case, software must poll for the cause of the restart. The assertion of any reset or NMI must restart the pipeline and the corresponding exception must be taken.

If the pipeline restarts as the result of an enabled interrupt, that interrupt is taken between the WAIT instruction and the following instruction (EPC for the interrupt points at the instruction following the WAIT instruction).

In Release 6, the behavior of WAIT has been modified to make it a requirement that a processor that has disabled operation as a result of executing a WAIT will resume operation on arrival of an interrupt even if interrupts are not enabled.

In Release 6, the encoding of WAIT with bits 24:6 of the opcode set to 0 will never disable COP0 *Count* on an active WAIT instruction. In particular, this modification has been added to architecturally specify that COP0 *Count* is not disabled on execution of WAIT with default code of 0. Prior to Release 6, whether *Count* is disabled was implementation-dependent. In the future, other encodings of WAIT may be defined which specify other forms of power-saving or stand-by modes. If not implemented, then such unimplemented encodings must default to WAIT 0.

Restrictions:

Pre-Release 6: The operation of the processor is **UNDEFINED** if a WAIT instruction is executed in the delay slot of a branch or jump instruction.

Release 6: Implementations are required to signal a Reserved Instruction exception if WAIT is encountered in the delay slot or forbidden slot of a branch or jump instruction.

If access to Coprocessor 0 is not enabled, a Coprocessor Unusable Exception is signaled.

Operation:

Pre-Release 6:

```
I: Enter implementation dependent lower power mode
I+1:/* Potential interrupt taken here */
```

Release 6:

```
I: if IsCoproprocessorEnabled(0) then
    while ( !interrupt_pending_and_not_masked_out() &&
            !implementation_dependent_wake_event() )
        < enter or remain in low power mode or stand-by mode >
```

```

    else
        SignalException(CoprocessorUnusable, 0)
    endif

I+1:  if ( interrupt_pending() && interrupts_enabled() ) then
        EPC ← PC + 4
        < process interrupt; execute ERET eventually >
    else
        // unblock on non-enabled interrupt or imp dep wake event.
        PC ← PC + 4
        < continue execution at instruction after wait >
    endif

function interrupt_pending_and_not_masked_out
    return (Config3_VECTC && IntCtl_VS && Cause_IV && !Status_BEV)
           ? Cause_RIPL > Status_IPL : Cause_IP & Status_IM;
endfunction

function interrupts_enabled
    return Status_IE && !Status_EXL && !Status_ERL && !Debug_DM;
endfunction

function implementation_dependent_wake_event
    <return true if implementation dependent waking-up event occurs>
endfunction

```

Exceptions:

Coprocessor Unusable Exception

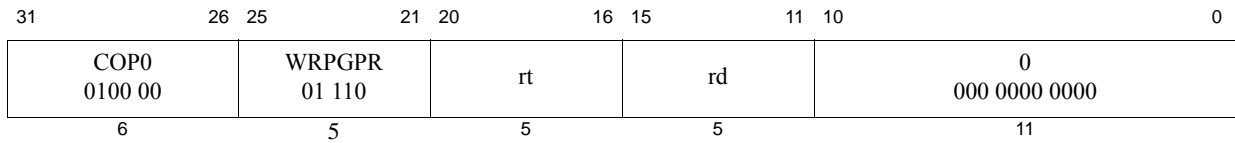

Format: WRPGPR rd, rt

MIPS32 Release 2

Purpose: Write to GPR in Previous Shadow Set

To move the contents of a current GPR to a GPR in the previous shadow set.

Description: $SGPR[SRSCtl_{pSS}, rd] \leftarrow GPR[rt]$

The contents of the current GPR *rt* is moved to the shadow GPR register specified by $SRSCtl_{pSS}$ (signifying the previous shadow set number) and *rd* (specifying the register number within that set).

Restrictions:

In implementations prior to Release 2 of the Architecture, this instruction resulted in a Reserved Instruction exception.

Operation:

$SGPR[SRSCtl_{pSS}, rd] \leftarrow GPR[rt]$

Exceptions:

Coprocessor Unusable, Reserved Instruction

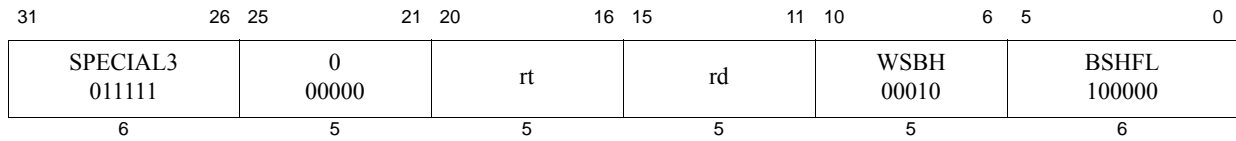

Format: WSBH rd, rt

MIPS32 Release 2

Purpose: Word Swap Bytes Within Halfwords

To swap the bytes within each halfword of GPR *rt* and store the value into GPR *rd*.

Description: $GPR[rd] \leftarrow \text{SwapBytesWithinHalfwords}(GPR[rt])$

Within each halfword of GPR *rt* the bytes are swapped, and stored in GPR *rd*.

Restrictions:

In implementations prior to Release 2 of the architecture, this instruction resulted in a Reserved Instruction exception.

Operation:

$$GPR[rd] \leftarrow GPR[r]_{23..16} \parallel GPR[r]_{31..24} \parallel GPR[r]_{7..0} \parallel GPR[r]_{15..8}$$

Exceptions:

Reserved Instruction

Programming Notes:

The WSBH instruction can be used to convert halfword and word data of one endianness to another endianness. The endianness of a word value can be converted using the following sequence:

```
lw    t0, 0(a1)          /* Read word value */
wsbh  t0, t0             /* Convert endiannes of the halfwords */
rotr  t0, t0, 16        /* Swap the halfwords within the words */
```

Combined with SEH and SRA, two contiguous halfwords can be loaded from memory, have their endianness converted, and be sign-extended into two word values in four instructions. For example:

```
lw    t0, 0(a1)          /* Read two contiguous halfwords */
wsbh  t0, t0             /* Convert endiannes of the halfwords */
seh   t1, t0             /* t1 = lower halfword sign-extended to word */
sra   t0, t0, 16        /* t0 = upper halfword sign-extended to word */
```

Zero-extended words can be created by changing the SEH and SRA instructions to ANDI and SRL instructions, respectively.

31	26 25	21 20	16 15	11 10	6 5	0
SPECIAL 000000	rs	rt	rd	0 00000	XOR 100110	
6	5	5	5	5	6	

Format: XOR rd, rs, rt

MIPS32

Purpose: Exclusive OR

To do a bitwise logical Exclusive OR.

Description: $GPR[rd] \leftarrow GPR[rs] \text{ XOR } GPR[rt]$

Combine the contents of GPR *rs* and GPR *rt* in a bitwise logical Exclusive OR operation and place the result into GPR *rd*.

Restrictions:

None

Operation:

$GPR[rd] \leftarrow GPR[rs] \text{ xor } GPR[rt]$

Exceptions:

None

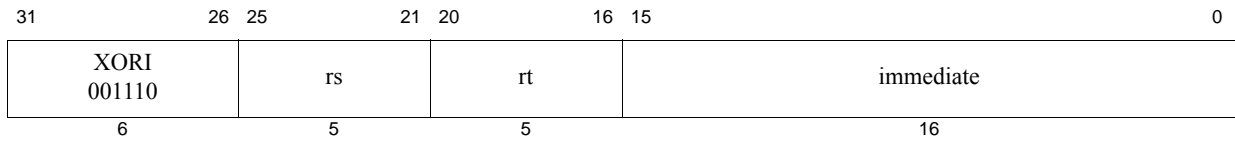

Format: XORI *rt*, *rs*, *immediate*

MIPS32

Purpose: Exclusive OR Immediate

To do a bitwise logical Exclusive OR with a constant.

Description: $GPR[rt] \leftarrow GPR[rs] \text{ XOR } immediate$

Combine the contents of GPR *rs* and the 16-bit zero-extended *immediate* in a bitwise logical Exclusive OR operation and place the result into GPR *rt*.

Restrictions:

None

Operation:

$GPR[rt] \leftarrow GPR[rs] \text{ xor } zero_extend(immediate)$

Exceptions:

None

Instruction Bit Encodings

A.1 Instruction Encodings and Instruction Classes

Instruction encodings are presented in this section; field names are printed here and throughout the book in *italics*.

When encoding an instruction, the primary *opcode* field is encoded first. Most *opcode* values completely specify an instruction that has an *immediate* value or offset.

Opcode values that do not specify an instruction instead specify an instruction class. Instructions within a class are further specified by values in other fields. For instance, *opcode* REGIMM specifies the *immediate* instruction class, which includes conditional branch and trap *immediate* instructions.

A.2 Instruction Bit Encoding Tables

This section provides various bit encoding tables for the instructions of the MIPS32® ISA.

Figure A.1 shows a sample encoding table and the instruction *opcode* field this table encodes. Bits 31..29 of the *opcode* field are listed in the leftmost columns of the table. Bits 28..26 of the *opcode* field are listed along the topmost rows of the table. Both decimal and binary values are given, with the first three bits designating the row, and the last three bits designating the column.

An instruction's encoding is found at the intersection of a row (bits 31..29) and column (bits 28..26) value. For instance, the *opcode* value for the instruction labeled EX1 is 33 (decimal, row and column), or 011011 (binary). Similarly, the *opcode* value for EX2 is 64 (decimal), or 110100 (binary).

Release 6 introduces additional nomenclature to the opcode tables for Release 6 instructions. For new instructions, bits 31:26 are generically named POPXY where X is the row number, and Y is the column number. This convention is extended to sub-opcode tables, except bits 5:0 are generically named SOPXY, where X is the row number, and Y is the column number. This naming convention is applied where a specific encoded value may be shared by multiple instructions.

Figure A.1 Sample Bit Encoding Table

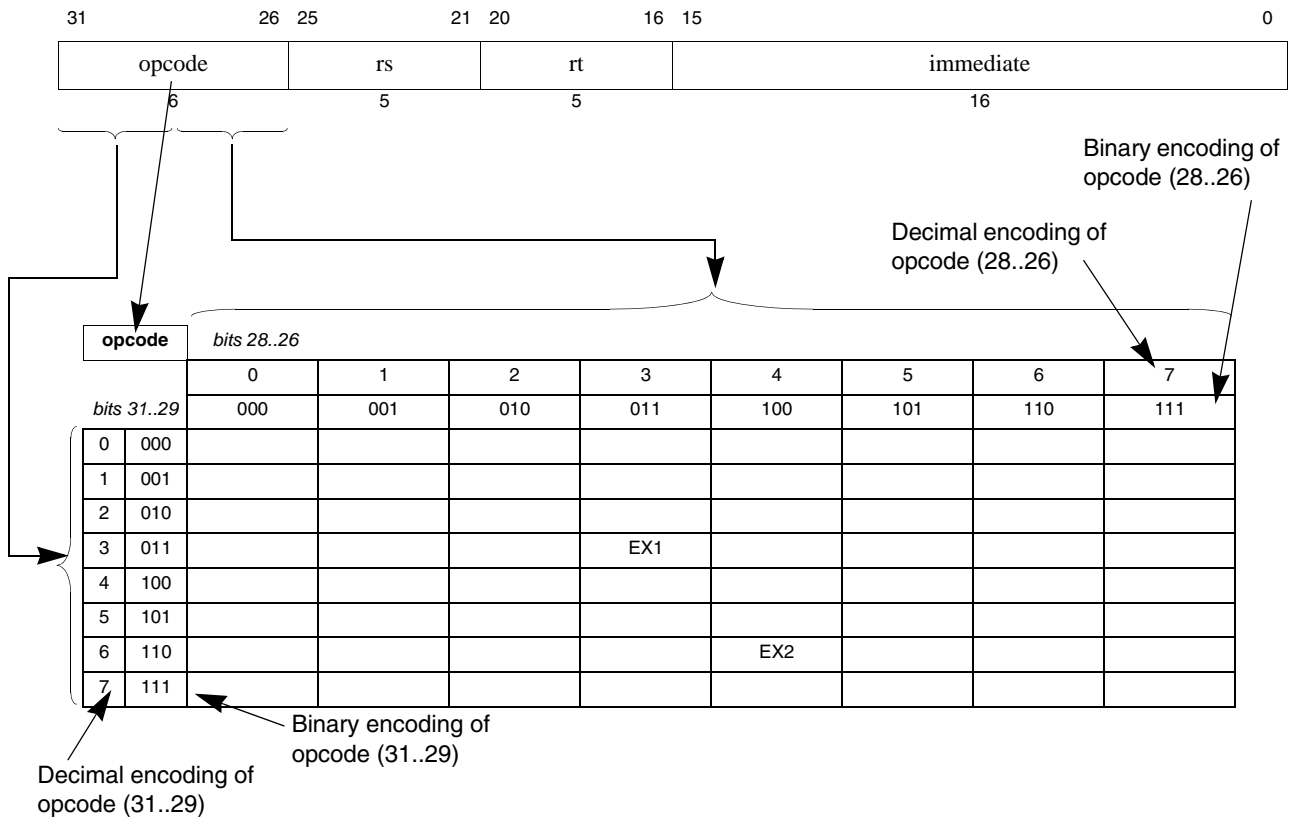

Tables A.2 through A.21 describe the encoding used for the MIPS32 ISA. Table A.1 describes the meaning of the symbols used in the tables.

Table A.1 Symbols Used in the Instruction Encoding Tables

Symbol	Meaning
*	Operation or field codes marked with this symbol are reserved for future use. Executing such an instruction must cause a Reserved Instruction exception. Note: Some instruction encodings are assigned to coprocessors (as indicated by COP0 or COP1 in the encoding table titles). For such instruction encodings, the Coprocessor Unavailable exception takes priority over the Reserved Instruction exception.
no marking	Many instructions are optional, or available only in certain configurations. As of Release 6, if a table entry would be empty in a particular configuration, then implementations are required to signal a Reserved Instruction exception when executed. Pre-Release 6 signalling a reserved instruction was not necessarily required, hence symbols such as * ⊥ ∇ Δ which indicate when such signalling is required or present, and when not. In other words, as of Release 6 full instruction decoding, including detection of unused instructions, is assumed as the default.
δ	(Also <i>italic</i> field name.) Operation or field codes marked with this symbol denotes a field class. The instruction word must be further decoded by examining additional tables that show values for another instruction field.
β	Operation or field codes marked with this symbol represent a valid encoding for a higher-order MIPS ISA level or a new revision of the Architecture. Executing such an instruction must cause a Reserved Instruction exception.

Table A.1 Symbols Used in the Instruction Encoding Tables (Continued)

Symbol	Meaning
∇	Operation or field codes marked with this symbol represent instructions which were only legal if 64-bit operations were enabled on implementations of Release 1 of the Architecture. In Release 2 of the architecture, operation or field codes marked with this symbol represent instructions which are legal if 64-bit floating point operations are enabled. In other cases, executing such an instruction must cause a Reserved Instruction exception (non-coprocessor encodings or coprocessor instruction encodings for a coprocessor to which access is allowed) or a Coprocessor Unusable Exception (coprocessor instruction encodings for a coprocessor to which access is not allowed).
Δ	Instructions formerly marked ∇ in some earlier versions of manuals, corrected and marked Δ in revision 5.03. Legal on MIPS64r1 but not MIPS32r1; in release 2 and above, legal in both MIPS64 and MIPS32, in particular even when running in “32-bit FPU Register File mode”, FR=0, as well as FR=1.
θ	Operation or field codes marked with this symbol are available to licensed MIPS partners. To avoid multiple conflicting instruction definitions, MIPS Technologies will assist the partner in selecting appropriate encodings if requested by the partner. The partner is not required to consult with MIPS Technologies when one of these encodings is used. If no instruction is encoded with this value, executing such an instruction must cause a Reserved Instruction exception (<i>SPECIAL2</i> encodings or coprocessor instruction encodings for a coprocessor to which access is allowed) or a Coprocessor Unusable Exception (coprocessor instruction encodings for a coprocessor to which access is not allowed).
θ^*	Release 6 reserves the <i>SPECIAL2</i> encodings. pre-MIPS32 Release 2 the <i>SPECIAL2</i> encodings were available for customer use as UDIs. Otherwise like θ above.
σ	Field codes marked with this symbol represent an EJTAG support instruction and implementation of this encoding is optional for each implementation. If the encoding is not implemented, executing such an instruction must cause a Reserved Instruction exception. If the encoding is implemented, it must match the instruction encoding as shown in the table.
ε	Operation or field codes marked with this symbol are reserved for MIPS optional Module or Application Specific Extensions. If the Module/ASE is not implemented, executing such an instruction must cause a Reserved Instruction exception.
ϕ	Operation or field codes marked with this symbol are obsolete and will be removed from a future revision of the MIPS32 ISA. Software should avoid using these operation or field codes.
\oplus	Operation or field codes marked with this symbol are valid for Release 2 implementations of the architecture. Executing such an instruction in a Release 1 implementation must cause a Reserved Instruction exception.
6N	Instruction added by Release 6. “N” for “new”.
6Nm	New Release 6 encoding for a pre-Release 6 instruction that has been moved. “Nm” for “New (moved)”

Table A.1 Symbols Used in the Instruction Encoding Tables (Continued)

Symbol	Meaning	
6Rm	pre-Release 6 instruction encoding moved in Release 6. “Rm” for “Removed (moved elsewhere)”.	6Rm and 6R instructions signal a Reserved Instruction exception when executed by a Release 6 implementation. If the encoding has been used for a new instruction or coprocessor, the unusable exception takes priority.
6R	pre-Release 6 instruction encoding removed by Release 6. “R” for “Removed”.	

Table A.2 MIPS32 Encoding of the Opcode Field

opcode		bits 28..26							
		0	1	2	3	4	5	6	7
bits 31..29		000	001	010	011	100	101	110	111
0	000	<i>SPECIAL</i> δ	<i>REGIMM</i> δ	J	JAL	BEQ	BNE	BLEZ POP06 ^{6N} δ	BGTZ POP07 ^{6N} δ
1	001	ADDI ^{6R} POP10 ^{6N} δ	ADDIU	SLTI	SLTIU	ANDI	ORI	XORI	LUI ¹ / AUI ^{6N}
2	010	<i>COP0</i> δ	<i>COP1</i> δ	<i>COP2</i> $\theta\delta$	<i>COP1X</i> ² δ ^{6R}	BEQL ^{6R} ϕ	BNEL ^{6R} ϕ	BLEZL ^{6R} ϕ POP26 ^{6N} δ	BGTZL ^{6R} ϕ POP27 ^{6N} δ
3	011	β POP30 ^{6N} δ	β	β	β	<i>SPECIAL2</i> ^{6R} δ θ^*	JALX ^{6R} ϵ	<i>MSA</i> $\epsilon\delta$	<i>SPECIAL3</i> ³ $\delta\oplus$
4	100	LB	LH	LWL ^{6R}	LW	LBU	LHU	LWR ^{6R}	β
5	101	SB	SH	SWL ^{6R}	SW	β	β	SWR ^{6R}	CACHE ^{6Rm}
6	110	LL ^{6Rm}	LWC1	LWC2 ^{6Rm} θ BC ^{6N}	PREF ^{6Rm}	β	LDC1	LDC2 ^{6Rm} θ BEQZC/JIC ^{6N} POP66 ^{6N} δ	β
7	111	SC ^{6Rm}	SWC1	SWC2 ^{6Rm} θ BALC ^{6N} δ	PCREL ^{6N}	β	SDC1	SDC2 ^{6Rm} θ BNEZC/JIALC ^{6N} POP76 ^{6N} δ	β

1. Pre-Release 6 instruction LUI is a special case of Release 6 instruction AUI.
2. Architecture Release 1, the COP1X opcode was called COP3, and was available as another user-available coprocessor. Architecture Release 2, a full 64-bit floating point unit is available with 32-bit CPUs, and the COP1X opcode is reserved for that purpose on all Release 2 CPUs. 32-bit implementations of Release 1 of the architecture are strongly discouraged from using this opcode for a user-available coprocessor as doing so limits the potential for an upgrade path for the FPU.
3. Architecture Release 2 added the SPECIAL3 opcode. Implementations of Release 1 of the Architecture signaled a Reserved Instruction exception for this opcode.

Table A.3 MIPS32 SPECIAL Opcode Encoding of Function Field

function		bits 2..0							
		0	1	2	3	4	5	6	7
bits 5..3		000	001	010	011	100	101	110	111
0	000	SLL ¹	MOVC ¹ ^{6R} _δ	SRL _δ	SRA	SLLV	LSA ^{6N}	SRLV _δ	SRAV
1	001	JR ^{2,3,6R}	JALR ²	MOVZ ^{6R}	MOVN ^{6R}	SYSCALL	BREAK	SDBBP ^{6Nm}	SYNC
2	010	MFHI ^{6R} CLZ ^{6Nm}	MTHI ^{6R} CLO ^{6Nm}	MFLO ^{6R}	MTLO ^{6R}	β	β	β	β
3	011 ⁴	⁴ MULT ^{6R} SOP30 ^{6N}	⁴ MULTU ^{6R} SOP31 ^{6N}	⁴ DIV ^{6R} SOP32 ^{6N}	⁴ DIVU ^{6R} SOP33 ^{6N}	β	β	β	β
4	100	ADD	ADDU	SUB	SUBU	AND	OR	XOR	NOR
5	101	*	*	SLT	SLTU	β	β	β	β
6	110	TGE	TGEU	TLT	TLTU	TEQ	SELEQZ ^{6N}	TNE	SELNEZ ^{6N}
7	111	β	*	β	β	β	*	β	β

- Specific encodings of the *rt*, *rd*, and *sa* fields are used to distinguish among the SLL, NOP, SSNOP, EHB and PAUSE functions. Release 6 makes SSNOP equivalent to NOP.
- Specific encodings of the *hint* field are used to distinguish JR from JR.HB and JALR from JALR.HB
- Release 6 removes JR and JR.HB. JALR with *rd*=0 provides functionality equivalent to JR. JALR.HB with *rd*=0 provides functionality equivalent to JR.HB. Assemblers should produce the new instruction when encountering the old mnemonic.
- Specific encodings of the *sa* field are used to distinguish pre-Release 6 and Release 6 integer multiply and divide instructions. See Table A.23 on page 440, which shows that the encodings do not conflict. The pre-Release 6 divide instructions signal Reserved Instruction exception on Release 6. Note that the same mnemonics are used for pre-Release 6 divide instructions that return both quotient and remainder, and Release 6 divide instructions that return only quotient, with separate MOD instructions for the remainder.

Table A.4 MIPS32 REGIMM Encoding of *rt* Field

rt		bits 18..16							
		0	1	2	3	4	5	6	7
bits 20..19		000	001	010	011	100	101	110	111
0	00	BLTZ	BGEZ	BLTZL ^{6R} _φ	BGEZL ^{6R} _φ	*	*	DAH ^{6N}	ε
1	01	TGEI ^{6R}	TGEIU ^{6R}	TLTI ^{6R}	TLTIU ^{6R}	TEQI ^{6R}	*	TNEI ^{6R}	*
2	10	BLTZAL ^{6R} NAL ^{6N} ¹	BGEZAL ^{6R} BAL ^{6N} ¹	BLTZALL ^{6R} _φ	BGEZALL ^{6R} _φ	*	*	*	SIGRIE ^{6N}
3	11	*	*	*	*	ε	ε	DATI ^{6N}	SYNCl [⊕]

- NAL and BAL are assembly idioms prior to Release 6.

Table A.5 MIPS32 *SPECIAL2* Encoding of Function Field

function		bits 2..0							
		0	1	2	3	4	5	6	7
bits 5..3		000	001	010	011	100	101	110	111
0	000	MADD ^{6R} 0*	MADDU ^{6R} 0*	MUL ^{6R} 0*	0*	MSUB ^{6R} 0*	MSUBU ^{6R} 0*	0*	0*
1	001	ε 0*	0*	0*	0*	0*	0*	0*	0*
2	010	0*	0*	0*	0*	0*	0*	0*	0*
3	011	0*	0*	0*	0*	0*	0*	0*	0*
4	100	CLZ ^{6Rm} 0*	CLO ^{6Rm} 0*	0*	0*	β 0*	β 0*	0*	0*
5	101	0*	0*	0*	0*	0*	0*	0*	0*
6	110	0*	0*	0*	0*	0*	0*	0*	0*
7	111	0*	0*	0*	0*	0*	0*	0*	SDBBP ^{6Rm} σ 0*

Table A.6 MIPS32 *SPECIAL3*¹ Encoding of Function Field for Release 2 of the Architecture

function		bits 2..0							
		0	1	2	3	4	5	6	7
bits 5..3		000	001	010	011	100	101	110	111
0	000	EXT \oplus	β	β	β	INS \oplus	β	β	β
1	001	ε	ε	ε	*	ε	ε	*	*
2	010	ε	ε	ε	ε	ε	ε	ε	ε
3	011	ε	LWLE ^{6R}	LWRE ^{6R}	CACHEE	SBE	SHE	SCE	SWE
4	100	BSHFL $\oplus\delta$	SWLE ^{6R}	SWRE ^{6R}	PREFE	β	CACHE ^{6Nm}	SC ^{6Nm}	β
5	101	LBUE	LHUE	*	*	LBE	LHE	LLE	LWE
6	110	ε	ε	*	*	ε	PREF ^{6Nm}	LL ^{6Nm}	β
7	111	ε	*	*	RDHWR \oplus	ε	*	*	*

1. Architecture Release 2 added the SPECIAL3 opcode. Implementations of Release 1 of the Architecture signaled a Reserved Instruction exception for this opcode and all function field values shown above.

Table A.7 MIPS32 *MOVCF*^{6R1} Encoding of *tf* Bit

tf	bit 16	
	0	1
	MOV ^{6R}	MOV ^T ^{6R}

1. Release 6 removes the MOVCI instruction family (MOV^T and MOV^F).

Table A.8 MIPS32¹ SRL Encoding of Shift/Rotate

R	<i>bit 21</i>	
	0	1
	SRL	ROTR

1. Release 2 of the Architecture added the ROTR instruction. Implementations of Release 1 of the Architecture ignored bit 21 and treated the instruction as an SRL

Table A.9 MIPS32¹ SRLV Encoding of Shift/Rotate

R	<i>bit 6</i>	
	0	1
	SRLV	ROTRV

1. Release 2 of the Architecture added the ROTRV instruction. Implementations of Release 1 of the Architecture ignored bit 6 and treated the instruction as an SRLV

Table A.10 MIPS32 BSHFL Encoding of sa Field¹

sa		<i>bits 8..6</i>							
		0	1	2	3	4	5	6	7
<i>bits 10..9</i>		000	001	010	011	100	101	110	111
0	00	BITSWAP ^{6N} 6N	*	WSBH	*	*		*	*
1	01	ALIGN ^{6N} (BSHFL)				*	*	*	*
2	10	SEB	*	*	*	*	*	*	*
3	11	SEH	*	*	*	*	*	*	*

1. The *sa* field is sparsely decoded to identify the final instructions. Entries in this table with no mnemonic are reserved for future use by MIPS technologies and may or may not cause a Reserved Instruction exception.

Table A.11 MIPS32 COP0 Encoding of rs Field

rs		bits 23..21							
		0	1	2	3	4	5	6	7
bits 25..24		000	001	010	011	100	101	110	111
0	00	MFC0	β	MFH	ε	MTC0	β	MTH	*
1	01	ε	*	RDPGPR \oplus	MFMC0 ¹ $\delta\oplus$	ε	*	WRPGPR \oplus	*
2	10	C0 δ							
3	11								

1. Release 2 of the Architecture added the MFMC0 function, which is further decoded as the DI (bit 5 = 0) and EI (bit 5 = 1) instructions.

Table A.12 MIPS32 COP0 Encoding of Function Field When rs=CO

function		bits 2..0							
		0	1	2	3	4	5	6	7
bits 5..3		000	001	010	011	100	101	110	111
0	000	*	TLBR	TLBWI	TLBINV	TLBINVF	*	TLBWR	*
1	001	TLBP	ε	ε	ε	ε	*	ε	*
2	010	ε	*	*	*	*	*	*	*
3	011	ERET	*	*	*	*	*	*	DERET σ
4	100	WAIT	*	*	*	*	*	*	*
5	101	ε	*	*	*	*	*	*	*
6	110	*	*	*	*	*	*	*	*
7	111	ε	*	*	*	*	*	*	*

Table A.13 PCREL Encoding of Minor Opcode Field

Extension		bit 20..18							
		0	1	2	3	4	5	6	7
bit 17..16		000	001	010	011	100	101	110	111
0	00	ADDIUPC	ADDIUPC	LWPC	LWPC	LWUPC	LWUPC	LDPC	*
1	01	ADDIUPC	ADDIUPC	LWPC	LWPC	LWUPC	LWUPC	LDPC	*
2	10	ADDIUPC	ADDIUPC	LWPC	LWPC	LWUPC	LWUPC	LDPC	AUIPC
3	11	ADDIUPC	ADDIUPC	LWPC	LWPC	LWUPC	LWUPC	LDPC	ALUIPC

Table A.14 MIPS32 Encoding of *rs* Field

rs		<i>bits 23..21</i>							
		0	1	2	3	4	5	6	7
<i>bits 25..24</i>		000	001	010	011	100	101	110	111
0	00	MFC1	β	CFC1	MFHC1 \oplus	MTC1	β	CTC1	MTHC1 \oplus
1	01	BC1 ^{6R} δ	BC1ANY2 ^{6R} $\delta\epsilon\triangledown$ BC1EQZ ^{6N}	BC1ANY4 ^{6R} $\delta\epsilon\triangledown$	BZ.V ϵ	*	BC1NEZ ^{6N}	*	BNZ.V ϵ
2	10	S δ	D $\delta\triangledown$	*	*	W δ	L $\delta\triangledown$	PS ^{6R} $\delta\triangledown$	*
3	11	BZ.B ϵ	BZ.H ϵ	BZ.W ϵ	BZ.D ϵ	BNZ.B ϵ	BNZ.H ϵ	BNZ.W ϵ	BNZ.D ϵ

Table A.15 MIPS32 *COP1* Encoding of Function Field When *rs=S*

function		<i>bits 2..0</i>							
		0	1	2	3	4	5	6	7
<i>bits 5..3</i>		000	001	010	011	100	101	110	111
0	000	ADD	SUB	MUL	DIV	SQRT	ABS	MOV	NEG
1	001	ROUND.L \triangledown	TRUNC.L \triangledown	CEIL.L \triangledown	FLOOR.L \triangledown	ROUND.W	TRUNC.W	CEIL.W	FLOOR.W
2	010	SEL ^{6N}	MOVCF ^{6R} δ	MOVZ ^{6R}	MOVN ^{6R}	SELEQZ ^{6N}	RECIP Δ	RSQRT Δ	SELNEZ ^{6N}
3	011	MADDF ^{6N}	MSUBF ^{6N}	RINT ^{6N}	CLASS ^{6N}	RECIP2 $\epsilon\triangledown$ ^{6R} MIN ^{6N}	RECIP1 ϵ ^{6R} MAX ^{6N}	RSQRT1 $\epsilon\triangledown$ ^{6R} MINA ^{6N}	RSQRT2 ϵ ^{6R} MAXA ^{6N}
4	100	*	CVT.D	*	*	CVT.W	CVT.L \triangledown	CVT.PS ^{6R} \triangledown	*
5	101	*	*	*	*	*	*	*	*
6	110	C.F ^{6R} CABS.F $\epsilon\triangledown$	C.UN ^{6R} CABS.UN $\epsilon\triangledown$	C.EQ ^{6R} CABS.EQ $\epsilon\triangledown$	C.UEQ ^{6R} CABS.UEQ $\epsilon\triangledown$	C.OLT ^{6R} CABS.OLT $\epsilon\triangledown$	C.ULT ^{6R} CABS.ULT $\epsilon\triangledown$	C.OLE ^{6R} CABS.OLE $\epsilon\triangledown$	C.ULE ^{6R} CABS.ULE $\epsilon\triangledown$
7	111	C.SF ^{6R} CABS.SF $\epsilon\triangledown$	C.NGLE ^{6R} CABS.NGLE $\epsilon\triangledown$	C.SEQ ^{6R} CABS.SEQ $\epsilon\triangledown$	C.NGL ^{6R} CABS.NGL $\epsilon\triangledown$	C.LT ^{6R} CABS.LT $\epsilon\triangledown$	C.NGE ^{6R} CABS.NGE $\epsilon\triangledown$	C.LE ^{6R} CABS.LE $\epsilon\triangledown$	C.NGT ^{6R} CABS.NGT $\epsilon\triangledown$

Table A.16 MIPS32 COP1 Encoding of Function Field When $rs=D$

function		bits 2..0							
		0	1	2	3	4	5	6	7
bits 5..3		000	001	010	011	100	101	110	111
0	000	ADD	SUB	MUL	DIV	SQRT	ABS	MOV	NEG
1	001	ROUND.L ∇	TRUNC.L ∇	CEIL.L ∇	FLOOR.L ∇	ROUND.W	TRUNC.W	CEIL.W	FLOOR.W
2	010	SEL ^{6N}	MOVCF ^{6R} δ	MOVZ ^{6R}	MOVN ^{6R}	SELEQZ ^{6N}	RECIP Δ	RSQRT Δ	SELNEZ ^{6N}
3	011	MADDF ^{6N}	MSUBF ^{6N}	RINT ^{6N}	CLASS ^{6N}	RECIP2 ε ^{6R} MIN ^{6N}	RECIP1 ε ^{6R} MAX ^{6N}	RSQRT1 ε ^{6R} MINA ^{6N}	RSQRT2 ε ^{6R} MAXA ^{6N}
4	100	CVT.S	*	*	*	CVT.W	CVT.L ∇	*	*
5	101	*	*	*	*	*	*	*	*
6	110	C.F ^{6R} CABS.F ε ∇	C.UN ^{6R} CABS.UN ε ∇	C.EQ ^{6R} CABS.EQ ε ∇	C.UEQ ^{6R} CABS.UEQ ε ∇	C.OLT ^{6R} CABS.OLT ε ∇	C.ULT ^{6R} CABS.ULT ε ∇	C.OLE ^{6R} CABS.OLE ε ∇	C.ULE ^{6R} CABS.ULE ε ∇
7	111	C.SF ^{6R} CABS.SF ε ∇	C.NGLE ^{6R} CABS.NGLE ε ∇	C.SEQ ^{6R} CABS.SEQ ε ∇	C.NGL ^{6R} CABS.NGL ε ∇	C.LT ^{6R} CABS.LT ε ∇	C.NGE ^{6R} CABS.NGE ε ∇	C.LE ^{6R} CABS.LE ε ∇	C.NGT ^{6R} CABS.NGT ε ∇

Table A.17 MIPS32 COP1 Encoding of Function Field When $rs=W$ or L ^{1 2}

function		bits 2..0							
		0	1	2	3	4	5	6	7
bits 5..3		000	001	010	011	100	101	110	111
0	000	CMP.AF.S/D ^{6N}	CMP.UN.S/D ^{6N}	CMP.EQ.S/D ^{6N}	CMP.UEQ.S/D ^{6N}	CMP.OLT.S/D ^{6N}	CMP.ULT.S/D ^{6N}	CMP.OLE.S/D ^{6N}	CMP.ULE.S/D ^{6N}
1	001	CMP.SAF.S/D ^{6N}	CMP.SUB.S/D ^{6N}	CMP.SEQ.S/D ^{6N}	CMP.SUEQ.S/D ^{6N}	CMP.SLT.S/D ^{6N}	CMP.SULT.S/D ^{6N}	CMP.SLE.S/D ^{6N}	CMP.SULE.S/D ^{6N}
2	010	*	CMP.OR.S/D ^{6N}	CMP.UNE.S/D ^{6N}	CMP.NE.S/D ^{6N}	*	*	*	*
3	011	*	CMP.SOR.S/D ^{6N}	CMP.SUNE.S/D ^{6N}	CMP.SNE.S/D ^{6N}	*	*	*	*
4	100	CVT.S	CVT.D	*	*	*	*	CVT.PS.PW ^{6R} ε ∇	*
5	101	*	*	*	*	*	*	*	*
6	110								
7	111								

1. Format type L is legal only if 64-bit floating point operations are enabled.
2. Release 6 introduces the CMP.condn.fmt instruction family, where .fmt=S or D, 32 or 64 bit floating point. However, .S and .D for CMP.condn.fmt are encoded as .W 10100 and .L 10101 in the “standard” format. The conditions tested are encoded the same way for pre-Release 6 C.cond.fmt and Release 6 CMP.cond.fmt, except that Release 6 adds new conditions not present in C.cond.fmt. Release 6, however, has changed the recommended mnemonics for the CMP.condn.fmt to be consistent with the IEEE standard rather than pre-Release 6. See the table in the description of CMP.cond.fmt in Volume II of the MIPS Architecture Reference Manual, which shows the correspondence between pre-Release 6 C.cond.fmt, Release 6 CMP.cond.fmt, and MSA FC*.fmt / FS*.fmt floating point comparisons.

Table A.18 MIPS32 COP1 Encoding of Function Field When $rs=PS^{1,2}$

function		bits 2..0							
		0	1	2	3	4	5	6	7
bits 5..3		000	001	010	011	100	101	110	111
0	000	ADD ^{6R} ∇	SUB ^{6R} ∇	MUL ^{6R} ∇	*	*	ABS ^{6R} ∇	MOV ^{6R} ∇	NEG ^{6R} ∇
1	001	*	*	*	*	*	*	*	*
2	010	*	MOVCF ^{6R} δ∇	MOVZ ^{6R} ∇	MOVN ^{6R} ∇	*	*	*	*
3	011	ADDR ^{6R} ε∇	*	MULR ^{6R} ε∇	*	RECIP2 ^{6R} ε∇	RECIP1 ^{6R} ε∇	RSQRT1 ^{6R} ε∇	RSQRT2 ^{6R} ε∇
4	100	CVT.S.PU ^{6R} ∇	*	*	*	CVT.PW.PS ^{6R} ε∇	*	*	*
5	101	CVT.PS ^{6R} ∇	*	*	*	PLL ^{6R} ∇	PLU ^{6R} ∇	PUL.PS ^{6R} ∇	PUU.PS ^{6R} ∇
6	110	C.F.PS ^{6R} ∇ CABS.F.PS ε∇	C.UN.PS ^{6R} ∇ CABS.UN ε∇	C.EQ ^{6R} ∇ CABS.EQ ε∇	C.UEQ.PS ^{6R} ∇ CABS.UEQ.PS ε∇	C.OLT.PS ^{6R} ∇ CABS.OLT.PS ε∇	C.ULT ^{6R} ∇ CABS.ULT ε∇	C.OLE ^{6R} ∇ CABS.OLE ε∇	C.ULE.PS ^{6R} ∇ CABS.ULE.PS ε∇
7	111	C.SF.PS ^{6R} ∇ CABS.SF.PS ε∇	C.NGLE.PS ^{6R} ∇ CABS.NGLE.PS ε∇	C.SEQ.PS ^{6R} ∇ CABS.SEQ.PS ε∇	C.NGL.PS ^{6R} ∇ CABS.NGL.PS ε∇	C.LT.PS ^{6R} ∇ CABS.LT.PS ε∇	C.NGE.PS ^{6R} ∇ CABS.NGE.PS ε∇	C.LE.PS ^{6R} ∇ CABS.LE.PS ε∇	C.NGT.PS ^{6R} ∇ CABS.NGT.PS ε∇

1. Format type *PS* is legal only if 64-bit floating point operations are enabled. All encodings in this table are reserved in Release 6.
2. Release 6 removes format type *PS* (paired single). *MSA* (MIPS SIMD Architecture) may be used instead.

Table A.19 MIPS32 COP1 Encoding of *tf* Bit When $rs=S, D,$ or PS^{6R} , Function= $MOVCF^{6R}$ ¹

tf	bit 16	
	0	1
	MOVf.fmt ^{6R}	MOVt.fmt ^{6R}

1. Release 6 removes the *MOVCF* instruction family (*MOVf.fmt* and *MOVt.fmt*), replacing them by *SEL.fmt*.

Table A.20 MIPS32 COP2 Encoding of *rs* Field

rs		bits 23..21							
		0	1	2	3	4	5	6	7
bits 25..24		000	001	010	011	100	101	110	111
0	00	MFC2 θ	β	CFC2 θ	MFHC2 θ⊕	MTC2 θ	β	CTC2 θ	MTHC2 θ⊕
1	01	BC2 ^{6R} θ	BC2EQZ ^{6N}	LWC2 ^{6Nm} θ	SWC2 ^{6Nm} θ	θ	BC2NEZ ^{6N} θ	LDC2 ^{6Nm} θ	SDC2 ^{6Nm} θ
2	10	C2 θ δ							
3	11								

Table A.21 MIPS32 COP1X^{6R1} Encoding of Function Field

function		bits 2..0							
bits 5..3		0	1	2	3	4	5	6	7
		000	001	010	011	100	101	110	111
0	000	LWXC1 ^{6R} Δ	LDXC1 ^{6R} Δ	*	*	*	LUXC1 ^{6R} ∇	*	*
1	001	SWXC1 ^{6R} Δ	SDXC1 ^{6R} Δ	*	*	*	SUXC1 ^{6R} ∇	*	PREFIX ^{6R} Δ
2	010	*	*	*	*	*	*	*	*
3	011	*	*	*	*	*	*	ALNV.PS ^{6R} ∇	*
4	100	MADD.S ^{6R} Δ ²	MADD.D ^{6R} Δ ²	*	*	*	*	MADD.PS ^{6R} ∇	*
5	101	MSUB.S ^{6R} Δ ²	MSUB.D ^{6R} Δ ²	*	*	*	*	MSUB.PS ^{6R} ∇	*
6	110	NMADD.S ^{6R} Δ ²	NMADD.D ^{6R} Δ ²	*	*	*	*	NMADD.PS ^{6R} ∇	*
7	111	NMSUB.S ^{6R} Δ ²	NMSUB.D ^{6R} Δ ²	*	*	*	*	NMSUB.PS ^{6R} ∇	*

1. Release 6 removes format type PS (paired single). MSA (MIPS SIMD Architecture) may be used instead.
2. Release 6 removes all pre-Release 6 COP1X instructions, of the form 010011 - COP1X.PS, non-fused FP multiply adds, and indexed and unaligned loads, stores, and prefetches.

A.3 Floating Point Unit Instruction Format Encodings

Instruction format encodings for the floating point unit are presented in this section. This information is a tabular presentation of the encodings described in tables ranging from Table A.14 to Table A.21 above.

Table A.22 Floating Point Unit Instruction Format Encodings

<i>fmt</i> field (bits 25..21 of COP1 opcode)		<i>fmt3</i> field (bits 2..0 of COP1X opcode)		Mnemonic	Name	Bit Width	Data Type
Decimal	Hex	Decimal	Hex				
0..15	00..0F	—	—	Used to encode Coprocessor 1 interface instructions (MFC1, CTC1, etc.). Not used for format encoding.			
16	10	0	0	S	Single	32	Floating Point
				See note below: Release 6 CMP.condn.S/D encoded as W/L.			
17	11	1	1	D	Double	64	Floating Point
				See note below: Release 6 CMP.condn.S/D encoded as W/L.			
18..19	12..13	2..3	2..3	Reserved for future use by the architecture.			
20	14	4	4	W	Word	32	Fixed Point
				See note below: Release 6 CMP.condn.S/D encoded as W/L.			
21	15	5	5	L	Long	64	Fixed Point
				See note below: Release 6 CMP.condn.S/D encoded as W/L.			
22	16	6	6	PS	Paired Single	2 × 32	Floating Point
				Release 6 removes the PS format, and reserves it for future use			
23	17	7	7	Reserved for future use by the architecture.			

Table A.22 Floating Point Unit Instruction Format Encodings

<i>fmt</i> field (bits 25..21 of COP1 opcode)		<i>fmt3</i> field (bits 2..0 of COP1X opcode)		Mnemonic	Name	Bit Width	Data Type
Decimal	Hex	Decimal	Hex				
24..31	18..1F	—	—	Reserved for future use by the architecture. Not available for <i>fmt3</i> encoding.			

Note: Release 6 CMP.condn.S/D encoded as W/L: as described in Table A.17 on page 435, “MIPS32 COP1 Encoding of Function Field When rs=W or L” on page 435, Release 6 uses certain instruction encodings with the *rs* (*fmt*) field equal to 11000 (W) or 11001 (L) to represent S and D respectively, for the instruction family CMP.condn.fmt.

A.4 Release 6 Instruction Encodings

Release 6 adds several new instructions, removes several old instructions, and changes the encodings of several pre-Release 6 instructions. In many cases, the old encodings for instructions moved or removed are required to signal the Reserved Instruction on Release 6, so that uses of old instructions can be trapped, and emulated or warned about; but in several cases the old encodings have been reused for new Release 6 instructions.

These instruction encoding changes are indicated in the tables above. Release 6 new instructions are superscripted 6N; Release 6 removed instructions are superscripted 6R; Release 6 instructions that have been moved are marked 6Rm at the pre-Release 6 encoding that they are moved from, and 6Nm at the new Release 6 encoding that it is moved to. Encoding table cells that contain both a non-Release 6 instruction and a Release 6 instruction superscripted 6N or 6Nm indicate a possible conflict, although in many cases footnotes indicate that other fields allow the distinction to be made.

The tables below show the further decoding in Release 6 for field classes (instruction encoding families) indicated in other tables.

Instruction encodings are also illustrated in the instruction descriptions in Volume II. Those encodings are authoritative. The instruction encoding tables in this section, above, based on bitfields, are illustrative, since they cannot completely indicate the new tighter encodings.

MUL/DIV family encodings: Table A.23 below shows the Release 6 integer family of multiply and divide instructions encodings, as well as the pre-Release 6 instructions they replace. The Release 6 and pre-Release 6 instructions share the same primary opcode, bits 31-26 = 000000, and share the function code, bits 5-0, with their pre-Release 6 counterparts, but are distinguished by bits 10-6 of the instruction. The pre-Release 6 instructions signal a Reserved Instruction exception on Release 6 implementations.

However, the instruction names collide: pre-Release 6 and Release 6 DIV, DIVU, DDIV, DDIVU are actually distinct instructions, although they share the same mnemonics. The pre-Release 6 instructions produce two results, both quotient and remainder in the HI/LO register pair, while the Release 6 DIV instruction produce only a single result, the quotient. It is possible to distinguish the conflicting instructions in assembly by looking at how many register operands the instructions have, two versus three.

As of Release 6, all of pre-Release 6 instruction encodings that are removed are required to signal the reserved instruction exception, as are all in the vicinity 000000.xxxxx.xxxxx.aaaaa.011xxx, i.e. all with the primary opcodes and function codes listed in Table A.23, with the exception of the aaaaa field values 00010 and 00011 for the new instructions.

Table A.23 Release 6 MUL/DIV encodings

pre-Release 6 removed ~~struck through~~
 00000.rs.rt.rd.aaaaa.function6

function bits 5-0	aaaaa, bits 10-6		
	00000 and rd = 00000 (bits 15-11)	00010	00011
011 000	MULT ^{6R}	MUL ^{6N}	MUH ^{6N}
011 001	MULTU ^{6R}	MULU ^{6N}	MUHU ^{6N}
011 010	DIV ^{6R}	DIV ^{6N}	MOD ^{6N}
011 011	DIVU ^{6R}	DIVU ^{6N}	MODU ^{6N}
011 100	β^{6R}	β^{6N}	β^{6N}
011 101	β^{6R}	β^{6N}	β^{6N}
011 110	β^{6R}	β^{6N}	β^{6N}
011 111	β^{6R}	β^{6N}	β^{6N}

PC-relative family encodings: Table A.24 and Table A.25 present the PC-relative family of instruction encodings. Table A.24 in traditional form, Table A.25 in the bitstring form that clearly shows the immediate varying from 19 bits to 16 bits.

Table A.24 Release 6 PC-relative family encoding

111011.rs.TTTT.immediate

rs		bits 18-16							
		0	1	2	3	4	5	6	7
bits 20-19		000	001	010	011	100	101	110	111
0	00	ADDIUP ^{6N} immediate							
1	01	LWP ^{6N} immediate							
2	10	β^{6N}							
3	11	β^{6N}				reserved (RI)		AUIP ^{6N} immediate	ALUIP ^{6N} immediate

Table A.25 Release 6 PC-relative family encoding bitstrings

111011.rs.*

encoding	instruction
111011.rs.00.<-----immediate>	ADDIUPC ^{6N}
111011.rs.01.<----off19>	LWPC ^{6N}
111011.rs.10.<----off19>	β^{6N}
111011.rs.110.<---off18>	β^{6N}
111011.rs.1110.<---imm17>	reserved, signal RI ^{6N}
111011.rs.11110.<--immediate>	AUIPC ^{6N}
111011.rs.11111.<--immediate>	ALUIPC ^{6N}

B*C compact branch and jump encodings: In several cases Release 6 uses much tighter instruction encodings than previous releases of the MIPS architecture, reducing redundancy, to allow more instructions to be encoded. Instead of purely looking at bitfields, Release 6 defines encodings that compare different bitfields: e.g. the encoding 010110.rs.rt.offset16 is BGEZC if neither rs nor rt are 00000 and rs is not equal to rt, but is BGEZ if rs is the same as rt, and is BLEZC if rs is 00000 and rt is not. (The encoding with rt 00000 and arbitrary rs is the pre-Release 6 instruction BLEZL.rs.00000.offset16, a branch likely instruction which is removed by Release 6, and whose encoding is required to signal the Reserved Instruction exception.)

This tight instruction encoding motivates the bitstring and constraints notation for Release 6 instruction encodings

BLEZC rt	010110.00000.rt.offset16,	rt!=0
BGEZC rt	010110.rs=rt.rt.offset16, rs!=0,	rt!=0, rs=rt
BGEC rs,rt	10110.rs.rt.offset16, rs!=0,	rt!=0, rs!=rt
BLEZL rt	010110.00000.rt.offset16,	rs=0

and the equivalent constraints indicated in the instruction encoding diagrams for the instruction descriptions in Volume II. Table A.26 below shows the B*C compact branch encodings, which use constraints such as RS = RT. pre-Release 6 encodings that are removed by Release 6 are shaded darkly, while the remaining redundant encodings are shaded lightly or stippled.

Note: Pre-Release 6 instructions BLEZL, BGTZL, BLEZ, and BGTZ do not conflict with the new Release 6 instructions they are tightly packed with in the encoding tables, but the ADDI, DADDI, LWC2, SWC2, LDC2 and SDC2 truly conflict.

Table A.26 B*C compact branch encodings

Primary Opcode	Constraints involving rs and rt fields			
	rs/rt ₀ /NZ		NZ _{rs} =/</> NZ _{rt}	
010 110	0 _{rs} 0 _{rt}	useless BLEZL ^{6R}	BGEZC ^{6N}	=
	0 _{rs} NZ _{rt}	BLEZC ^{6N}	BGECC ^{6N} (BLEC)	<
	NZ _{rs} 0 _{rt}	BLEZL ^{6R}		>
<i>rs</i> _{NZ} ≠ <i>rt</i> _{NZ}				
010 111	0 _{rs} 0 _{rt}	useless BGTZL ^{6R}	BLTZC ^{6N}	=
	0 _{rs} NZ _{rt}	BGTZC ^{6N}	BLTCC ^{6N} (BGTC)	<
	NZ _{rs} 0 _{rt}	BGTZL ^{6R}		>
<i>rs</i> _{NZ} ≠ <i>rt</i> _{NZ}				
001 000	ADDI			
	0 _{rs} NZ _{rt}	BEQZALC ^{6N}	BEQC ^{6N}	<
	0 _{rs} 0 _{rt}	BOVC ^{6N}		=
NZ _{rs} 0 _{rt}	>			
<i>rs</i> _{NZ} ≥ <i>rt</i> ₀ , <i>NZ</i>				
110 110	LDC2^{6R}			
	0 _{rs} 0/NZ _{rt}	0 _{rs} NZ _{rt}	JIC ^{6N} rt+off16	<
		0 _{rs} 0 _{rt}		=
NZ _{rs} 0 _{rt}	BEQZC ^{6N} <i>rs</i> _{NZ} , off21		>	
<i>NZ</i> _{rs} 0/ <i>NZ</i> _{rt}				
110 010	LWC2^{6R}			
	BC ^{6N} off26<<2		0/ <i>NZ</i> _{rs} 0/ <i>NZ</i> _{rt}	

Primary Opcode	Constraints involving rs and rt fields			
	rs/rt ₀ /NZ		NZ _{rs} =/</> NZ _{rt}	
000 110	0 _{rs} 0 _{rt}	useless BLEZ	BGEZALC ^{6N}	=
	0 _{rs} NZ _{rt}	BLEZALC ^{6N}	BGEUC ^{6N} (BLEUC)	<
	NZ _{rs} 0 _{rt}	BLEZ		>
<i>rs</i> _{NZ} ≠ <i>rt</i> _{NZ}				
000 111	0 _{rs} 0 _{rt}	useless BGTZ	BLTZALC ^{6N}	=
	0 _{rs} NZ _{rt}	BGTZALC ^{6N}	BLTUC ^{6N} (BGTUC)	<
	NZ _{rs} 0 _{rt}	BGTZ		>
<i>rs</i> _{NZ} ≠ <i>rt</i> _{NZ}				
011 000	DADDI^{6R}			
	0 _{rs} NZ _{rt}	BNEZALC ^{6N}	BNEC ^{6N}	<
	0 _{rs} 0 _{rt}	BNVC ^{6N}		=
NZ _{rs} 0 _{rt}	>			
<i>rs</i> _{NZ} ≥ <i>rt</i> ₀ , <i>NZ</i>				
110 110	SDC2^{6R}			
	0 _{rs} 0/NZ _{rt}	0 _{rs} NZ _{rt}	JIALC ^{6N} rt+off16	<
		0 _{rs} 0 _{rt}		=
NZ _{rs} 0 _{rt}	BNEZC ^{6N} <i>rs</i> _{NZ} , off21		>	
<i>NZ</i> _{rs} 0/ <i>NZ</i> _{rt}				
111 010	SWC2^{6R}			
	BALC ^{6N} off26<<2		0/ <i>NZ</i> _{rs} 0/ <i>NZ</i> _{rt}	

Revision History

Revision	Date	Description
0.90	November 1, 2000	Internal review copy of reorganized and updated architecture documentation.
0.91	November 15, 2000	Internal review copy of reorganized and updated architecture documentation.
0.92	December 15, 2000	Changes in this revision: <ul style="list-style-type: none"> • Correct sign in description of MSUBU. • Update JR and JALR instructions to reflect the changes required by MIPS16.
0.95	March 12, 2001	Update for second external review release
1.00	August 29, 2002	Update based on all review feedback: <ul style="list-style-type: none"> • Add missing optional select field syntax in mtc0/mfc0 instruction descriptions. • Correct the PREF instruction description to acknowledge that the PrepareForStore function does, in fact, modify architectural state. • To provide additional flexibility for Coprocessor 2 implementations, extend the <i>sel</i> field for DMFC0, DMTC0, MFC0, and MTC0 to be 8 bits. • Update the PREF instruction to note that it may not update the state of a locked cache line. • Remove obviously incorrect documentation in DIV and DIVU with regard to putting smaller numbers in register <i>rt</i>. • Fix the description for MFC2 to reflect data movement from the coprocessor 2 register to the GPR, rather than the other way around. • Correct the pseudo code for LDC1, LDC2, SDC1, and SDC2 for a MIPS32 implementation to show the required word swapping. • Indicate that the operation of the CACHE instruction is UNPREDICTABLE if the cache line containing the instruction is the target of an invalidate or writeback invalidate. • Indicate that an Index Load Tag or Index Store Tag operation of the CACHE instruction must not cause a cache error exception. • Make the entire right half of the MFC2, MTC2, CFC2, CTC2, DMFC2, and DMTC2 instructions implementation dependent, thereby acknowledging that these fields can be used in any way by a Coprocessor 2 implementation. • Clean up the definitions of LL, SC, LLD, and SCD. • Add a warning that software should not use non-zero values of the stype field of the SYNC instruction. • Update the compatibility and subsetting rules to capture the current requirements.

Revision	Date	Description
1.90	September 1, 2002	<p>Merge the MIPS Architecture Release 2 changes in for the first release of a Release 2 processor. Changes in this revision include:</p> <ul style="list-style-type: none"> • All new Release 2 instructions have been included: DI, EHB, EI, EXT, INS, JALR.HB, JR.HB, MFHC1, MFHC2, MTHC1, MTHC2, RDHWR, RDPGPR, ROTR, ROTRV, SEB, SEH, SYNCI, WRPGPR, WSBH. • The following instruction definitions changed to reflect Release 2 of the Architecture: DERET, ERET, JAL, JALR, JR, SRL, SRLV • With support for 64-bit FPUs on 32-bit CPUs in Release 2, all floating point instructions that were previously implemented by MIPS64 processors have been modified to reflect support on either MIPS32 or MIPS64 processors in Release 2. • All pseudo-code functions have been updated, and the Are64BitFPOperationsEnabled function was added. • Update the instruction encoding tables for Release 2.
2.00	June 9, 2003	<p>Continue with updates to merge Release 2 changes into the document. Changes in this revision include:</p> <ul style="list-style-type: none"> • Correct the target GPR (from rd to rt) in the SLTI and SLTIU instructions. This appears to be a day-one bug. • Correct CPR number, and missing data movement in the pseudocode for the MTC0 instruction. • Add note to indicate that the CACHE instruction does not take Address Error Exceptions due to mis-aligned effective addresses. • Update SRL, ROTR, SRLV, ROTRV, DSRL, DROTR, DSRLV, DROTRV, DSRL32, and DROTR32 instructions to reflect a 1-bit, rather than a 4-bit decode of shift vs. rotate function. • Add programming note to the PrepareForStore PREF hint to indicate that it cannot be used alone to create a bzero-like operation. • Add note to the PREF and PREFX instruction indicating that they may cause Bus Error and Cache Error exceptions, although this is typically limited to systems with high-reliability requirements. • Update the SYNCI instruction to indicate that it should not modify the state of a locked cache line. • Establish specific rules for when multiple TLB matches can be reported (on writes only). This makes software handling easier.
2.50	July 1, 2005	<p>Changes in this revision:</p> <ul style="list-style-type: none"> • Correct figure label in LWR instruction (it was incorrectly specified as LWL). • Update all files to FrameMaker 7.1. • Include support for implementation-dependent hardware registers via RDHWR. • Indicate that it is implementation-dependent whether prefetch instructions cause EJTAG data breakpoint exceptions on an address match, and suggest that the preferred implementation is not to cause an exception. • Correct the MIPS32 pseudocode for the LDC1, LDXC1, LUXC1, SDC1, SDXC1, and SUXC1 instructions to reflect the Release 2 ability to have a 64-bit FPU on a 32-bit CPU. The correction simplifies the code by using the ValueFPR and StoreFPR functions, which correctly implement the Release 2 access to the FPRs. • Add an explicit recommendation that all cache operations that require an index be done by converting the index to a kseg0 address before performing the cache operation. • Expand on restrictions on the PREF instruction in cases where the effective address has an uncached coherency attribute. •

Revision History

Revision	Date	Description
2.60	June 25, 2008	<p>Changes in this revision:</p> <ul style="list-style-type: none"> • Applied the new B0.01 template. • Update RDHWR description with the UserLocal register. • added PAUSE instruction • Ordering SYNCs • CMP behavior of CACHE, PREF*, SYNCI • CVT.S.PL, CVT.S.PU are non-arithmetic (no exceptions) • *MADD.fmt & *MSUB.fmt are non-fused. • various typos fixed
2.61	July 10, 2008	<ul style="list-style-type: none"> • Revision History file was incorrectly copied from Volume III. • Removed index conditional text from PAUSE instruction description. • SYNC instruction - added additional format “SYNC stype”
2.62	January 2, 2009	<ul style="list-style-type: none"> • LWC1, LWXC1 - added statement that upper word in 64bit registers are UNDEFINED. • CVT.S.PL and CVT.S.PU descriptions were still incorrectly listing IEEE exceptions. • Typo in CFC1 Description. • CCRes is accessed through \$3 for RDHWR, not \$4.
3.00	March 25, 2010	<ul style="list-style-type: none"> • JALX instruction description added. • Sub-setting rules updated for JALX. •
3.01	June 01, 2010	<ul style="list-style-type: none"> • Copyright page updated. • User mode instructions not allowed to produce UNDEFINED results, only UNPREDICTABLE results.
3.02	March 21, 2011	<ul style="list-style-type: none"> • RECIP, RSQRT instructions do not require 64-bit FPU. • MADD/MSUB/NMADD/NMSUB pseudo-code was incorrect for PS format check.
3.50	September 20, 2012	<ul style="list-style-type: none"> • Added EVA load/store instructions: LBE, LBUE, LHE, LHUE, LWE, SBE, SHE, SWE, CACHEE, PREFE, LLE, SCE, LWLE, LWRE, SWLE, SWRE. • TLBWI - can be used to invalidate the VPN2 field of a TLB entry. • FCSR.MAC2008 bit affects intermediate rounding in MADD.fmt, MSUB.fmt, NMADD.fmt and NMSUB.fmt. • FCSR.ABS2008 bit defines whether ABS.fmt and NEG.fmt are arithmetic or not (how they deal with QNAN inputs).
3.51	October 20, 2012	<ul style="list-style-type: none"> • CACHE and SYNCI ignore RI and XI exceptions. • CVT, CEIL, FLOOR, ROUND, TRUNC to integer can't generate FP-Overflow exception.
5.00	December 14, 2012	<ul style="list-style-type: none"> • R5 changes: DSP and MT ASEs -> Modules • NMADD.fmt, NMSUB.fmt - for IEEE2008 negate portion is arithmetic.
5.01	December 15, 2012	<ul style="list-style-type: none"> • No technical content changes: • Update logos on Cover. • Update copyright page.
5.02	April 22, 2013	<ul style="list-style-type: none"> • Fix: Figure 2.26 Are64BitFPOperationsEnabled Pseudocode Function - “Enabled” was missing. • R5 change retroactive to R3: removed FCSR.MCA2008 bit: no architectural support for fused multiply add with no intermediate rounding. Applies to MADD.fmt, MSUB.fmt, NMADD.fmt, NMSUB.fmt. • Clarification: references to “16 FP registers mode” changed to “the FR=0 32-bit register model”; specifically, paired single (PS) instructions and long (L) format instructions have UNPREDICTABLE results if FR=0, as well as LUXC1 and SUXC1. • Clarification: C.cond.fmt instruction page: cond bits 2..1 specify the comparison, cond bit 0 specifies ordered versus unordered, while cond bit 3 specifies signaling versus non-signaling. • R5 change: UFR (User mode FR change): CFC1, CTC1 changes.

Revision	Date	Description
5.03	August 21, 2013	<ul style="list-style-type: none"> Resolved inconsistencies with regards to the availability of instructions in MIPS32r2: MADD.fmt family (MADD.S, MADD.D, NMADD.S, NMADD.D, MSUB.S, MSUB.D, NMSUB.S, NMSUB.D), RECIP.fmt family (RECIP.S, RECIP.D, RSQRT.S, RSQRT.D), and indexed FP loads and stores (LWXC1, LDXC1, SWXC1, SDXC1). The appendix section A.2 “Instruction Bit Encoding Tables”, shared between Volume I and Volume II of the ARM, was updated, in particular the new upright delta Δ mark is added to Table A.2 “Symbols Used in the Instruction Encoding Tables”, replacing the inverse delta marking ∇ for these instructions. Similar updates made to microMIPS’s corresponding sections. Instruction set descriptions and pseudocode in Volume II, Basic Instruction Set Architecture, updated. These instructions are required in MIPS32r2 if an FPU is implemented. . Misaligned memory access support for MSA: see Volume II, Appendix B “Misaligned Memory Accesses”. Has2008 is required as of release 5 - Table 5.4, “FIR Register Descriptions”. ABS2008 and NAN2008 fields of Table 5.7 “FCSR RegisterField Descriptions” were optional in release 3 and could be R/W, but as of release 5 are required, read-only, and preset by hardware. FPU FCSR.FS Flush Subnormals / Flush to Zero behavior is made consistent with MSA behavior, in MSACSR.FS: Table 5.7, “FCSR Register Field Descriptions”, updated. New section 5.8.1.4 “Alternate Flush to Zero Underflow Handling”. Volume I, Section 2.2 “Compliance ad Subsetting” noted that the L format is required in MIPS FPUs, to be consistent with Table 5.4 “FIR Register Field Definitions” . Noted that UFR and UNFR can only be written with the value 0 from GPR[0]. See section 5.6.5 “User accessible FPU Register model control (UFR, CP1 Control Register 1)” and section 5.6.5 “User accessible Negated FPU Register model control (UNFR, CP1 Control Register 4)”
5.04	December 11, 2013	<p>LLSC Related Changes</p> <ul style="list-style-type: none"> Added ERETNC. New. Modified SC handling: refined, added, and elaborated cases where SC can fail or was UNPREDICTABLE. <p>XPA Related Changes</p> <ul style="list-style-type: none"> Added MTHC0, MFHC0 to access extensions. All new. Modified MTC0 for MIPS32 to zero out the extended bits which are writable. This is to support compatibility of XPA hardware with non XPA software. In pseudo-code, added registers that are impacted. MTHC0 and MFHC0 - Added RI conditions.
6.00 - R6U draft	Dec. 19, 2013	<ul style="list-style-type: none"> Feature complete R6U draft of Volume II new instructions.
	Jan 14-16, 2014	<ul style="list-style-type: none"> Split MAX.fmt-family, instruction description that described multiple instructions, into separate instruction description pages MAX.fmt, MAX_A.fmt, MIN.fmt, MIN_A.fmt. Mnemonic change: AUIPA changed to ALUIPC, Aligned Add Upper Immediate to PC. Now all Release 6 new PC relative instructions end in “P”. Renamed CMP.cond.fmt -> CMP.condn.fmt, i.e. renamed 5-bit cond field “condn” to distinguish it from old 4-bit cond field. Cleaning up descriptions of NAL and BAL to reduce confusion about deprecation versus removal of BLTZAL and BGEZAL. DAHI and DATI use rs src/dest register, not rt. Table showing that the compact branches are complete, reversing rs and rt for BLEC, BGTC, BLEUC, BGTUC Forbidden slot RI required; takes exception like delay slot; boilerplate consistency automated. MOD instruction family: remainder has same sign as dividend Updated to R6U 1.03

Revision History

Revision	Date	Description
	Jan 17, 2014	<ul style="list-style-type: none"> NAL, BAL: improved confusing explanation of how NAL and BAL used to be special cases of BLEZAL, etc., instructions removed by Release 6 Forbidden slot boilerplate: requires Reserved Instruction exception for control instructions, even if interrupted: exception state (EPC, etc.) points to branch, not forbidden slot, like delay slot.
	Jan 20, 2014	<ul style="list-style-type: none"> Fixed bugs and changed instruction encodings: BEQZALC, BNEZALC, BGEUC, BLTUC, BLEZLC family, BC1EQZ, BC2EQZ, BC1NEZ, BC2NEZ, BITSWAP AUI, BAL
R6U draft	Feb 10, 2014	<ul style="list-style-type: none"> Refactored “Compatibility and Subsetting” sections of Volumes I and II for reuse without replication. Updated Volume II tables of instructions by categories (preceding section entitled Alphabetical List of Instructions) for R6U changes.
R6U-pre-release draft	Feb. 11, 2014	<p>Technical Publications preparing for release.</p> <p><u>Summary of all R6U drafts up to this date - R6U version 1.03</u></p> <ul style="list-style-type: none"> MIPS3D removed from the Release 6 architecture. Some 3-source instructions (conditional moves) replaced with new 2-source instructions: MOVZ/MOVN.fmt replaced by SELEQZ/SELNEZ.fmt; MOVZ/MOVN replaced by SELEQZ/SELNEZ. PREF/PREFE: Unsound prefetch hints downgraded; optional implementation dependent prefetch hints expanded. <p><u>Free up Opcode Space</u></p> <ul style="list-style-type: none"> Change encodings of LL/SC/LLD/SCD/PREF/CACHE, reducing offset from 16 bits to 9 bits SPECIAL2 encodings changed: CLO/CLZ/DCLO/DCLZ Other changes mentioned below: traps with immediate operands removed (ADDI/DADDI, TGEI/TGEIU/TLTI/TLTIU/TEQI/TNEI) Free 15 major opcodes: COPIX, SPECIAL2, LWL/LWR, SWL/SWR, LDL/LDR, SDL/SDR, LL/SC, LLD/SCD, PREF, CACHE, as described below, by changing encodings. <hr/> <p><u>Integer Multiply and Divide</u></p> <ul style="list-style-type: none"> Integer accumulators (HI/LO) removed from base Release 6, moved to DSPr6, allowed only with microMIPS: MFHI, MTHIO, MFLO, MTLO, MADD, MADDU, MUL, MSUB, MSUBU removed. Release 6 adds multiply and divide instructions that write to same-width register: MULT replaced by MUL/MUH; MULTU replaced by MULU/MUHU; DIV replaced by DIV/MOD; DIVU replaced by DIVU/MODU; similarly for 64-bit DMUH, etc.

Revision	Date	Description
		<p><u>Control Transfer Instructions (CTIs)</u></p> <ul style="list-style-type: none"> • Branch likely instructions removed by Release 6: BEQL, etc. • Enhanced compact branches and jumps provided • No delay slots; back-to-back branches disallowed (forbidden slot) • More complete set of conditions: BEQC/BNEC, all signed and unsigned reg-reg comparisons, e.g. BLTC, BLTUC; all comparisons against zero, e.g. BLTZC • More complete set of conditional procedure call instructions: BEQZALC, BNEZALC • Large offset PC-relative branches: BC/BALC 26-bit offset (scaled by 4); BEQZC/BNEZC 21-bit offset • JIC/JIALC: “indexed” jumps, jump to register + sign extended 16-bit offset • Trap-in-overflow adds with immediate removed by MIOPSr6: ADDI, DADDI; replaced by branches on overflow BOVC/BNVC. • Redundant JR.HB removed, aliased to JALR.HB with rdest=0. • BLTZAL/BGEZAL removed; not used because unconditionally wrote link register SSNOP identical to NOP. <p><u>Misaligned Memory Accesses</u></p> <ul style="list-style-type: none"> • Unaligned load/store instructions (LWL/LWR, etc.) removed from Release 6. Support for misaligned memory accesses must be provided by a Release 6 system for all ordinary loads and stores, by hardware or by software trap-and-emulate. • CPU scalar ALIGN instruction <p><u>Address Generation and Constant Building</u></p> <ul style="list-style-type: none"> • Instructions to build large constants (such as address constants): AUI (Add upper immediate), DAHI, DATI. • Instructions for PC-relative address formation: ADDIUPC, ALUIPC. • PC-relative loads: LWP, LWUP, LDP. • Indexed FPU memory accesses removed: LWXC1, LUXC1, PFX, etc. • Load-scaled-address instructions: LSA, DLSA • 32-bit address wrapping improved. <p><u>DSP ASE</u></p> <ul style="list-style-type: none"> • DSP ASE and SmartMIPS disallowed; recommend MSA instead • DSPr6 to be defined, used with microMIPS. • Instructions promoted from DSP ASE to Base ISA: BALIGN becomes Release 6 ALIGN, BITREV becomes Release 6 BITSWAP

Revision	Date	Description
		<p><u>FPU and co-processor</u></p> <ul style="list-style-type: none"> • Instruction encodings changed: COP2 loads/stores, cache/prefetch, SPECIAL2: LWC2/SWC2, LDC2/SWC2 • FR=0 not allowed, FR=1 required. • Compatibility and Subsetting section amended to allow a single precision only FPU (FIR.S=FIR.W=1, FIR.D=FIR.L=0.) • Paired Single (PS) removed from the Release 6 architecture, including: COP1.PS, COP1X.PS, BC1ANY2, BC1ANY4, CVT.PS.S, CVT.PS.W. • FPU scalar counterparts to MSA instructions: RINT.fmt, CLASS.fmt, MAX/MAXA/MIN/MINA.fmt. • Unfused multiply adds removed: MADD/MSUB/NMADD/NMSUB.fmt • IEEE2008 Fused multiply adds added: MADDF/MSUBF.fmt • Floating point condition codes and related instructions removed: C.cond.fmt removed, BC1T/BC1F, MOVF/MOVT. • MOVF/MOVT.fmt replaced by SEL.fmt • New FP compare instruction CMP.cond.fmt places result in FPR and related BC1EQZ/BC2EQZ • New FP comparisons: CMP.cond.fmt with cond = OR (ordered), UNE (Unordered or Not Equal), NE (Not Equal). • Coprocessor 2 condition codes removed: BC2F/BC2T removed, replaced by BC2NEQZ/BC2EQZ <p><u>Recent R6U architecture changes not fully reflected in this draft:</u></p> <ul style="list-style-type: none"> • This draft does not completely reflect the new 32-bit address wrapping proposal but still refers in some places to the old IAM (Implicit Address Mode) proposal. • This draft does not yet reflect constraints on endianness, in particular in the section Misaligned memory access support: e.g. code and data must have the same endianness, Status.RE is removed, etc. • BC1EQZ/BC1NEZ will test only bit 0 of the condition register, not all bits. • This draft does not yet say that writing to a 32-bit FPR renders upper bits of a 64 bit FPR or 128 bit floating point register UNPREDICTABLE; it describes the old proposal of zeroing the upper bits. <p><u>Known issues:</u></p> <ul style="list-style-type: none"> • This draft describes Release 6, as well as earlier releases of the MIPS architecture. E.g. instructions that were present in MIPSr5 but which were removed in Release 6 are still in the manual, although they should be clearly marked “removed by Release 6” to indicate that they have been removed by Release 6. • R6U new instruction pseudocode is 64-bit, rather than 32-bit, albeit attempting to use notations that apply to both. • Certain new instruction descriptions are “unsplit”, describing families of instructions such as all compact branches, rather than separate descriptions of each instruction. This facilitates comparison and consistency, but currently allows certain MIPS64 Release 6 instructions to appear inappropriately in the MIPS32 Release 6 manual. A future release of the manual will “split” these instruction family descriptions, e.g. the compact branch family will be split up into at least 12 different instruction descriptions. • R6U requires misalignment support for all ordinary memory reference instructions, but the pseudocode does not yet reflect this. Boilerplate has been added to all existing instructions saying this. • The new R6U PC-relative loads (LWP, LWUP, LDP) in this draft incorrectly say that misaligned accesses are permitted.

Revision	Date	Description
R6U-pre-release draft	Feb. 13, 2014	<ul style="list-style-type: none"> ALIGN/DALIGN: clarified bp=0 behavior ALIGN/DALIGN pseudocode used as logical OR rather than MIPS' pseudocode concatenate. Removed incorrect note about not using r31 as a source register to BAL. Release 6 requires BC1EQZ/BC1NEZ if an FPU is present, i.e. they cannot signal RI. R6U 1.05 change: BC1EQZ/BC1NEZ test only bit 0 of the FPY; changed from testing if any bit nonzero; helps with trap-and-emulate of DP on an SP-only FPU. Known problem: R6U 1.05 change not yet made: all 32-bit FP operations leave upper bits of 64 bit FOR and/or 128-bit MSR unpredictable; helps with trap-and-emulate of DP on an SP-only FPU. Clearly marked all .PS instructions as removed via removed by Release 6 in instruction format. DMUL, DMULTU, DDIV, DDIVU marked removed by Release 6 Started using =Release 6 notation to indicate that an instruction has been changed but is still present. JR.HB =Release 6, aliased to JALR.HB. SSNOP =Release 6, treated as NOP. Noted that BLTZAL and BGEZAL are removed by Release 6, the special cases NAL=BLTZAL with rs=0 and BAL=BGEZAL with rs=0, remain supported by Release 6. Marked conditional traps with immediate removed by Release 6. Overeager propagation of r31 restriction to non-call instructions removed. Emphasized that unconditional compact CTIs have neither delay slot nor forbidden slot. SDBBP updated for R6P facility to disable if no hardware debug trap handler UFR/UNFR (User-mode FR facility) disallowed in Release 6: changes to CTC1 and CFC1 instructions.
R6U ARM Volume II 6.00 pre-liminary release	February 14, 2014	<ul style="list-style-type: none"> Last minute change: BC1EQZ.fmt and BC1NEZ.fmt test only bit 0, least significant bit, of FPR. <p>Known issues:</p> <ul style="list-style-type: none"> Similar changes to SEL.fmt, SELEQZ.fmt, SELNEZ.fmt not yet made.
post-6.00	February 20, 2014	<ul style="list-style-type: none"> FPU truth consuming instructions (BC1EQZ.fmt, BC1NEZ.fmt, SEL.fmt, SELEQZ.fmt, SELNEZ.fmt) change completed: test bit 0, least-significant-bit, of FPR containing condition.
6.01	December 1, 2014	<ul style="list-style-type: none"> Production Release. Add DVP and EVP instructions for multithreading. Add POP and SOP encoding nomenclature to opcode tables in appendix A
6.02	December 10, 2014	<ul style="list-style-type: none"> JIC format changed from JIC offset(rt) to JIC rt, offset. JIALC format changed from JIALC offset(rt) to JIALC rt, offset. 'offset' removed from NAL format.
6.03	September 4, 2015	<ul style="list-style-type: none"> Fixed many inconsistencies; no functional impact. RDHWR updates for Release 6. WAIT updates for Release 6. CFC1/CTC1 UFR-related text reworded. CFC1/CTC1 FRE-related text added. Added LLX/SCX(32/64) instructions. Jump Register ISA Mode switching text reworded. MisalignedSupport() language in ld/st pseudo-code reworded. Release 6 behaviour added to move-to/from instructions: return 0,nop. TLBINV/TLBINVF description and pseudocode corrected and clarified. ALIGN/DALIGN pseudocode cleaned up; removed redundancy. Removed "Special Considerations" section from B<cond>c Language clarified in PREF/PREFE tables; no functional change.

Revision History

Revision	Date	Description
6.04	November 13, 2015	<p>MIPS32 and MIPS64:</p> <ul style="list-style-type: none">• J/JAL now indicated as deprecated (but not removed).• DVP: Added text indicating that a disabled VP will not be re-enabled for execution on deferred exception.• CACHE/CACHEE: Undefined operations are really NOP.• CMP.condn.fmt: removed fmt related text in description section. .S/.D explicitly encoded.• Fixed minor textual typos in MAXA/MINA.fmt functions.• DERET: Restriction – if executed out of debug mode, then RI, not UNDEFINED.• TLBWR: Updated reference to Random. No longer supported in Release 6.• PCREL instructions: Added PCREL minor opcode table, fixed conditional text bugs in register reference.• BC1F/BC1FL/BC1T/BC1TL: Removed last paragraph of historical information section. These instructions can be immediately preceded by instruction that sets cond. code.• JIALC: Restructured operation section using ‘temp’ to avoid false hazard of link update overwriting source.• LUI: Fixed conditional text errors related to the encoding table. microMIPS appeared in MIPS.• JIALC/JIC: Updated to indicate effect on ‘ISAMode’.• Fixed typo ROUND/TRUNC/FLOOR/CEIL.W.fmt. Range value should be $2^{31}-1$ not $2^{63}-1$. <p>MIPS64 only:</p> <ul style="list-style-type: none">• DMFC0/DMTC0: Now indicates what happens with 32-bit COP0 registers.
6.05	May 20, 2016	<p>MIPS32 and MIPS64:</p> <ul style="list-style-type: none">• RDHWR: Fixed typo in the RDHWR register number table header; rs changed to rd. Changed Double-Width LLX/SCX to Paired LL/SC.• DMTC2: Changed CPR [2, rd, sel] to CP2CPR [Imp1].• WAIT: Fixed a bit range typo.• LSA: Removed the word optional; the scaling shift on rs is not optional.• CACHE: Fixed typo; CACHE has a 9-bit offset.• SYSCALL, TEQ, TGE, and TGEU: If COP0 <i>BadInstr</i> is implemented, the <i>code</i> field may be obtained from <i>BadInstr</i>.• JALR, JALR.HB, JIALC, JIC, JR, and JR.HB: Updated condition for $PC \leftarrow temp$ in the Operation pseudocode. <p>MIPS32:</p> <ul style="list-style-type: none">• Removed the LLX, LLXE, SCX, and SCXE instructions.• Added the LLWP, LLWPE, SCWP, and SCWP instructions. <p>MIPS64:</p> <ul style="list-style-type: none">• Removed the LLDX and SCDX instructions.• Added the LLDP and SCDP instructions.

